



ENT & Plastic Surgery Instruments Catalogue

Table Of Contents

Scalpels & Scalpel Handles	1-8
Suction Tubes	9-12
Liposuction Cannulas	13-48
Scissors	49-98
Forceps	99-108
Needle Holders	109-126
Hand and Foot Surgery	127-132
Delicate Retractors	133-162
Otology	163-188
Rhinology	189-274
Esophagoscopy	189-274
Maxio Facial Surgery	189-274
Oral Instruments	275-328
Tonsil	329-338
Marking & Measuring Instruments	339-342
Wires and Wire Instruments	343
Dermatomes	344-345
Diagnostic	346
Index by Code	347-364
Index Alphabetic	365-378

ENT & Plastic Surgery Instruments



Scalpels

Scalpels



Standard
J-15-063
No. 3
Solid



J-15-064
No. 3
Solid, with scale



J-15-065
No. 3
Solid



J-15-066
No. 3
Plastics



J-15-067
No. 3L
Solid straight

J-15-068
No. 3L
Solid angled

Standard
J-15-069
No. 4
Solid

J-15-100
No. 4
Graduated in mm

J-15-070
No. 4
Plastics

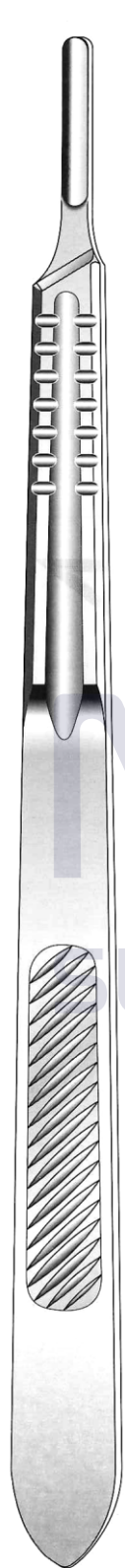

J-15-071
No. 4L
Solid straight

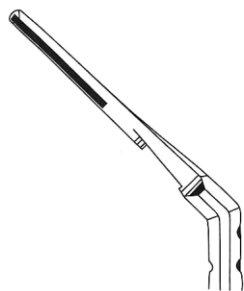

J-15-072
No. 4L
Solid angled



J-15-105
No. 7
Long



J-15-073
No. 7
Solid



J-15-074
No. 7K
Solid



J-15-075
No. 5
Solid



Collin
J-15-076
13.5 cm / 5 1/4"
No. 8
Hollow

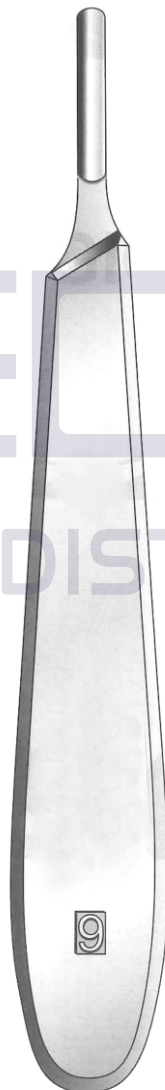

Collin
J-15-077
14.5 cm / 5 3/4"
No. 9
Hollow



Super
J-15-078
No. 10
Hollow



J-15-085
14.5 cm / 5¾"
No. 3
Solid, round, straight



J-15-086
14 cm / 5½"
No. 3
Solid, round, angled



J-15-087
15.5 cm / 6"
No. 3
Round hollow handle
straight



J-15-088
No. 3
Round hollow handle
angled



J-15-150
15.5 cm / 6¼"
No. 3
Hollow golden handle



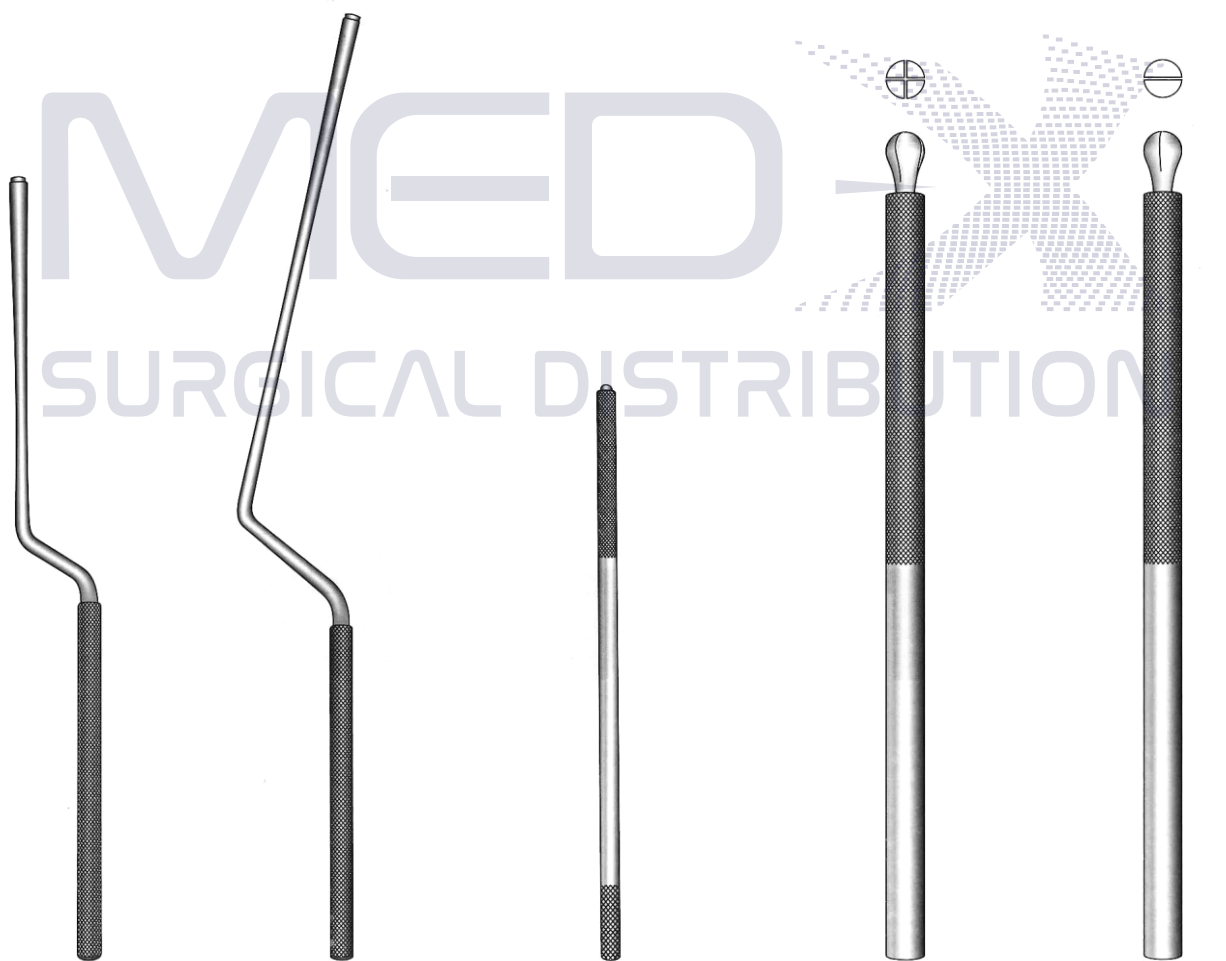

Landolt
J-15-231
21 cm / 8¼"

Landolt
J-15-232
25 cm / 10"

J-15-350 15.5 cm / 6¼"
J-15-352 13 cm / 5½"

Blade Holder
J-15-225
10 cm / 4"
J-15-357
13 cm / 5½"
J-15-358
15.5 cm / 6¼"
5 mm Ø

Blade Holder
J-15-355
10 cm / 4"
J-15-226
13 cm / 5½"
J-15-227
15.5 cm / 6¼"
5 mm Ø

ENT & Plastic Surgery
Instruments



Suction Tubes

Suction Tubes



J-14-041	1.5 mm ϕ
J-14-042	2.0 mm ϕ
J-14-043	2.5 mm ϕ
J-14-044	3.5 mm ϕ

J-14-045	1.5 mm ϕ
J-14-046	2.0 mm ϕ
J-14-047	2.5 mm ϕ
J-14-048	3.5 mm ϕ
With additional side holes	

Adson
J-14-049
21 cm / 8½"
4 mm ϕ

Frazier	
Fr.	mm
J-14-050	06 2
J-14-250	07 2.3
J-14-051	08 2.6
J-14-251	09 3
J-14-052	10 3.3
J-14-252	11 3.6
J-14-053	12 4
J-14-253	14 4.6
J-14-254	16 5
19 cm / 7½"	

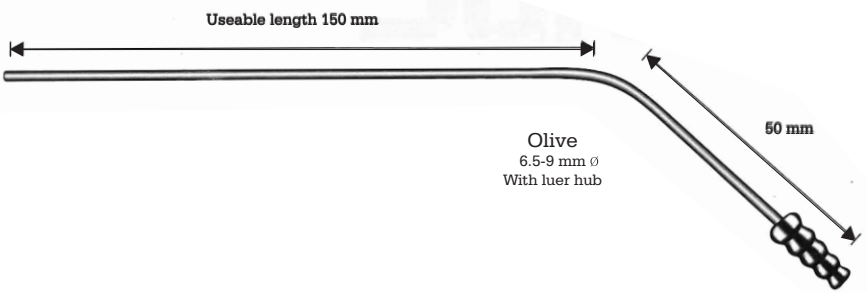

Yasargil

J-14-054	150 mm x 1.5 mm
J-14-055	150 mm x 2.0 mm
J-14-057	150 mm x 2.5 mm
J-14-058	150 mm x 3.5 mm
11 cm / 4¼"	

Frazier
J-14-260
9 Fr. 3 mm



Frazier	Fr.	
J-14-130	6	2 mm
J-14-131	7	2.3 mm
J-14-132	8	2.6 mm
J-14-133	9	3 mm
J-14-134	10	3.3 mm
J-14-135	11	3.6 mm
J-14-136	12	4 mm
J-14-137	14	4.6 mm
J-14-138	16	5 mm

Ear suction tube

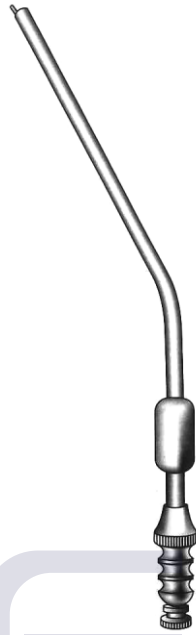

Frazier	Fr.	
J-14-140	6	2 mm
J-14-141	7	2.3 mm
J-14-142	8	2.6 mm
J-14-143	9	3 mm
J-14-144	10	3.3 mm
J-14-145	11	3.6 mm
J-14-146	12	4 mm
J-14-147	14	4.6 mm
J-14-148	16	5 mm



Unit Auditive	Inside	Outside
J-14-150	1 mm	2 mm
J-14-151	1.2 mm	2.2 mm
J-14-152	1.5 mm	2.5 mm
J-14-153	2 mm	3 mm

14.5 cm / 5 3/4"

SURGICAL DISTRIBUTION

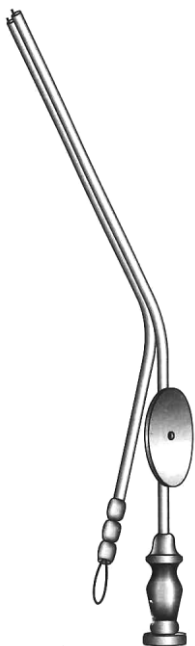

House Suction Irrigating Tubes	
J-14-160	5 French
J-14-161	7 French
J-14-162	8 French
J-14-163	10 French
J-14-164	12 French
J-14-165	14 French

Ear suction tube



Baron	
J-14-170	3 French
J-14-171	5 French
J-14-172	7 French with finger cut off

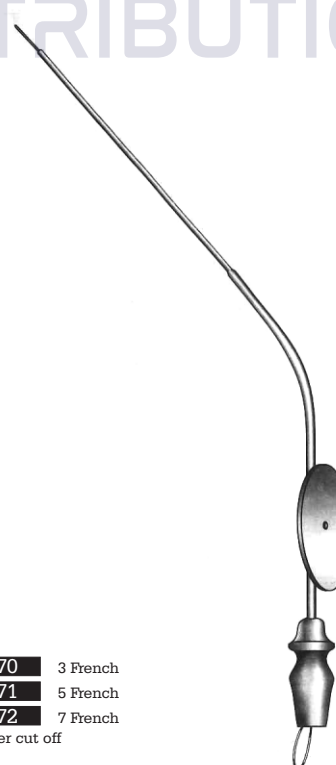

Baron	
J-14-180	3 French
J-14-185	5 French
J-14-190	7 French

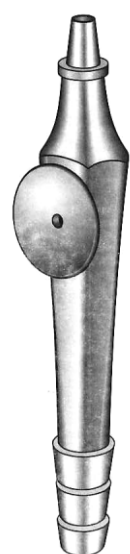
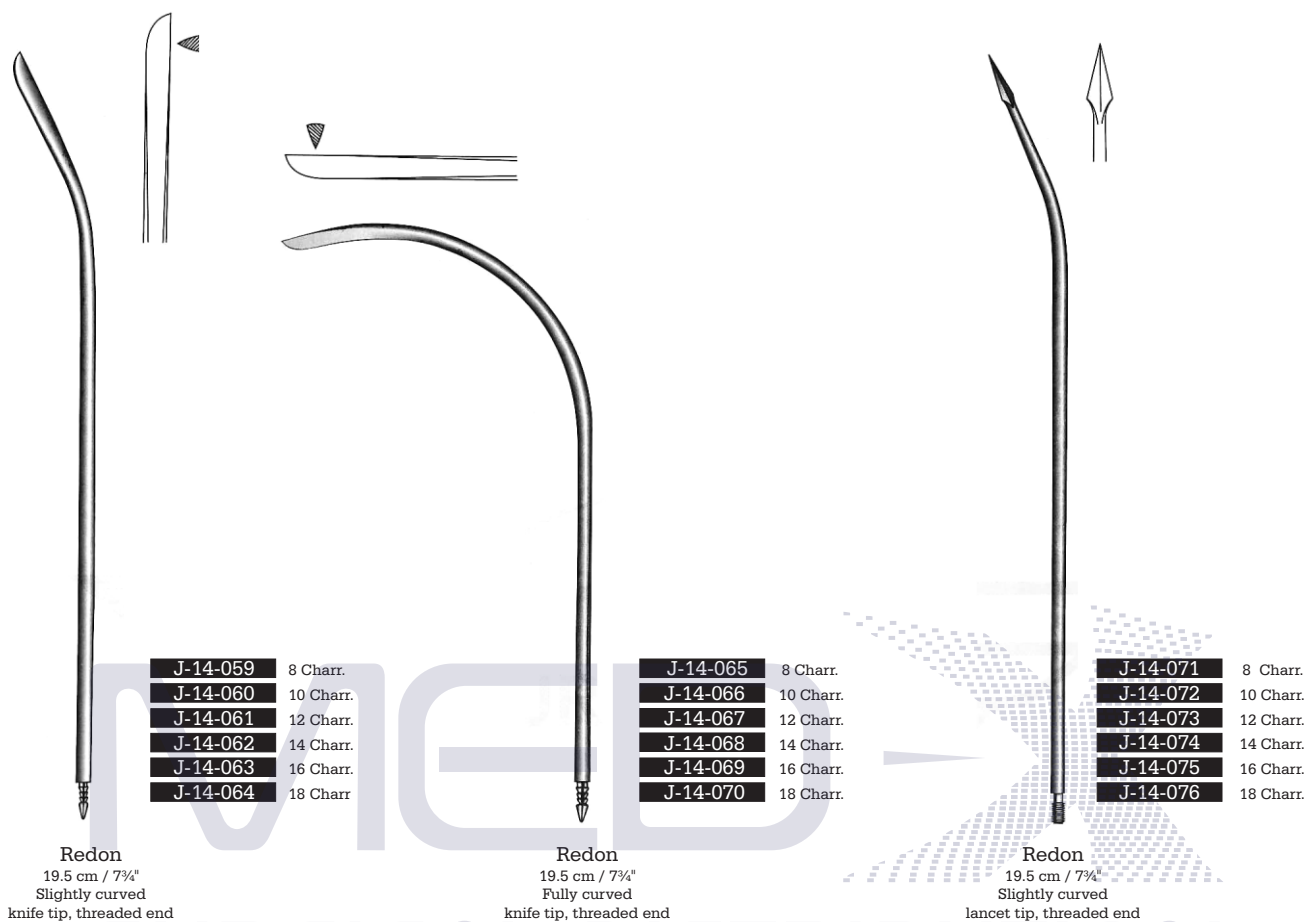

Suction Adapter
J-14-315



Suction Tube
J-14-330
Fig. 1



Suction Tube
J-14-331
Fig. 2



Suction Tube
J-14-332
Fig. 3



Suction Tube
J-14-333
Fig. 4



Suction Tube
J-14-334
Fig. 5

ENT & Plastic Surgery
Instruments



Lipo Suction

Lipo Suction

Lipo Suction



One central hole



J-07-001	J-07-010	J-07-020	J-07-030	J-07-040	J-07-050	J-07-060	J-07-070
J-07-002	J-07-011	J-07-021	J-07-031	J-07-041	J-07-051	J-07-061	J-07-071
J-07-003	J-07-012	J-07-022	J-07-032	J-07-042	J-07-052	J-07-062	J-07-072
Luer Lock	Luer Lock	Luer Lock	Luer Lock	Luer Lock	Luer Lock	Luer Lock	Luer Lock
J-07-005	J-07-015	J-07-025	J-07-035	J-07-045	J-07-055	J-07-065	J-07-075
J-07-006	J-07-016	J-07-026	J-07-036	J-07-046	J-07-056	J-07-066	J-07-076
J-07-007	J-07-017	J-07-027	J-07-037	J-07-047	J-07-057	J-07-067	J-07-077
Sure Lock	Sure Lock	Sure Lock	Sure Lock	Sure Lock	Sure Lock	Sure Lock	Sure Lock
5 cm / 2"	5 cm / 2"	5 cm / 2"	5 cm / 2"	10 cm / 4"	10 cm / 4"	10 cm / 4"	10 cm / 4"
1mm Ø, 1 Hole	1.7 mm Ø, 1 Hole	2 mm Ø, 1 Hole	3 mm Ø, 1 Hole	1 mm Ø, 1 Hole	1.7 mm Ø, 1 Hole	2 mm Ø, 1 Hole	3 mm Ø, 1 Hole
Stainless Steel	Stainless Steel	Stainless Steel	Stainless Steel	Stainless Steel	Stainless Steel	Stainless Steel	Stainless Steel



J-07-080
J-07-081
J-07-082
 Luer Lock
 J-07-085
J-07-086
J-07-087
 Sure Lock
 15 cm / 6"
 1 mm Ø, 1 Hole
 Stainless Steel



J-07-090
J-07-091
J-07-092
 Luer Lock
 J-07-095
J-07-096
J-07-097
 Sure Lock
 15 cm / 6"
 Ø 1.7 mm, 1 Hole
 Stainless Steel



J-07-100
J-07-101
J-07-102
 Luer Lock
 J-07-105
J-07-106
J-07-107
 Sure Lock
 15 cm / 6"
 2 mm Ø, 1 Hole
 Stainless Steel



J-07-110
J-07-111
J-07-112
 Luer Lock
 J-07-115
J-07-116
J-07-117
 Sure Lock
 15 cm / 6"
 3 mm Ø, 1 Hole
 Stainless Steel



MED
SURGICAL DISTRIBUTION



- J-07-120
- J-07-121**
- J-07-122
- Luer Lock
- J-07-125
- J-07-126**
- J-07-127
- Luer Lock Special
- 20 cm / 8"
- J-07-130
- J-07-131**
- J-07-132
- Luer Lock
- J-07-135
- J-07-136**
- J-07-137
- Sure Lock
- 30 cm / 11¾"
- 3 mm Ø, One Central Hole
- Point with Hole
- Stainless Steel

- J-07-140
- J-07-141**
- J-07-142
- Luer Lock
- J-07-145
- J-07-146**
- J-07-147
- Luer Lock Special
- 30 cm / 11¾"
- J-07-150
- J-07-151**
- J-07-152
- Luer Lock
- J-07-155
- J-07-156**
- J-07-157
- Sure Lock
- 35 cm / 13¾"
- 6 mm Ø
- Stainless Steel



J-07-160
J-07-161
J-07-162
 Luer Lock
 J-07-165
J-07-166
J-07-167
 Sure Lock
 10 cm / 4"
 1 mm Ø, 2 Holes
 Stainless Steel

J-07-170
J-07-171
J-07-172
 Luer Lock
 J-07-175
J-07-176
J-07-177
 Sure Lock
 10 cm / 4"
 2 mm Ø, 2 Holes
 Stainless Steel

J-07-180
J-07-181
J-07-182
 Luer Lock
 J-07-185
J-07-186
J-07-187
 Sure Lock
 10 cm / 4"
 3 mm Ø, 2 Holes
 Stainless Steel

J-07-190
J-07-191
J-07-192
 Luer Lock
 J-07-195
J-07-196
J-07-197
 Sure Lock
 15 cm / 6"
 2 mm Ø, 2 Holes
 Stainless Steel

J-07-200
J-07-201
J-07-202
 Luer Lock
 J-07-205
J-07-206
J-07-207
 Sure Lock
 15 cm / 6"
 3 mm Ø, 2 Holes
 Stainless Steel

J-07-210
J-07-211
J-07-212
 Luer Lock
 J-07-215
J-07-216
J-07-217
 Sure Lock
 15 cm / 6"
 4 mm Ø, 2 Holes
 Stainless Steel

J-07-220
J-07-221
J-07-222
 Luer Lock
 J-07-225
J-07-226
J-07-227
 Sure Lock
 14 cm / 5 1/4"
 1 mm Ø, 2 Holes
 Stainless Steel



One central hole
two lateral hole



- J-07-230
- J-07-231
- J-07-232
- Luer Lock
- J-07-235
- J-07-236
- J-07-237
- Suer Lock
- 10 cm / 4"
- J-07-240
- J-07-241
- J-07-242
- Luer Lock
- J-07-245
- J-07-246
- J-07-247
- Suer Lock
- 15 cm / 6"
- 1.7 mm Ø
- Stainless Steel



- J-07-250
- J-07-251
- J-07-252
- Luer Lock
- J-07-255
- J-07-256
- J-07-257
- Suer Lock
- 10 cm / 4"
- J-07-260
- J-07-261
- J-07-262
- Luer Lock
- J-07-265
- J-07-266
- J-07-267
- Suer Lock
- 15 cm / 6"
- 2 mm Ø
- Stainless Steel



- J-07-270
- J-07-271
- J-07-272
- Luer Lock
- J-07-275
- J-07-276
- J-07-277
- Suer Lock
- 10 cm / 4"
- J-07-280
- J-07-281
- J-07-282
- Luer Lock
- J-07-285
- J-07-286
- J-07-287
- Suer Lock
- 15 cm / 6"
- 2.5 mm Ø
- Stainless Steel



- J-07-290
- J-07-291
- J-07-292
- Luer Lock
- J-07-295
- J-07-296
- J-07-297
- Suer Lock
- 20 cm / 8"
- J-07-300
- J-07-301
- J-07-302
- Luer Lock
- J-07-305
- J-07-306
- J-07-307
- Suer Lock
- 30 cm / 11 3/4"
- 3 mm Ø
- Stainless Steel



- J-07-310
- J-07-311
- J-07-312
- Luer Lock
- J-07-315
- J-07-316
- J-07-317
- Suer Lock
- 20 cm / 8"
- J-07-320
- J-07-321
- J-07-322
- Luer Lock
- J-07-325
- J-07-326
- J-07-327
- Suer Lock
- 30 cm / 11 3/4"
- 4 mm Ø
- Stainless Steel

MED
SURGICAL DISTRIBUTION

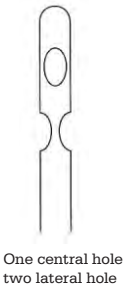

J-07-330
J-07-331
J-07-332
 Luer Lock
J-07-335
J-07-336
J-07-337
 Sure Lock
 30 cm / 11¾"
 5 mm Ø, 3 Holes
 Stainless Steel

J-07-340
J-07-341
J-07-342
 Luer Lock
J-07-345
J-07-346
J-07-347
 Sure Lock
 30 cm / 11¾"
 6 mm Ø, 3 Holes
 Stainless Steel

J-07-350
J-07-351
J-07-352
 Luer Lock
J-07-355
J-07-356
J-07-357
 Sure Lock
 30 cm / 11¾"
 7 mm Ø, 3 Holes
 Stainless Steel

J-07-360
J-07-361
J-07-362
 Luer Lock
J-07-365
J-07-366
J-07-367
 Sure Lock
 30 cm / 11¾"
 8 mm Ø, 3 Holes
 Handle Connector
 Stainless Steel



Two lateral hole
One central hole



J-07-370
J-07-371
J-07-372
Luer Lock
J-07-375
J-07-376
J-07-377
Sure Lock
10 cm / 4"
J-07-380
J-07-381
J-07-382
Luer Lock
J-07-385
J-07-386
J-07-387
Sure Lock
15 cm / 6"
1.7 mm Ø
3 Holes
Stainless Steel



J-07-390
J-07-391
J-07-392
Luer Lock
J-07-395
J-07-396
J-07-397
Sure Lock
10 cm / 4"
J-07-400
J-07-401
J-07-402
Luer Lock
J-07-405
J-07-406
J-07-407
Sure Lock
15 cm / 6"
2 mm Ø
3 Holes
Stainless Steel



J-07-410
J-07-411
J-07-412
Luer Lock
J-07-415
J-07-416
J-07-417
Sure Lock
10 cm / 4"
J-07-420
J-07-421
J-07-422
Luer Lock
J-07-425
J-07-426
J-07-427
Sure Lock
15 cm / 6"
2.5 mm Ø
3 Holes
Stainless Steel



J-07-430
J-07-431
J-07-432
Luer Lock
J-07-435
J-07-436
J-07-437
Sure Lock
20 cm / 8"
J-07-440
J-07-441
J-07-442
Luer Lock
J-07-445
J-07-446
J-07-447
Sure Lock
30 cm / 11 1/4"
3 mm Ø
3 Holes
Stainless Steel

MEDIX
SURGICAL DISTRIBUTION



Two lateral hole
 One central hole



J-07-450
J-07-451
J-07-452
 Luer Lock
 J-07-455
J-07-456
J-07-457
 Sure Lock
 30 cm / 11¼"
 4 mm Ø, 3 Hole
 Stainless Steel

J-07-460
J-07-461
J-07-462
 Luer Lock
 J-07-465
J-07-466
J-07-467
 Sure Lock
 30 cm / 11¼"
 5 mm Ø, 3 Hole
 Stainless Steel

J-07-470
J-07-471
J-07-472
 Luer Lock
 J-07-475
J-07-476
J-07-477
 Sure Lock
 30 cm / 11¼"
 6 mm Ø, 3 Hole
 Stainless Steel

J-07-480
J-07-481
J-07-482
 Luer Lock
 J-07-485
J-07-486
J-07-487
 Sure Lock
 30 cm / 11¼"
 8 mm Ø, 3 Hole
 Stainless Steel



Three holes, diagonal



MED
SURGICAL DISTRIBUTION



J-07-490
J-07-491
J-07-492
Luer Lock
J-07-495
J-07-496
J-07-497
Sure Lock
10 cm / 4"
2 mm Ø, 3 Hole
Stainless Steel



J-07-500
J-07-501
J-07-502
Luer Lock
J-07-505
J-07-506
J-07-507
Sure Lock
20 cm / 8"
J-07-510
J-07-511
J-07-512
Luer Lock
J-07-515
J-07-516
J-07-517
Sure Lock
30 cm / 11¼"
3 mm Ø, 3 Holes
Stainless Steel



J-07-520
J-07-521
J-07-522
Luer Lock
J-07-525
J-07-526
J-07-527
Sure Lock
20 cm / 8"
J-07-530
J-07-531
J-07-532
Luer Lock
J-07-535
J-07-536
J-07-537
Sure Lock
40 cm / 15¾"
4 mm Ø, 3 Holes
Stainless Steel



J-07-540
J-07-541
J-07-542
Luer Lock
J-07-545
J-07-546
J-07-547
Sure Lock
30 cm / 11¼"
5 mm Ø, 3 Holes
Stainless Steel



J-07-550
J-07-551
J-07-552
Luer Lock
J-07-555
J-07-556
J-07-557
Sure Lock
30 cm / 11¼"
6 mm Ø, 3 Holes
Stainless Steel

J-07-560
J-07-561
J-07-562
Luer Lock
J-07-565
J-07-566
J-07-567
Sure Lock
15 cm / 6"
1 mm Ø, 3 Holes
Stainless Steel



J-07-570
J-07-571
J-07-572
 Luer Lock
J-07-575
J-07-576
J-07-577
 Sure Lock
 30 cm / 11¾"
 4 mm Ø
 1 Central Hole
 2 Lateral Holes
 Stainless Steel



J-07-580
J-07-581
J-07-582
 Luer Lock
J-07-585
J-07-586
J-07-587
 Sure Lock
 30 cm / 11¾"
 5 mm Ø
 1 Central Hole
 2 Lateral Holes
 Stainless Steel

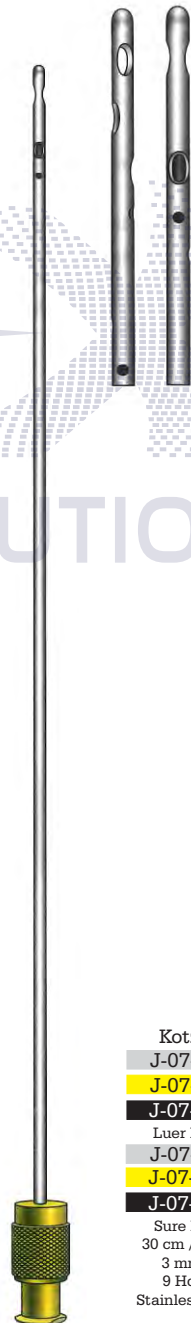

Kotzur
J-07-590
J-07-591
J-07-592
 Luer Lock
J-07-595
J-07-596
J-07-597
 Sure Lock
 30 cm / 11¾"
 3 mm Ø
 9 Holes
 Stainless Steel





Entner
J-07-600
J-07-601
J-07-602
Luer Lock
J-07-605
J-07-606
J-07-607
Sure Lock
15 cm / 6"
2 mm Ø, 8 Holes
Stainless Steel



Entner
J-07-610
J-07-611
J-07-612
Luer Lock
J-07-615
J-07-616
J-07-617
Sure Lock
15 cm / 6"
2 mm Ø, 16 Holes
Stainless Steel



Entner
J-07-620
J-07-621
J-07-622
Luer Lock
J-07-625
J-07-626
J-07-627
Sure Lock
15 cm / 6"
2 mm Ø, 18 Holes
Stainless Steel



Entner
J-07-630
J-07-631
J-07-632
Luer Lock
J-07-635
J-07-636
J-07-637
Sure Lock
15 cm / 6"
3 mm Ø, 18 Holes
Stainless Steel

MED
SURGICAL DISTRIBUTION



Entner
 J-07-640
J-07-641
J-07-642
 Luer Lock
 J-07-645
J-07-646
J-07-647
 Sure Lock
 20 cm / 8"
 3 mm Ø, 22 Holes
 Stainless Steel

Entner
 J-07-650
J-07-651
J-07-652
 Luer Lock
 J-07-655
J-07-656
J-07-657
 Sure Lock
 20 cm / 8"
 3.5 mm Ø, 22 Holes
 Stainless Steel

Entner
 J-07-660
J-07-661
J-07-662
 Luer Lock
 J-07-665
J-07-666
J-07-667
 Sure Lock
 20 cm / 8"
 4 mm Ø, 22 Holes
 Stainless Steel

Entner
 J-07-670
J-07-671
J-07-672
 Luer Lock
 J-07-675
J-07-676
J-07-677
 Sure Lock
 30 cm / 11 3/4"
 3 mm Ø, 30 Holes
 Stainless Steel

Entner
 J-07-680
J-07-681
J-07-682
 Luer Lock
 J-07-685
J-07-686
J-07-687
 Sure Lock
 30 cm / 11 3/4"
 4 mm Ø, 30 Holes
 Stainless Steel



Entner
J-07-690
J-07-691
J-07-692
 Luer Lock
J-07-695
J-07-696
J-07-697
 Sure Lock
 10 cm / 4"
 2 mm Ø, 8 Holes
 Stainless Steel

Entner
J-07-700
J-07-701
J-07-702
 Luer Lock
J-07-705
J-07-706
J-07-707
 Sure Lock
 20 cm / 8"
 3 mm Ø, 22 Holes
 Stainless Steel



1.5 mm Hole

2 mm Hole

1.5 mm Hole

2 mm Hole

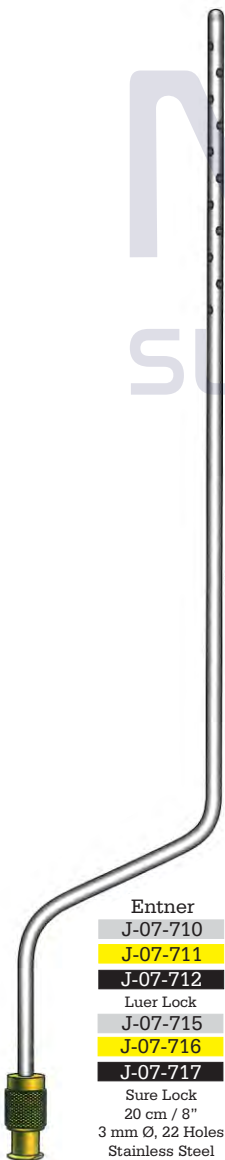
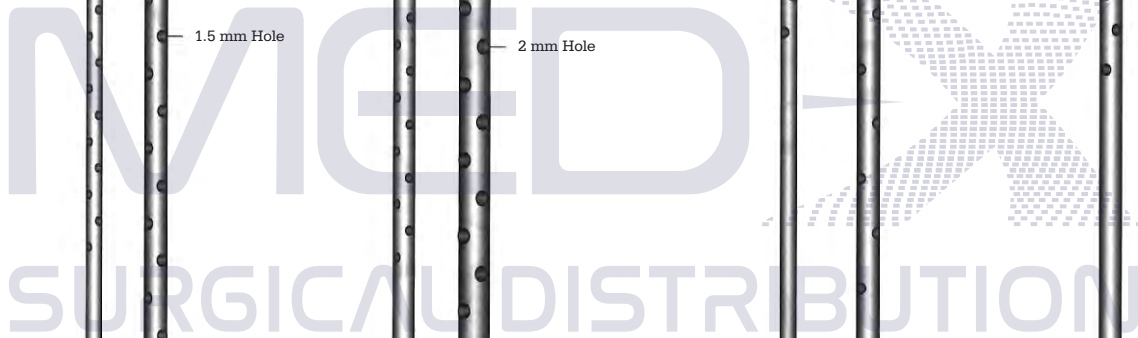

Entner
 J-07-710
J-07-711
 J-07-712
 Luer Lock
 J-07-715
J-07-716
J-07-717
 Sure Lock
 20 cm / 8"
 3 mm Ø, 22 Holes
 Stainless Steel



Entner
 J-07-720
J-07-721
 J-07-722
 Luer Lock
 J-07-725
J-07-726
J-07-727
 Sure Lock
 20 cm / 8"
 4 mm Ø, 22 Holes
 Stainless Steel



Entner
 J-07-730
J-07-731
 J-07-732
 Luer Lock
 J-07-735
J-07-736
J-07-737
 Sure Lock
 30 cm / 11 1/4"
 3 mm Ø, 30 Holes
 Stainless Steel

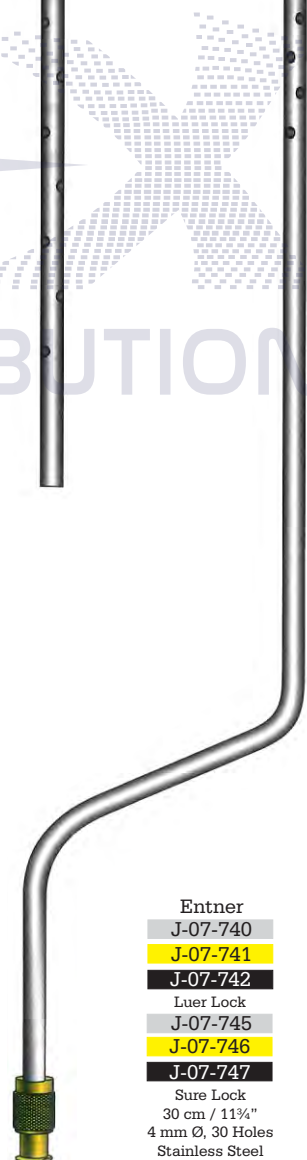





Entner
 J-07-740
J-07-741
 J-07-742
 Luer Lock
 J-07-745
J-07-746
J-07-747
 Sure Lock
 30 cm / 11 1/4"
 4 mm Ø, 30 Holes
 Stainless Steel

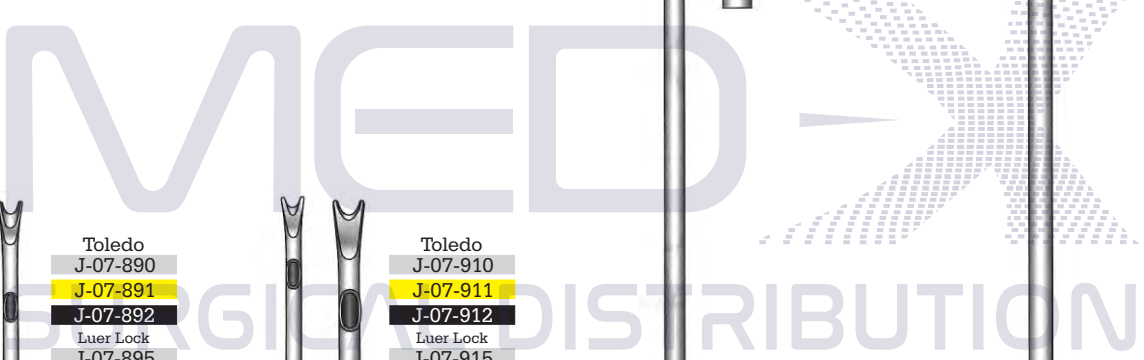

						
Mercedes J-07-750	Mercedes J-07-760	Mercedes J-07-770	Mercedes J-07-790	Mercedes J-07-810	Mercedes J-07-830	Mercedes J-07-860
J-07-751	J-07-761	J-07-771	J-07-791	J-07-811	J-07-831	J-07-861
J-07-752	J-07-762	J-07-772	J-07-792	J-07-812	J-07-832	J-07-862
Luer Lock	Luer Lock	Luer Lock	Luer Lock	Luer Lock	Luer Lock	Luer Lock
J-07-755	J-07-765	J-07-775	J-07-795	J-07-815	J-07-835	J-07-865
J-07-756	J-07-766	J-07-776	J-07-796	J-07-816	J-07-836	J-07-866
J-07-757	J-07-767	J-07-777	J-07-797	J-07-817	J-07-837	J-07-867
Sure Lock	Sure Lock	Sure Lock	Sure Lock	Sure Lock	Sure Lock	Sure Lock
10 cm / 4"	15 cm / 6"	10 cm / 4"	10 cm / 4"	10 cm / 4"	10 cm / 4"	10 cm / 4"
1 mm Ø, 3 Slots	1.5 mm Ø, 3 Slots					
Stainless Steel	Stainless Steel					
		J-07-780	J-07-800	J-07-820	J-07-840	J-07-870
		J-07-781	J-07-801	J-07-821	J-07-841	J-07-871
		J-07-782	J-07-802	J-07-822	J-07-842	J-07-872
		Luer Lock	Luer Lock	Luer Lock	Luer Lock	Luer Lock
		J-07-785	J-07-805	J-07-825	J-07-845	J-07-875
		J-07-786	J-07-806	J-07-826	J-07-846	J-07-876
		J-07-787	J-07-807	J-07-827	J-07-847	J-07-877
		Sure Lock	Sure Lock	Sure Lock	Sure Lock	Sure Lock
		15 cm / 6"	15 cm / 6"	15 cm / 6"	15 cm / 6"	15 cm / 6"
		1.7 mm Ø	2 mm Ø	2.5 mm Ø	3 mm Ø	4 mm Ø
		Three lateral holes	Three lateral holes	Three lateral holes	Three lateral holes	Three lateral holes
		Stainless Steel	Stainless Steel	Stainless Steel	Stainless Steel	Stainless Steel
					J-07-850	J-07-880
					J-07-851	J-07-881
					J-07-852	J-07-882
					Luer Lock	Luer Lock
					J-07-855	J-07-885
					J-07-856	J-07-886
					J-07-857	J-07-887
					Sure Lock	Sure Lock
					25 cm / 10"	25 cm / 10"
					3 mm Ø	4 mm Ø
					Three lateral holes	Three lateral holes
					Stainless Steel	Stainless Steel

 <p>Toledo J-07-890 J-07-891 J-07-892 Luer Lock J-07-895 J-07-896 J-07-897 Sure Lock 5 cm / 2" J-07-900 J-07-901 J-07-902 Luer Lock J-07-905 J-07-906 J-07-907 Sure Lock 15 cm / 6" 2 mm Ø 1 Central Hole Stainless Steel</p>	 <p>Toledo J-07-910 J-07-911 J-07-912 Luer Lock J-07-915 J-07-916 J-07-917 Sure Lock 5 cm / 2" J-07-920 J-07-921 J-07-922 Luer Lock J-07-925 J-07-926 J-07-927 Sure Lock 15 cm / 6" J-07-930 J-07-931 J-07-932 Luer Lock J-07-935 J-07-936 J-07-937 Sure Lock 25 cm / 10" J-07-940 J-07-941 J-07-942 Luer Lock J-07-945 J-07-946 J-07-947 Sure Lock 30 cm / 11 3/4" 3 mm Ø 1 Central Hole Stainless Steel</p>	 <p>Toledo J-07-950 J-07-951 J-07-952 Luer Lock J-07-955 J-07-956 J-07-957 Sure Lock 5 cm / 2" J-07-960 J-07-961 J-07-962 Luer Lock J-07-965 J-07-966 J-07-967 Sure Lock 25 cm / 10" J-07-970 J-07-971 J-07-972 Luer Lock J-07-975 J-07-976 J-07-977 Sure Lock 30 cm / 11 3/4" 4 mm Ø 1 Central Hole Stainless Steel</p>	 <p>Toledo J-07-980 J-07-981 J-07-982 Luer Lock J-07-985 J-07-986 J-07-987 Sure Lock 30 cm / 11 3/4" 5 mm Ø 1 Central Hole Stainless Steel</p>
---	---	--	--



Transfer Adaptor
J-07-1000
J-07-1001
J-07-1002
Luer Lock
4.5 cm / 1 3/4"
4 mm Ø
Stainless Steel



Transfer Adaptor
J-07-1010
J-07-1011
J-07-1012
Sure Lock
4.5 cm / 1 3/4"
4 mm Ø
Stainless Steel



Handle for Cannulas
J-07-1020
13 mm Ø
Tube connection



Handle for Cannulas
J-07-1030
13 mm Ø
Tube connection

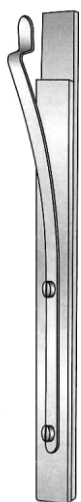

Stop (Lock)
J-07-1040
13 cm / 5 1/4"
Stainless steel stop (lock)
for establishing a vacuum
in the syringe



Adaptor
J-07-1050
5 cm / 2"
Luer-Lock



Adaptor
J-07-1060
5 cm / 2"
Sure Lock

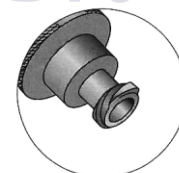

Holding Device
J-07-1070
J-07-1071
J-07-1072
Luer Lock
J-07-1075
J-07-1076
J-07-1077
Sure Lock
Length 34.7 mm
Outer Ø 6 mm
Internal Ø 4 mm
Stainless Steel



Transfer Adaptor

- J-07-1080
- J-07-1081**
- J-07-1082

Luer Lock
 3 cm / 1¼"
 Stainless Steel



Transfer Adaptor

- J-07-1090
- J-07-1091**
- J-07-1092

Sure Lock
 7.5 cm / 3"
 Stainless Steel



Holding Device

- J-07-1100
- J-07-1101**
- J-07-1102

Luer Lock
 Ø 40 mm
 with Luer-Lock
 Stainless Steel



Holding Device

- J-07-1110
- J-07-1111**
- J-07-1112

Ø 40 mm
 with Sure Lock
 Stainless Steel

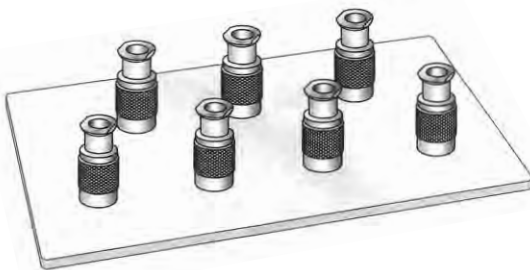

Transfer Adaptor

- J-07-1120
- J-07-1121**
- J-07-1122

Luer Lock
 3 cm / 1¼"
 Stainless Steel

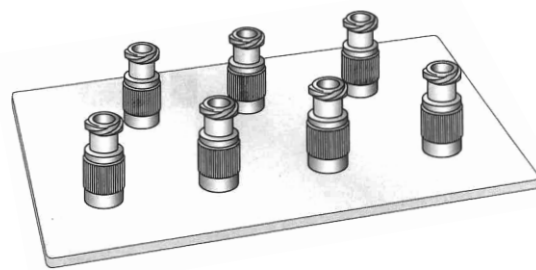

Transfer Adaptor

- J-07-1130
- J-07-1131**
- J-07-1132

Sure Lock
 3 cm / 1¼"
 Stainless Steel



One central hole

MEDIX
SURGICAL DISTRIBUTION

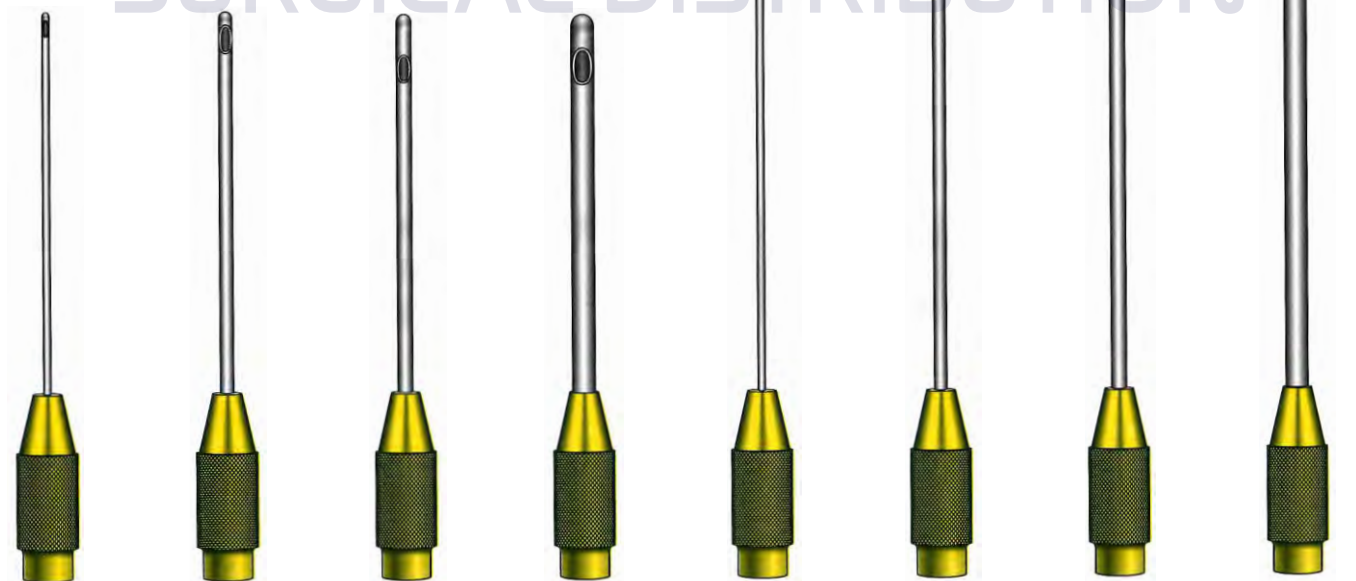

J-07-1140	J-07-1150	J-07-1160	J-07-1170	J-07-1180	J-07-1190	J-07-1200	J-07-1210
J-07-1141	J-07-1151	J-07-1161	J-07-1171	J-07-1181	J-07-1191	J-07-1201	J-07-1211
J-07-1142	J-07-1152	J-07-1162	J-07-1172	J-07-1182	J-07-1192	J-07-1202	J-07-1212
5 cm / 2"	5 cm / 2"	5 cm / 2"	5 cm / 2"	10 cm / 4"	10 cm / 4"	10 cm / 4"	10 cm / 4"
1 mm Ø, 1 Hole	1.7 mm Ø, 1 Hole	2 mm Ø, 1 Hole	3 mm Ø, 1 Hole	1 mm Ø, 1 Hole	1.7 mm Ø, 1 Hole	2 mm Ø, 1 Hole	3 mm Ø, 1 Hole
Stainless Steel	Stainless Steel	Stainless Steel	Stainless Steel	Stainless Steel	Stainless Steel	Stainless Steel	Stainless Steel



J-07-1220
J-07-1221
J-07-1222
 15 cm / 6"
 1 mm Ø, 1 Hole
 Stainless Steel



J-07-1230
J-07-1231
J-07-1232
 15 cm / 6"
 1.7 mm Ø
 Stainless Steel



J-07-1240
J-07-1241
J-07-1242
 15 cm / 6"
 2 mm Ø, 1 Hole
 Stainless Steel



J-07-1250
J-07-1251
J-07-1252
 15 cm / 6"
 3 mm Ø, 1 Hole
 Stainless Steel





MED
SURGICAL DISTRIBUTION

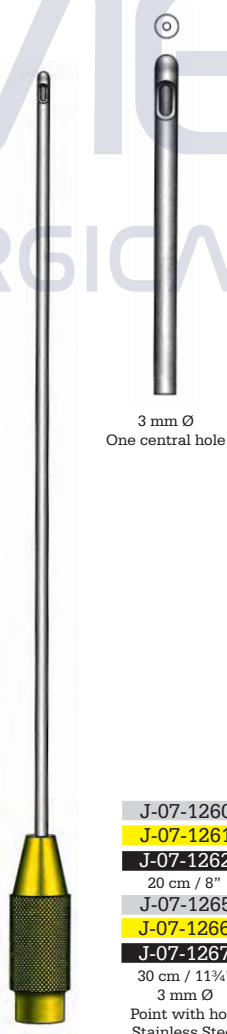

J-07-1260

J-07-1261

J-07-1262

20 cm / 8"

J-07-1265

J-07-1266

J-07-1267

30 cm / 11¾"

3 mm Ø

Point with hole
Stainless Steel



J-07-1270

J-07-1271

J-07-1272

30 cm / 11¾"

J-07-1275

J-07-1276

J-07-1277

35 cm / 13¾"

6 mm Ø

Stainless Steel



J-07-1280
J-07-1281
J-07-1282
 10 cm / 4"
 1 mm Ø, 2 Holes
 Stainless Steel

J-07-1290
J-07-1291
J-07-1292
 10 cm / 4"
 2 mm Ø, 2 Holes
 Stainless Steel

J-07-1300
J-07-1301
J-07-1302
 10 cm / 4"
 3 mm Ø, 2 Holes
 Stainless Steel

J-07-1310
J-07-1311
J-07-1312
 15 cm / 6"
 2 mm Ø, 2 Holes
 Stainless Steel

J-07-1320
J-07-1321
J-07-1322
 15 cm / 6"
 3 mm Ø, 2 Holes
 Stainless Steel

J-07-1330
J-07-1331
J-07-1332
 15 cm / 6"
 4 mm Ø, 2 Holes
 Stainless Steel

J-07-1340
J-07-1341
J-07-1342
 14 cm / 5 3/4"
 1 mm Ø, 2 Holes
 Stainless Steel





J-07-1400
J-07-1401
J-07-1402
 30 cm / 11¾"
 5 mm Ø, 3 Holes
 Stainless Steel

J-07-1410
J-07-1411
J-07-1412
 30 cm / 11¾"
 6 mm Ø, 3 Holes
 Stainless Steel

J-07-1420
J-07-1421
J-07-1422
 30 cm / 11¾"
 7 mm Ø, 3 Holes
 Stainless Steel

J-07-1430
J-07-1431
J-07-1432
 30 cm / 11¾"
 8 mm Ø, 3 Holes
 Stainless Steel



Two lateral hole
One central hole

MED
SURGICAL DISTRIBUTION



J-07-1440
J-07-1441
J-07-1442
10 cm / 4"
J-07-1445
J-07-1446
J-07-1447
15 cm / 6"
1.7 mm Ø
3 Holes
Stainless Steel



J-07-1450
J-07-1451
J-07-1452
10 cm / 4"
J-07-1455
J-07-1456
J-07-1457
15 cm / 6"
2 mm Ø
3 Holes
Stainless Steel



J-07-1460
J-07-1461
J-07-1462
10 cm / 4"
J-07-1465
J-07-1466
J-07-1467
15 cm / 6"
2.5 mm Ø
3 Holes
Stainless Steel



J-07-1470
J-07-1471
J-07-1472
20 cm / 8"
J-07-1475
J-07-1476
J-07-1477
30 cm / 11¾"
3 mm Ø
3 Holes
Stainless Steel



J-07-1480
J-07-1481
 J-07-1482
 30 cm / 11¾"
 4 mm Ø
 3 Holes
 Stainless Steel



J-07-1490
J-07-1491
 J-07-1492
 30 cm / 11¾"
 5 mm Ø
 3 Holes
 Stainless Steel



J-07-1500
J-07-1501
 J-07-1502
 30 cm / 11¾"
 6 mm Ø
 3 Holes
 Stainless Steel



J-07-1510
J-07-1511
 J-07-1512
 30 cm / 11¾"
 8 mm Ø
 3 Holes
 Stainless Steel



Two lateral hole
 One central hole

MED 
 SURGICAL DISTRIBUTION



Three holes, diagonal



J-07-1520
J-07-1521
J-07-1522
10 cm / 4"
2 mm Ø, 3 Hole
Stainless Steel

J-07-1530
J-07-1531
J-07-1532
20cm / 8"
J-07-1535
J-07-1536
J-07-1537
30 cm / 11¼"
3 mm Ø, 3 Holes
Stainless Steel

J-07-1540
J-07-1541
J-07-1542
30 cm 11¾"
J-07-1545
J-07-1546
J-07-1547
40 cm / 15¾"
4 mm Ø, 3 Holes
Stainless Steel

J-07-1550
J-07-1551
J-07-1552
30 cm / 11¼"
5 mm Ø, 3 Holes
Stainless Steel

J-07-1560
J-07-1561
J-07-1562
30 cm / 11¼"
6 mm Ø, 3 Holes
Stainless Steel

J-07-1570
J-07-1571
J-07-1572
15 cm / 6"
1 mm Ø, 3 Holes
Stainless Steel



J-07-1700
J-07-1701
J-07-1702
10 cm / 4"
2 mm Ø, 8 Holes
Stainless Steel



J-07-1710
J-07-1711
J-07-1712
20 cm / 8"
3 mm Ø, 22 Holes
Stainless Steel

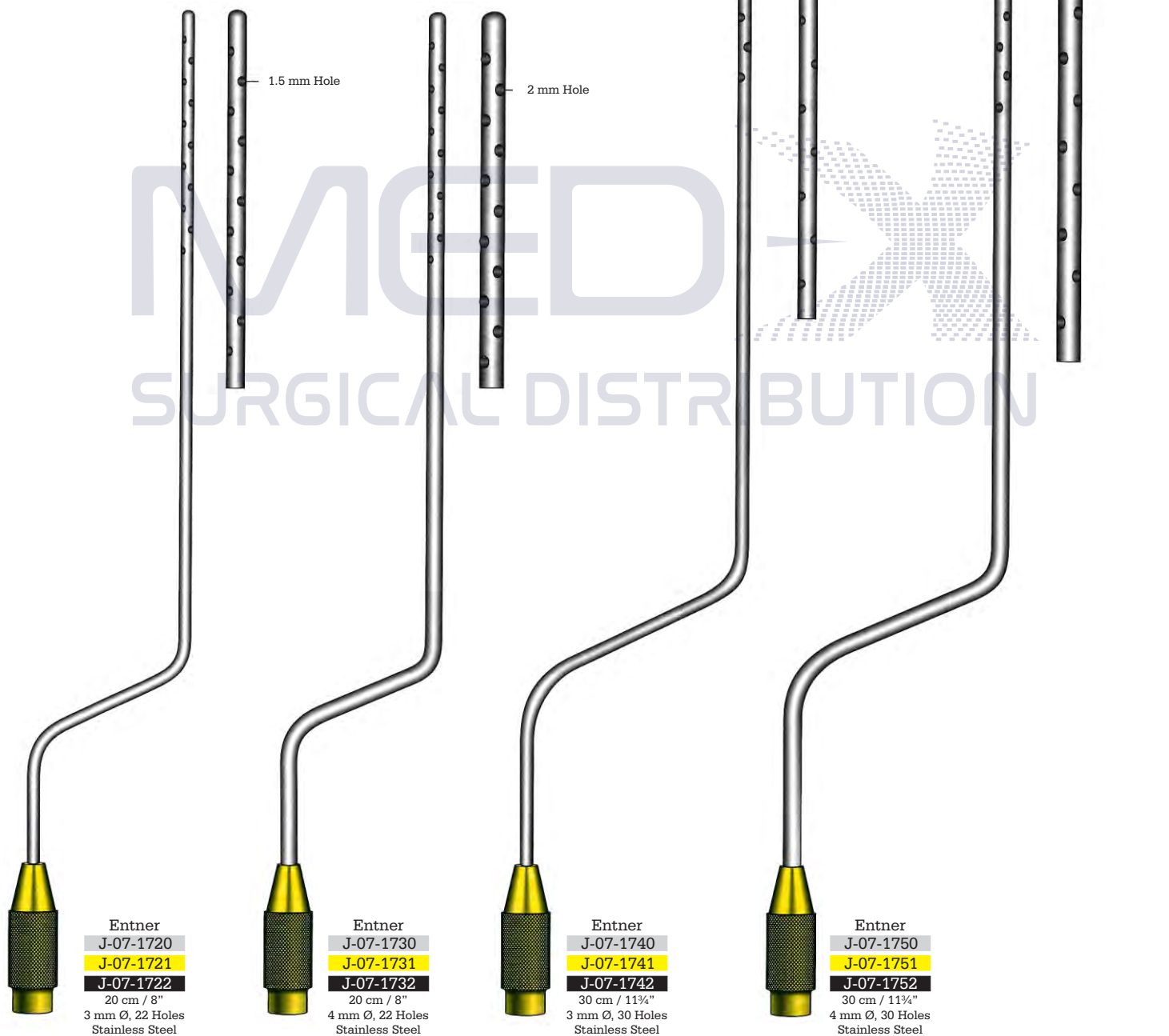



Mercedes
J-07-1760
J-07-1761
J-07-1762
 10 cm / 4"
 1 mm Ø
 3 Slots
 Stainless Steel

Mercedes
J-07-1770
J-07-1771
J-07-1772
 15 cm / 6"
 1.5 mm Ø
 3 Slots
 Stainless Steel

Mercedes
J-07-1780
J-07-1781
J-07-1782
J-07-1785
J-07-1786
J-07-1787
 10 cm / 4"
 10 cm / 4"
 10 cm / 4"
 15 cm / 6"
 1.7 mm Ø
 3 lateral holes
 Stainless Steel

Mercedes
J-07-1790
J-07-1791
J-07-1792
J-07-1795
J-07-1796
J-07-1797
 10 cm / 4"
 10 cm / 4"
 15 cm / 6"
 2 mm Ø
 3 lateral holes
 Stainless Steel

Mercedes
J-07-1800
J-07-1801
J-07-1802
J-07-1805
J-07-1806
J-07-1807
 10 cm / 4"
 10 cm / 4"
 10 cm / 4"
 15 cm / 6"
 2.5 mm Ø
 3 lateral holes
 Stainless Steel

Mercedes
J-07-1810
J-07-1811
J-07-1812
J-07-1815
J-07-1816
J-07-1817
J-07-1820
J-07-1821
J-07-1822
 10 cm / 4"
 10 cm / 4"
 10 cm / 4"
 15 cm / 6"
 15 cm / 6"
 25 cm / 10"
 3 mm Ø
 3 lateral holes
 Stainless Steel

Mercedes
J-07-1830
J-07-1831
J-07-1832
J-07-1835
J-07-1836
J-07-1837
J-07-1840
J-07-1841
J-07-1842
 10 cm / 4"
 10 cm / 4"
 10 cm / 4"
 15 cm / 6"
 15 cm / 6"
 25 cm / 10"
 4 mm Ø
 3 lateral holes
 Stainless Steel

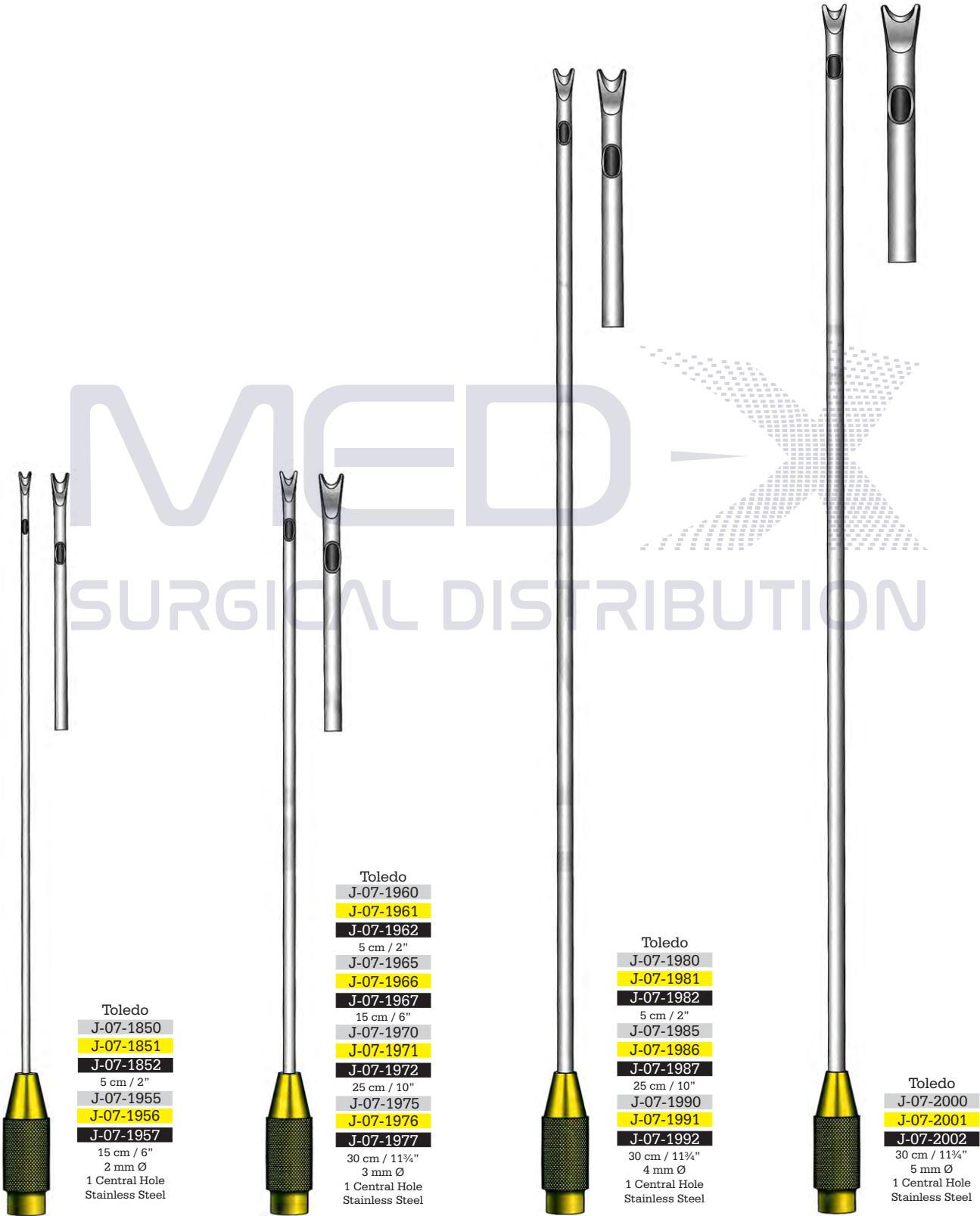

Toledo
J-07-1850
J-07-1851
J-07-1852
 5 cm / 2"
J-07-1955
J-07-1956
J-07-1957
 15 cm / 6"
 2 mm Ø
 1 Central Hole
 Stainless Steel

Toledo
J-07-1960
J-07-1961
J-07-1962
 5 cm / 2"
J-07-1965
J-07-1966
J-07-1967
 15 cm / 6"
J-07-1970
J-07-1971
J-07-1972
 25 cm / 10"
J-07-1975
J-07-1976
J-07-1977
 30 cm / 11¼"
 3 mm Ø
 1 Central Hole
 Stainless Steel

Toledo
J-07-1980
J-07-1981
J-07-1982
 5 cm / 2"
J-07-1985
J-07-1986
J-07-1987
 25 cm / 10"
J-07-1990
J-07-1991
J-07-1992
 30 cm / 11¼"
 4 mm Ø
 1 Central Hole
 Stainless Steel

Toledo
J-07-2000
J-07-2001
J-07-2002
 30 cm / 11¼"
 5 mm Ø
 1 Central Hole
 Stainless Steel

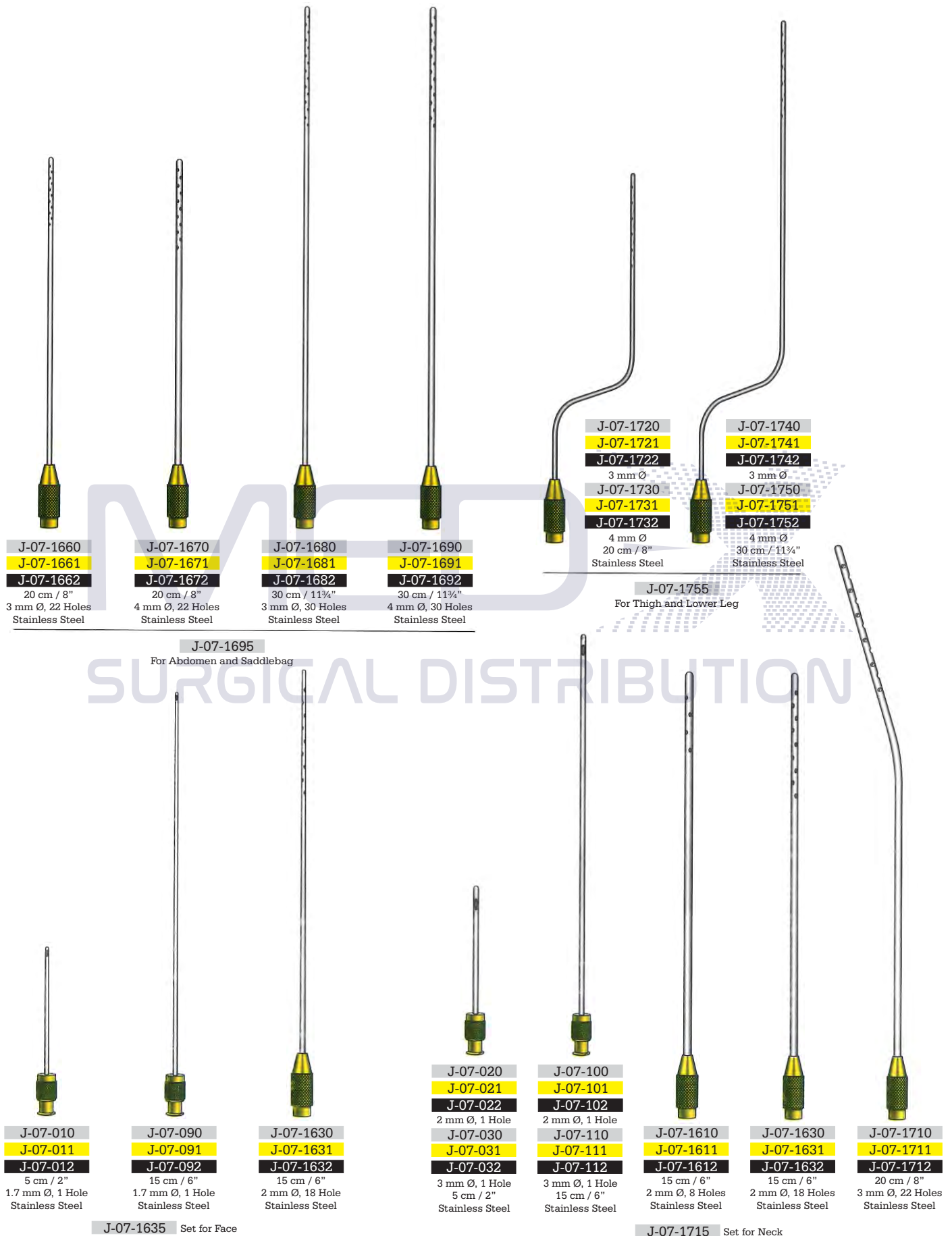

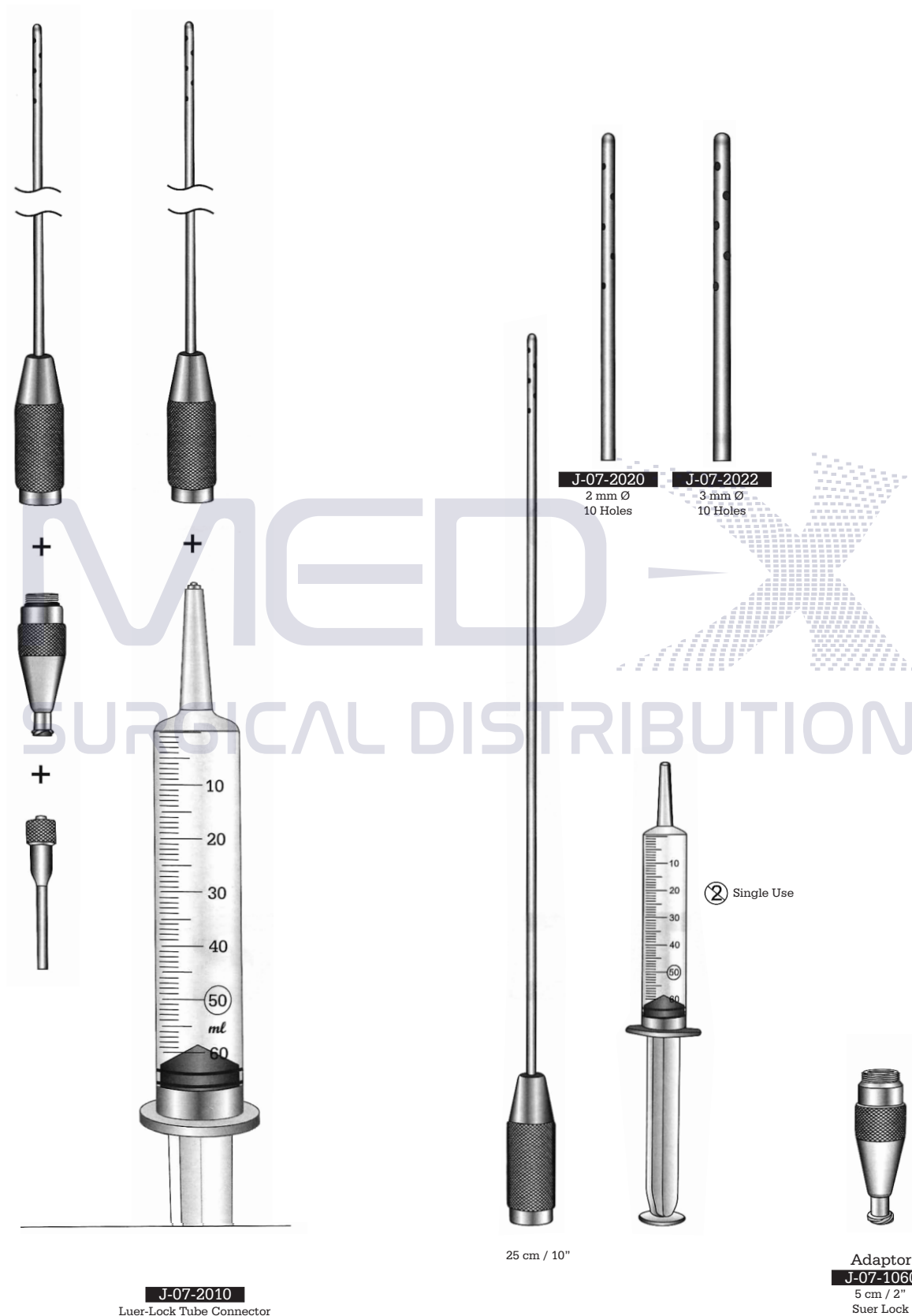

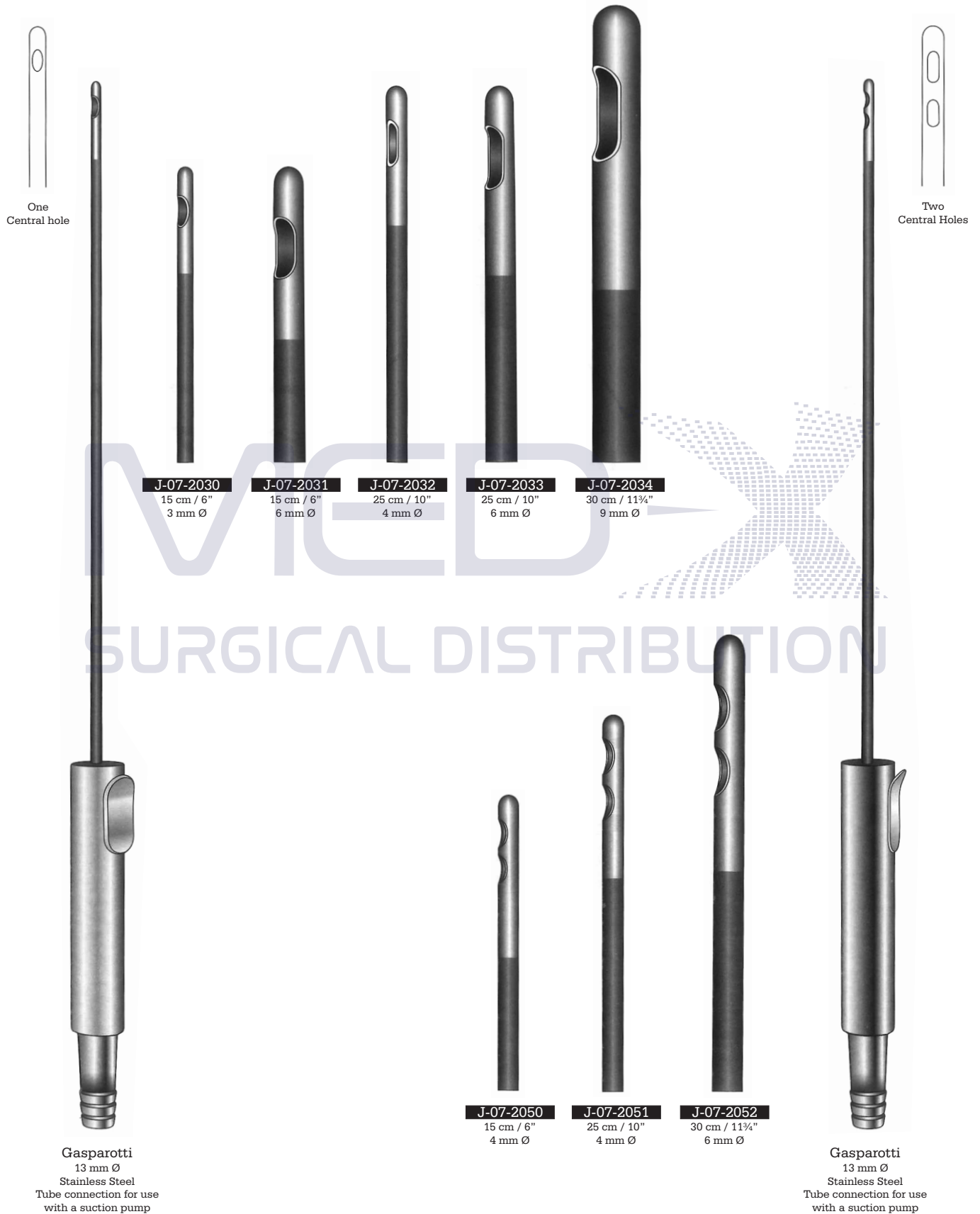



One central hole



Gasparotti
13 mm Ø
Stainless Steel
Tube connection for use
with a suction pump



J-07-2040
15 cm / 6"
3 mm Ø



J-07-2041
15 cm / 6"
6 mm Ø



J-07-2042
25 cm / 10"
6 mm Ø

MEDIX
SURGICAL DISTRIBUTION

ENT & Plastic Surgery Instruments



Scissors

Scissors

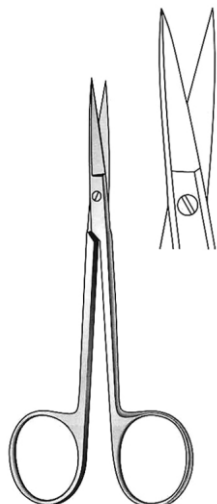

Iris-Fine
J-22-207 9 cm / 3½"
J-22-208 10.5 cm / 4¼"
J-22-211 11.5 cm / 4½"
J-22-2015 12.5 cm / 5"
 Straight
 Standard

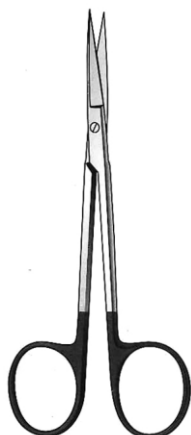

Iris-Fine
J-22-2020 9 cm / 3½"
J-22-208SC 10.5 cm / 4¼"
J-22-2024 11.5 cm / 4½"
J-22-2026 12.5 cm / 5"
 Straight
 One blade serrated
 Super Cut



Iris-Fine
JT-22-1030 9 cm / 3½"
JT-22-1032 10.5 cm / 4¼"
JT-22-693 11.5 cm / 4½"
JT-22-1036 12.5 cm / 5"
 Straight
 TC - Gold



Iris-Fine
JT-22-2040 9 cm / 3½"
JT-22-2042 10.5 cm / 4¼"
JT-22-2044 11.5 cm / 4½"
JT-22-2046 12.5 cm / 5"
 Straight
 One blade Serrated
 Super Cut TC

SURGICAL DISTRIBUTION

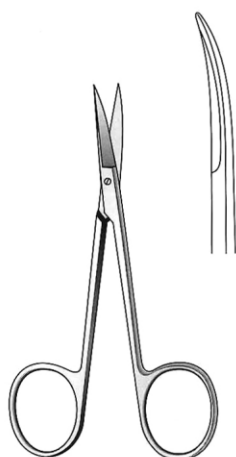

Iris-Fine
J-22-209 9 cm / 3½"
J-22-210 10.5 cm / 4¼"
J-22-212 11.5 cm / 4½"
J-22-2121 12.5 cm / 5"
 Curved
 Standard



Iris-Fine
J-22-2060 9 cm / 3½"
J-22-2100SC 10.5 cm / 4¼"
J-22-212SC 11.5 cm / 4½"
J-22-2066 12.5 cm / 5"
 Curved
 One blade serrated
 Super Cut



Iris-Fine
JT-22-1040 9 cm / 3½"
JT-22-1042 10.5 cm / 4¼"
JT-22-694 11.5 cm / 4½"
JT-22-1046 12.5 cm / 5"
 Curved
 TC-Gold



Iris-Fine
JT-22-2070 9 cm / 3½"
JT-22-2072 10.5 cm / 4¼"
JT-22-2074 11.5 cm / 4½"
JT-22-2076 12.5 cm / 5"
 Curved
 One blade serrated
 Super Cut TC

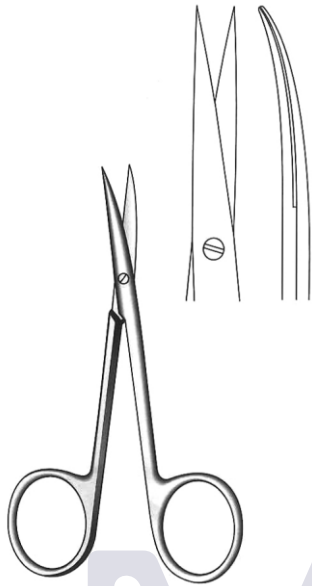

Iris-Kilner
J-22-2081 Straight
J-22-2082 Curved
 11.5 cm / 4½"
 Standard



Iris-Kilner
J-22-2090 Straight
J-22-2092 Curved
 11.5 cm / 4½"
 One Blade Serrated
 Super Cut



Iris-Kilner
JT-22-1050 Straight
JT-22-1052 Curved
 11.5 cm / 4½"
 TC - Gold



Iris-Kilner
JT-22-2105 Straight
JT-22-2102 Curved
 11.5 cm / 4½"
 One Blade Serrated
 Super Cut TC

SURGICAL DISTRIBUTION

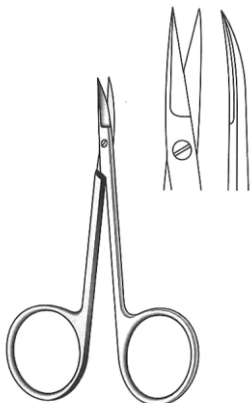

Micro-Iris
J-22-2112 Straight
J-22-2113 Curved
 9 cm / 3½"
 Sharp
 Standard



Micro-Iris
J-22-2124 Straight
J-22-2126 Curved
 9 cm / 3½"
 Sharp
 One Blade Serrated
 Super Cut



Micro-Iris
JT-22-1060 Straight
JT-22-1062 Curved
 9 cm / 3½"
 Sharp
 TC - Gold



Micro-Iris
JT-22-2130 Straight
JT-22-2132 Curved
 9 cm / 3½"
 Sharp
 One Blade Serrated
 Super Cut TC

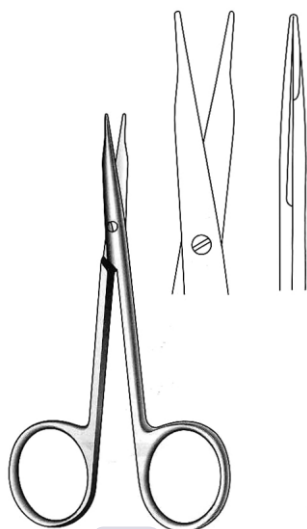

Stevens
J-22-595 10 cm / 4"
J-22-217 11 cm / 4½"
J-22-2140 13 cm / 5½"
J-22-2141 15.5 cm / 6"
 Stright, Blunt
 Standard



Stevens
J-22-595B 10 cm / 4"
J-22-2151 11 cm / 4½"
J-22-2152 13 cm / 5½"
J-22-2153 15.5 cm / 6"
 Stright, Blunt
 One Blade Serrated
 Super Cut



Stevens
JT-22-1070 10 cm / 4"
JT-22-1071 11 cm / 4½"
JT-22-1072 13 cm / 5½"
JT-22-1073 15.5 cm / 6"
 Straight, Blunt
 TC - GOLD



Stevens
JT-22-2160 10 cm / 4"
JT-22-2161 11 cm / 4½"
JT-22-2162 13 cm / 5½"
JT-22-2163 15.5 cm / 6"
 Straight, Blunt
 One Blade Serrated
 Super Cut TC

SURGICAL DISTRIBUTION

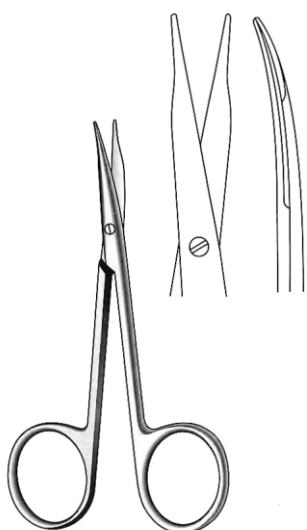

Stevens
J-22-596 10 cm / 4"
J-22-218 11 cm / 4½"
J-22-2166 13 cm / 5½"
J-22-2167 15.5 cm / 6"
 Curved, Blunt
 Standard



Stevens
J-22-2181 10 cm / 4"
J-22-2182 11 cm / 4½"
J-22-2183 13 cm / 5½"
J-22-2184 15.5 cm / 6"
 Curved, Blunt
 One Blade Serrated
 Super Cut

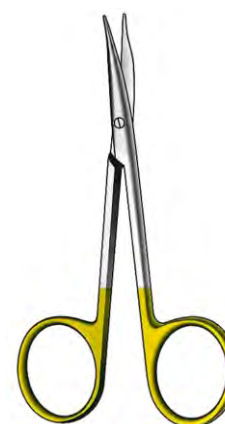

Stevens
JT-22-1080 10 cm / 4"
JT-22-1081 11 cm / 4½"
JT-22-1082 13 cm / 5½"
JT-22-1083 15.5 cm / 6"
 Curved, Blunt
 TC - GOLD



Stevens
JT-22-2290 10 cm / 4"
JT-22-2291 11 cm / 4½"
JT-22-2292 13 cm / 5½"
JT-22-2293 15.5 cm / 6"
 Curved, Blunt
 One Blade Serrated
 Super Cut TC

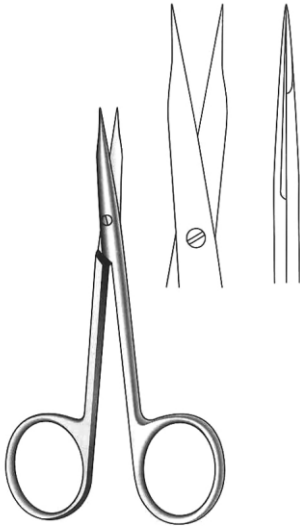

Stevens
J-22-590 10 cm / 4"
J-22-215 11 cm / 4½"
J-22-2300 13 cm / 5¼"
J-22-2301 15.5 cm / 6"
 Straight, Sharp
 Standard



Stevens
J-22-2310 10 cm / 4"
J-22-2311 11 cm / 4½"
J-22-2312 13 cm / 5¼"
J-22-2313 15.5 cm / 6"
 Straight, Sharp
 One Blade Serrated
 Super Cut



Stevens
JT-22-1090 10 cm / 4"
JT-22-1091 11 cm / 4½"
JT-22-1092 13 cm / 5¼"
JT-22-1093 15.5 cm / 6"
 Straight, Sharp
 TC - GOLD



Stevens
JT-22-2320 10 cm / 4"
JT-22-2321 11 cm / 4½"
JT-22-2322 13 cm / 5¼"
JT-22-2323 15.5 cm / 6"
 Straight, Sharp
 One Blade Serrated
 Super Cut TC

SURGICAL DISTRIBUTION

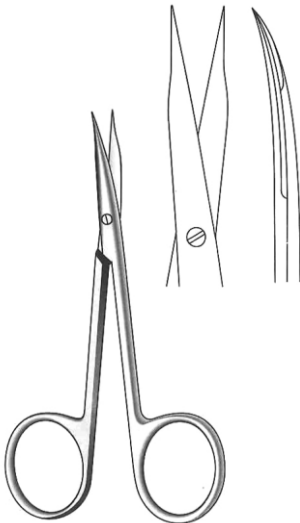

Stevens
J-22-591 10 cm / 4"
J-22-216 11 cm / 4½"
J-22-2329 13 cm / 5¼"
J-22-2331 15.5 cm / 6"
 Curved, Sharp
 Standard



Stevens
J-22-216B 10 cm / 4"
J-22-2342 11 cm / 4½"
J-22-2343 13 cm / 5¼"
J-22-2344 15.5 cm / 6"
 Curved, Sharp
 One Blade Serrated
 Super Cut



Stevens
JT-22-1100 10 cm / 4"
JT-22-1101 11 cm / 4½"
JT-22-1102 13 cm / 5¼"
JT-22-1103 15.5 cm / 6"
 Curved, Sharp
 TC - GOLD



Stevens
JT-22-2350 10 cm / 4"
JT-22-2351 11 cm / 4½"
JT-22-2352 13 cm / 5¼"
JT-22-2353 15.5 cm / 6"
 Curved, Sharp
 One Blade Serrated
 Super Cut TC

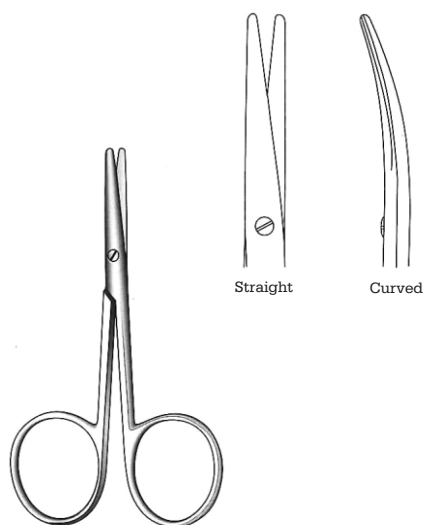

Lexer-Baby
J-22-173 Straight
J-22-174 Curved
 10 cm / 4"



Lexer-Baby
J-22-2360 Straight
J-22-2362 Curved
 10 cm / 4"
 One Blade Serrated
 Super Cut

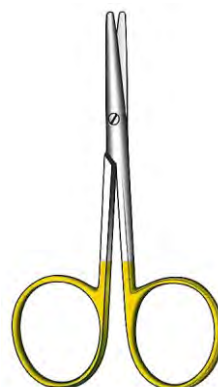

Lexer-Baby
JT-22-173 Straight
JT-22-174 Curved
 10 cm / 4"
 TC - Gold



Lexer-Baby
JT-22-2370 Straight
JT-22-2372 Curved
 10 cm / 4"
 One Blade Serrated
 Super Cut TC

MEDIX
SURGICAL DISTRIBUTION

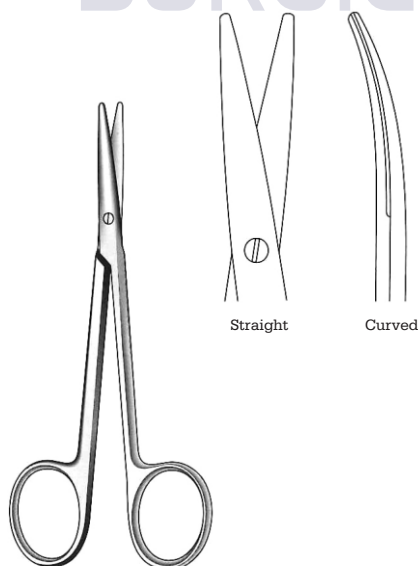

Knapp
J-22-2381 Straight
J-22-2382 Curved
 12.5 cm / 5"
 Standard



Knapp
J-22-2390 Straight
J-22-2392 Curved
 12.5 cm / 5"
 One Blade Serrated
 Super Cut



Knapp
JT-22-1120 Straight
JT-22-1122 Curved
 12.5 cm / 5"
 TC - Gold



Knapp
JT-22-2401 Straight
JT-22-2402 Curved
 12.5 cm / 5"
 One Blade Serrated
 Super Cut TC

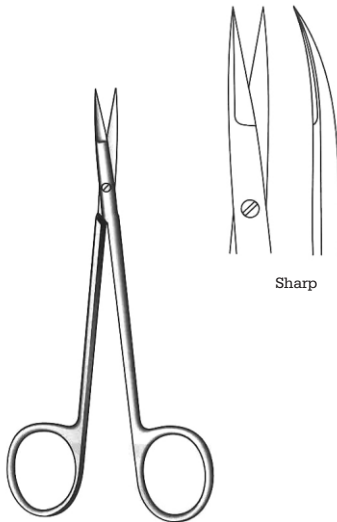

Sharp

Knapp
J-22-2411 Straight
J-22-2412 Curved
 12 cm / 4 3/4"
 Sharp
 Standard



Knapp
J-22-2426 Straight
J-22-2428 Curved
 12 cm / 4 3/4"
 Sharp
 One Blade Serrated
 Super Cut



Knapp
JT-22-1130 Straight
JT-22-1132 Curved
 12 cm / 4 3/4"
 Sharp
 TC - Gold



Knapp
JT-22-2430 Straight
JT-22-2431 Curved
 12 cm / 4 3/4"
 Sharp
 One Blade Serrated
 Super Cut TC

SURGICAL DISTRIBUTION

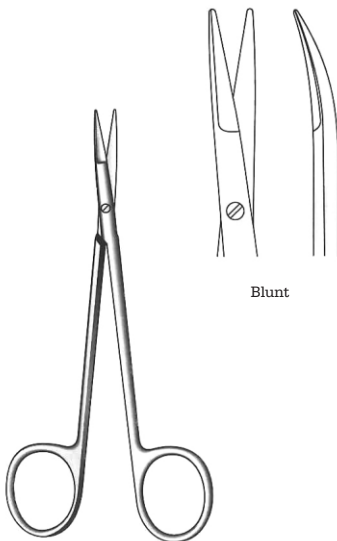

Blunt

Knapp
J-22-2345 Straight
J-22-2346 Curved
 12 cm / 4 3/4"
 Blunt
 Standard



Knapp
J-22-2351 Straight
J-22-2352 Curved
 12 cm / 4 3/4"
 Blunt
 One Blade Serrated
 Super Cut



Knapp
JT-22-1141 Straight
JT-22-1142 Curved
 12 cm / 4 3/4"
 Blunt
 TC - Gold



Knapp
JT-22-2360 Straight
JT-22-2362 Curved
 12 cm / 4 3/4"
 Blunt
 One Blade Serrated
 Super Cut TC

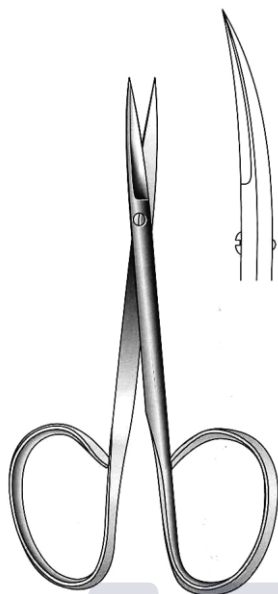

Iris
J-22-350 Straight
J-22-351 Curved
 10 cm / 4"
 Standard pattern, ribbon type

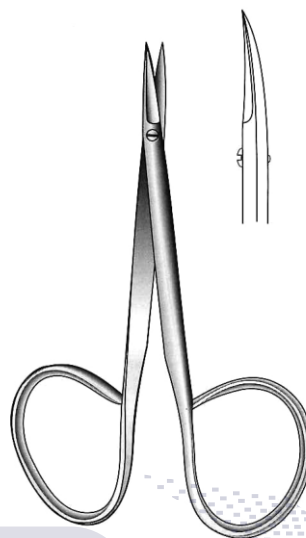

Iris
J-22-355 Straight
J-22-356 Curved
 10 cm / 4"
 with 14 mm blades
 Miniature pattern, ribbon type

SURGICAL DISTRIBUTION

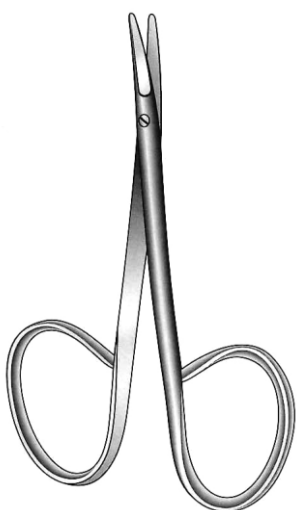

Utility
J-22-360
 10 cm / 4"
 Curved
 Blunt blade 15 mm
 long, ribbon type

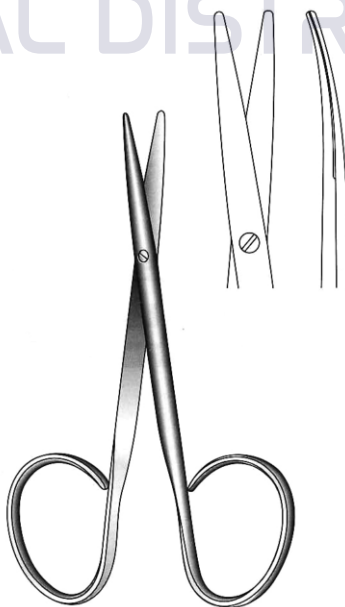

Knapp
J-22-2370
 10 cm / 4"

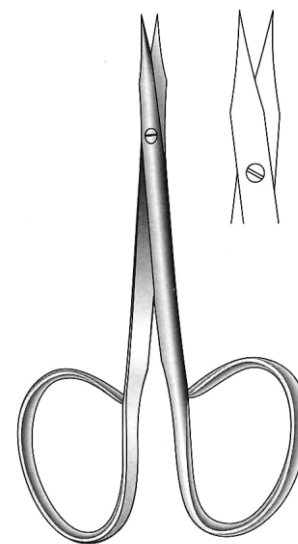

Stevens-Gradle
J-22-375 Sharp/Sharp, straight
J-22-376 Blunt/Blunt, straight
J-22-377 Sharp/Sharp, curved
J-22-378 Blunt/Blunt, curved
 10 cm / 3 3/4"
 Ribbon Tenotomy scissor

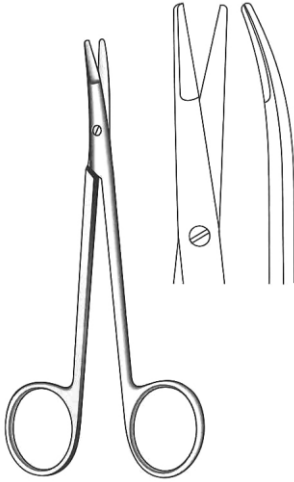

Greenberg PAR
J-22-2380
 11.5 cm / 4½"
 Curved
 Standard

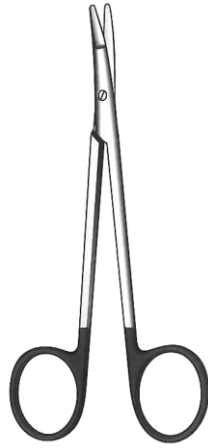

Greenberg PAR
J-22-750
 11.5 cm / 4½"
 Curved
 One Blade Serrated
 Super Cut



Greenberg PAR
JT-22-1140
 11.5 cm / 4½"
 Curved
 TC - Gold



Greenberg PAR
JT-22-2400
 11.5 cm / 4½"
 Curved
 One Blade Serrated
 Super Cut TC

MED 
 SURGICAL DISTRIBUTION

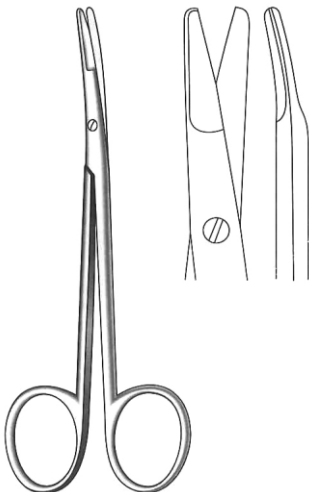

Ragnell (Kilner)
J-22-201 13 cm / 5¼"
J-22-202 15 cm / 6"
J-22-2413 18 cm / 7"
J-22-2414 20 cm / 8"
 Curved
 Standard

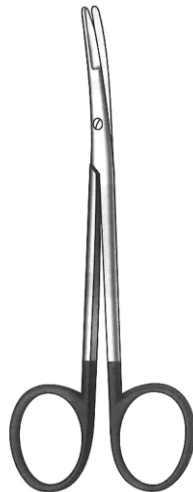

Ragnell (Kilner)
J-22-2420 13 cm / 5¼"
J-22-2421 15 cm / 6"
J-22-2422 18 cm / 7"
J-22-2423 20 cm / 8"
 Curved
 One Blade Serrated
 Super Cut



Ragnell (Kilner)
JT-22-699 12 cm / 4¾"
JT-22-1150 13 cm / 5¼"
JT-22-1152 15 cm / 6"
JT-22-1154 18 cm / 7"
JT-22-1156 20 cm / 8"
 Curved
 TC-Gold



Ragnell (Kilner)
JT-22-2432 13 cm / 5¼"
JT-22-2433 15 cm / 6"
JT-22-2434 18 cm / 7"
JT-22-2436 20 cm / 8"
 Curved
 One Blade Serrated
 Super Cut TC

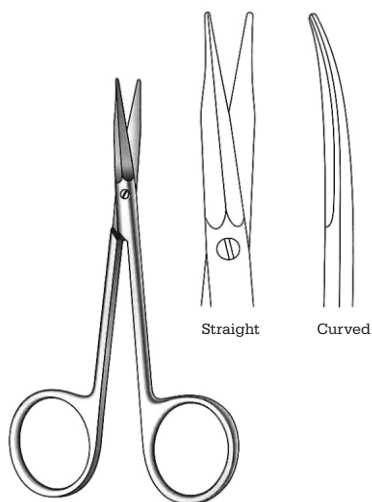

Siegert
J-22-2440 Straight
J-22-2442 Curved
 11.5 cm / 4½"
 Undermining scissors
 Standard

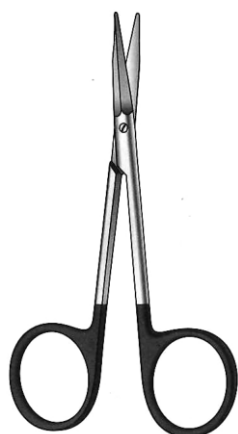

Siegert
J-22-2451 Straight
J-22-730 Curved
 11.5 cm / 4½"
 One Blade Serrated
 Undermining scissors
 Super Cut



Siegert
JT-22-1160 Straight
JT-22-731 Curved
 11.5 cm / 4½"
 Undermining scissors-
 TC - Gold



Siegert
JT-22-2462 Straight
JT-22-732 Curved
 11.5 cm / 4½"
 One Blade Serrated
 Undermining scissors
 Super Cut TC

MEDIX
 SURGICAL DISTRIBUTION

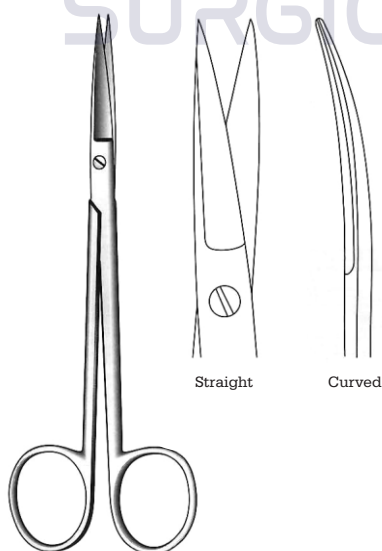

Joseph
J-22-197 Straight
J-22-198 Curved
 14 cm / 5½"
 Standard

J-22-197A
J-22-2474
 15 cm / 6"



Joseph
J-22-2480 Straight
J-22-2482 Curved
 15 cm / 6"
 One Blade Serrated
 Super Cut



Joseph
JT-22-1170 Straight
JT-22-1172 Curved
 15 cm / 6"
 TC - Gold

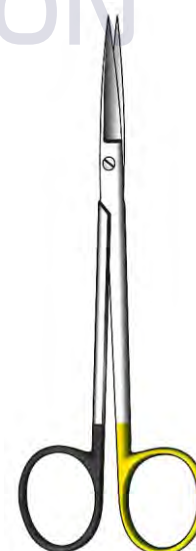

Joseph
JT-22-2490 Straight
JT-22-2492 Curved
 15 cm / 6"
 One Blade Serrated
 Super Cut TC

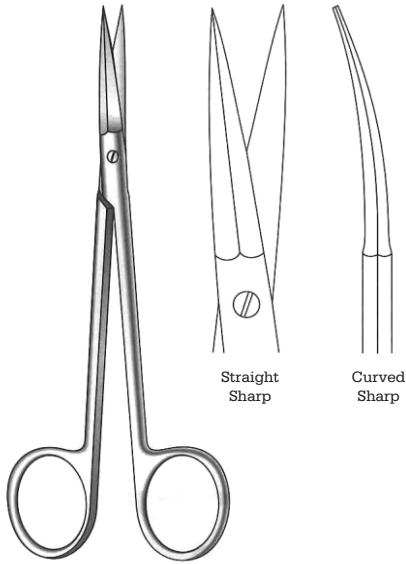

Peck Joseph
J-22-2500 Straight
J-22-733 Curved
 14 cm / 5½"
 Sharp
 Standard

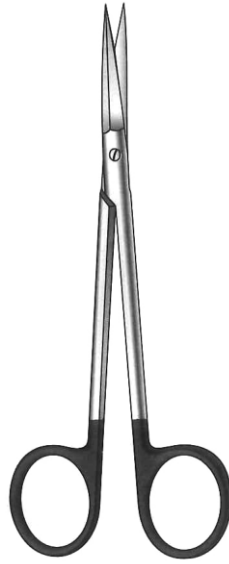

Peck Joseph
J-22-2510 Straight
J-22-734 Curved
 14 cm / 5½"
 Sharp
 One Blade Serrated
 Super Cut



Peck-Joseph
JT-22-1180 Straight
JT-22-1182 Curved
 14 cm / 5½"
 Sharp
 TC - Gold



Peck-Joseph
JT-22-2520 Straight
JT-22-2522 Curved
 14 cm / 5½"
 Sharp
 One Blade Serrated
 Super Cut TC

SURGICAL DISTRIBUTION

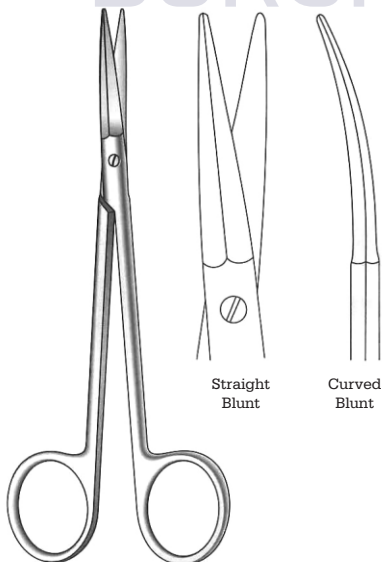

Peck Joseph
J-22-2530 Straight
J-22-2532 Curved
 14 cm / 5½"
 Blunt
 Standard

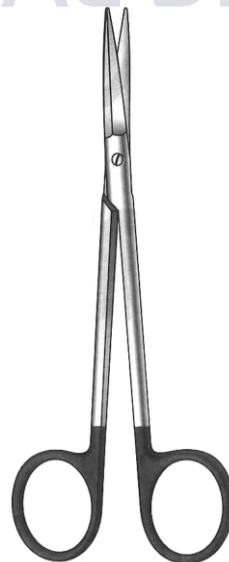

Peck Joseph
J-22-2540 Straight
J-22-2542 Curved
 14 cm / 5½"
 Blunt
 One Blade Serrated
 Super Cut



Peck-Joseph
JT-22-1190 Straight
JT-22-1192 Curved
 14 cm / 5½"
 Blunt
 TC - Gold



Peck-Joseph
JT-22-2550 Straight
JT-22-2552 Curved
 14 cm / 5½"
 Blunt
 One Blade Serrated
 Super Cut TC

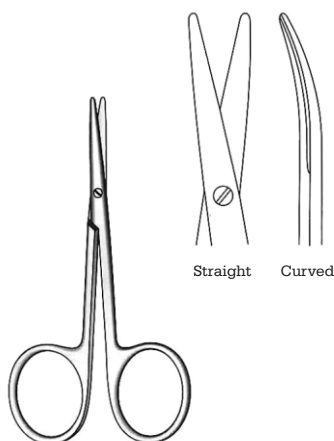

Straight Curved

Mini-Metzenbaum
J-22-2560 Straight
J-22-2562 Curved
9 cm / 3½"
Standard



Mini-Metzenbaum
J-22-2570 Straight
J-22-2572 Curved
9 cm / 3½"
One Blade Serrated
Super Cut

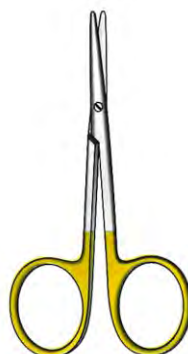

Mini-Metzenbaum
JT-22-1200 Straight
JT-22-1202 Curved
9 cm / 3½"
TC - Gold



Mini-Metzenbaum
JT-22-2580 Straight
JT-22-2582 Curved
9 cm / 3½"
One Blade Serrated
Super Cut TC

MEDIX
SURGICAL DISTRIBUTION

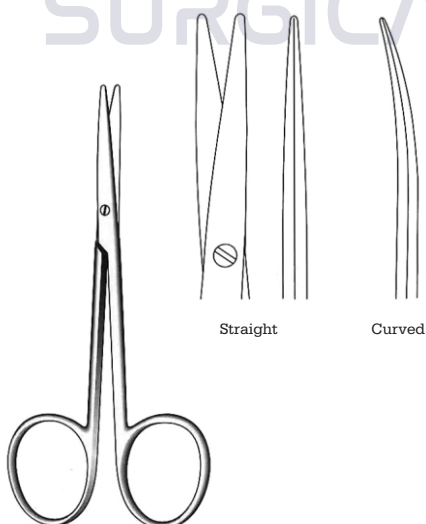

Straight Curved

Baby-Metzenbaum
J-22-056 Straight
J-22-057 Curved
11.5 cm / 4½"
Standard



Baby-Metzenbaum
J-22-2590 Straight
J-22-2592 Curved
11.5 cm / 4½"
One Blade Serrated
Super Cut



Baby-Metzenbaum
JT-22-1210 Straight
JT-22-1212 Curved
11.5 cm / 4½"
TC - Gold



Baby-Metzenbaum
JT-22-2600 Straight
JT-22-2602 Curved
11.5 cm / 4½"
One Blade Serrated
Super Cut TC

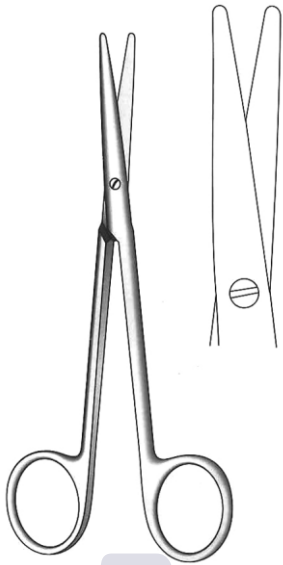

Metzenbaum
J-22-060 14.5 cm / 5 3/4"
J-22-066 18 cm / 7"
J-22-067 20 cm / 8"
 Straight
 Standard

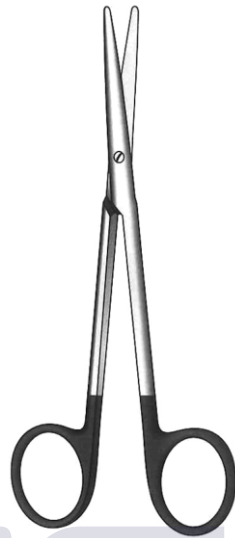

Metzenbaum
J-22-2610 14.5 cm / 5 3/4"
J-22-2612 18 cm / 7"
J-22-2614 20 cm / 8"
 Straight
 One Blade Serrated
 Super Cut



Metzenbaum
JT-22-638 14.5 cm / 5 3/4"
JT-22-639 18 cm / 7"
JT-22-640 20 cm / 8"
 Straight
 TC - Gold



Metzenbaum
JT-22-2620 14.5 cm / 5 3/4"
JT-22-2622 18 cm / 7"
JT-22-2624 20 cm / 8"
 Straight
 One Blade Serrated
 Super Cut TC

SURGICAL DISTRIBUTION

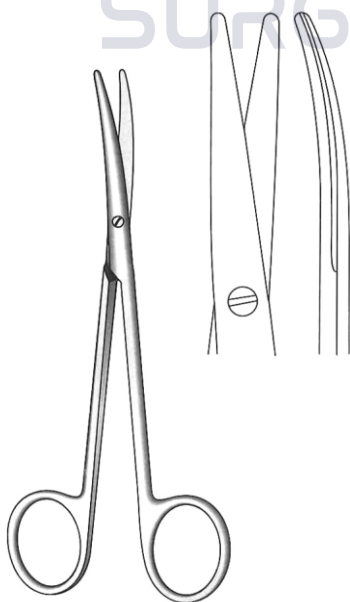

Metzenbaum
J-22-063 14.5 cm / 5 3/4"
J-22-2631 15 cm / 6"
J-22-072 18 cm / 7"
J-22-073 20 cm / 8"
 Curved
 Standard

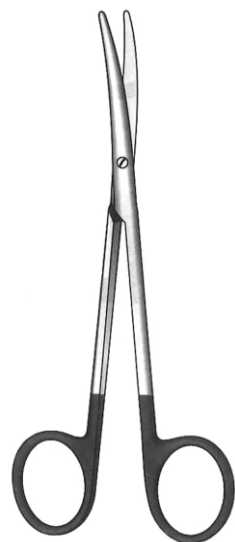

Metzenbaum
J-22-2641 14.5 cm / 5 3/4"
J-22-2642 15 cm / 6"
J-22-2644 18 cm / 7"
J-22-2646 20 cm / 8"
 Curved
 One Blade Serrated
 Super Cut



Metzenbaum
JT-22-645 14.5 cm / 5 3/4"
JT-22-6449 15 cm / 6"
JT-22-646 18 cm / 7"
JT-22-647 20 cm / 8"
 Curved
 TC - Gold



Metzenbaum
JT-22-2651 14.5 cm / 5 3/4"
JT-22-2652 15 cm / 6"
JT-22-2654 18 cm / 7"
JT-22-2656 20 cm / 8"
 Curved
 One Blade Serrated
 Super Cut TC

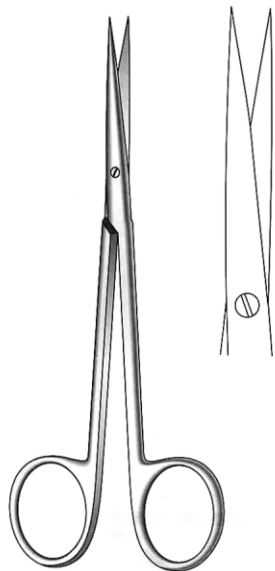

Metzenbaum-Fino
J-22-163 14 cm / 5½"
J-22-164 18 cm / 7"
J-22-165 20 cm / 8"
 Straight
 Standard

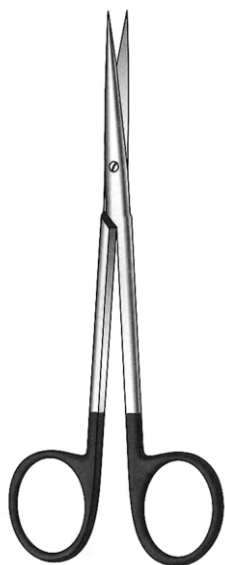

Metzenbaum-Fino
J-22-2660 14 cm / 5½"
J-22-2662 18 cm / 7"
J-22-2664 20 cm / 8"
 Straight
 One Blade Serrated
 Super Cut



Metzenbaum-Fino
JT-22-666 14 cm / 5½"
JT-22-667 16 cm / 6¼"
JT-22-668 18 cm / 7"
JT-22-669 20 cm / 8"
 Straight
 TC-Gold



Metzenbaum-Fino
JT-22-2670 14 cm / 5½"
JT-22-2672 18 cm / 7"
JT-22-2674 20 cm / 8"
 Straight
 One Blade Serrated
 Super Cut TC

SURGICAL DISTRIBUTION

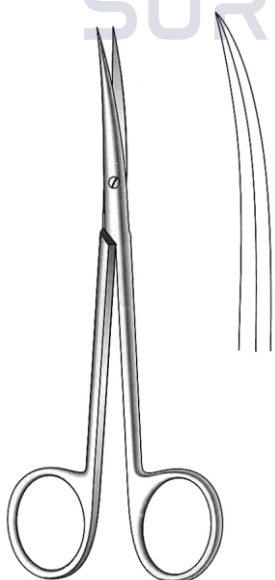

Metzenbaum-Fino
J-22-167 14 cm / 5½"
J-22-168 18 cm / 7"
J-22-169 20 cm / 8"
 Curved
 Standard

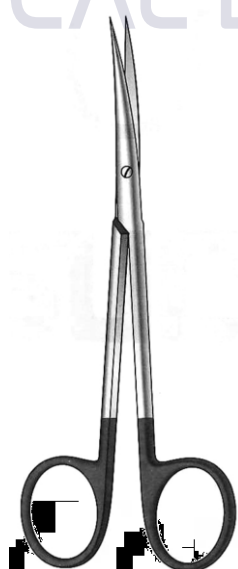

Metzenbaum-Fino
J-22-2680 14 cm / 5½"
J-22-2682 18 cm / 7"
J-22-2684 20 cm / 8"
 Curved
 One Blade Serrated
 Super Cut



Metzenbaum-Fino
JT-22-671 14 cm / 5½"
JT-22-672 16 cm / 6¼"
JT-22-673 18 cm / 7"
JT-22-674 20 cm / 8"
 Straight
 TC-Gold



Metzenbaum-Fino
JT-22-2690 14 cm / 5½"
JT-22-2692 18 cm / 7"
JT-22-2694 20 cm / 8"
 Curved
 One Blade Serrated
 Super Cut TC

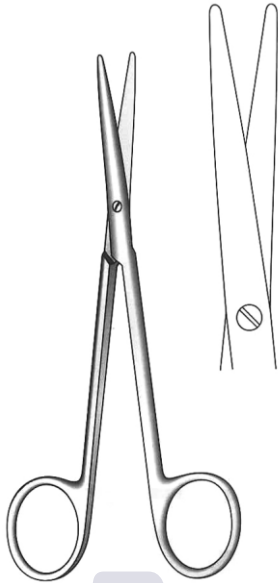

Metzenbaum-Fino
J-22-155 14.5 cm / 5 3/4"
J-22-156 18 cm / 7"
J-22-157 20 cm / 8"
J-22-158 23 cm / 9"
 Straight
 Standard

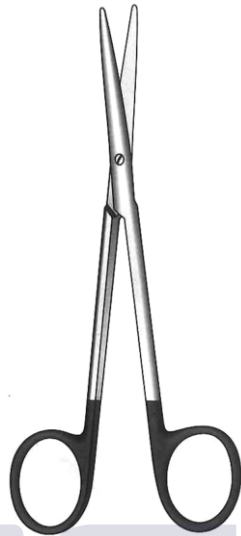

Metzenbaum-Fino
J-22-2740 14.5 cm / 5 3/4"
J-22-2742 18 cm / 7"
J-22-2744 20 cm / 8"
J-22-2746 23 cm / 9"
 Straight
 One Blade Serrated
 Super Cut



Metzenbaum-Fino
JT-22-652 14.5 cm / 5 3/4"
JT-22-653 18 cm / 7"
JT-22-654 20 cm / 8"
JT-22-655 23 cm / 9"
 Straight
 TC-Gold



Metzenbaum-Fino
JT-22-2750 14.5 cm / 5 3/4"
JT-22-2752 18 cm / 7"
JT-22-2754 20 cm / 8"
JT-22-2756 23 cm / 9"
 Straight
 One Blade Serrated
 Super Cut TC

SURGICAL DISTRIBUTION

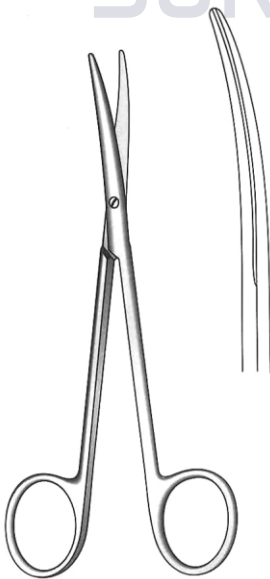

Metzenbaum-Fino
J-22-159 14.5 cm / 5 3/4"
J-22-160 18 cm / 7"
J-22-161 20 cm / 8"
J-22-162 23 cm / 9"
 Curved
 Standard



Metzenbaum-Fino
J-22-2760 14.5 cm / 5 3/4"
J-22-2766 18 cm / 7"
J-22-2767 20 cm / 8"
J-22-2768 23 cm / 9"
 Curved
 One Blade Serrated
 Super Cut



Metzenbaum-Fino
JT-22-659 14.5 cm / 5 3/4"
JT-22-660 18 cm / 7"
JT-22-661 20 cm / 8"
JT-22-662 23 cm / 9"
 Curved
 TC-Gold



Metzenbaum-Fino
JT-22-2770 14.5 cm / 5 3/4"
JT-22-2772 18 cm / 7"
JT-22-2774 20 cm / 8"
JT-22-2776 23 cm / 9"
 Curved
 One Blade Serrated
 Super Cut TC

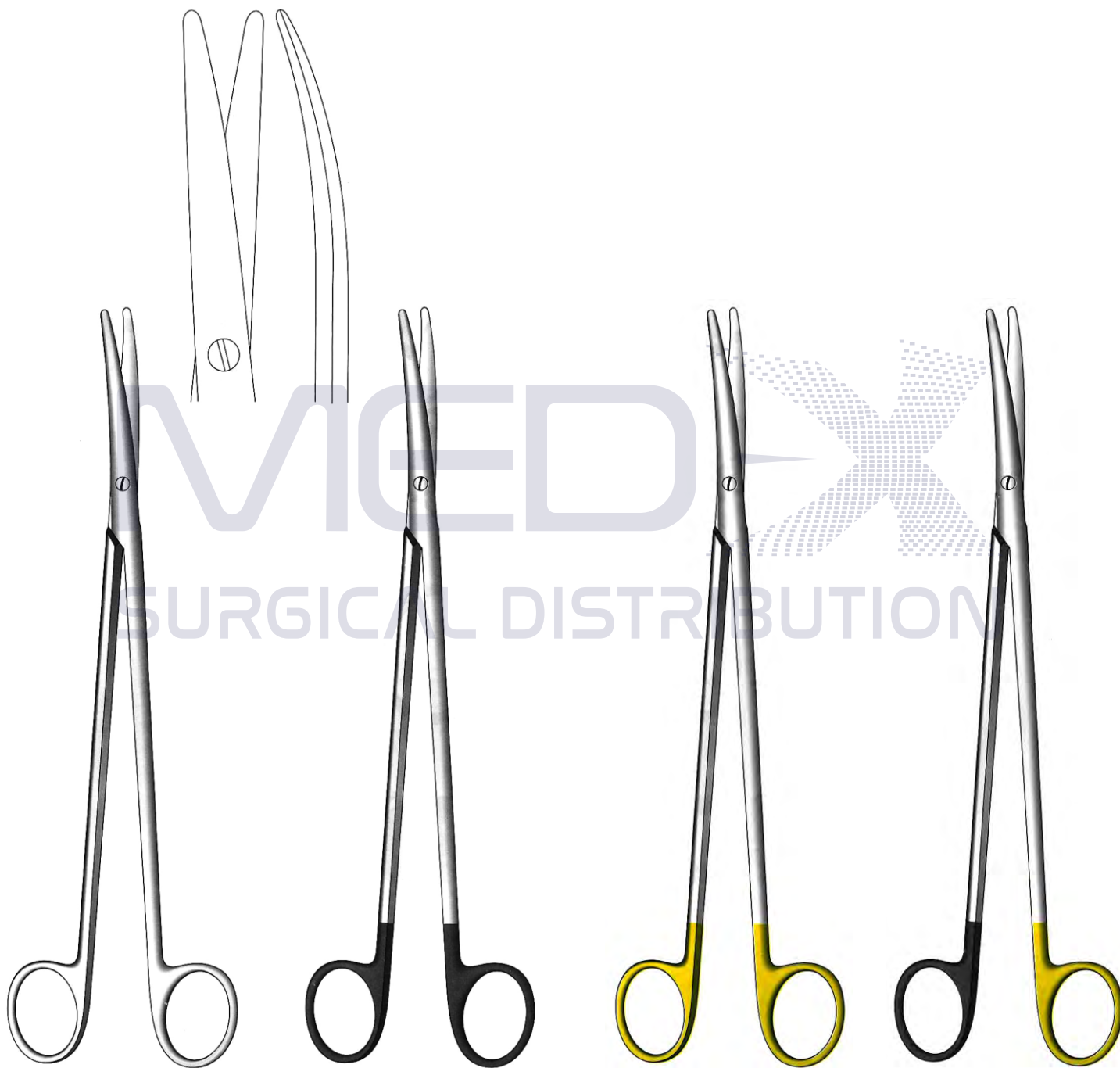

Metzenbaum-Fino

J-22-2780 26 cm / 10¼"
J-22-2782 28.5 cm / 11¼"
Curved
Standard

Metzenbaum-Fino

J-22-2790 26 cm / 10¼"
J-22-2792 28.5 cm / 11¼"
Curved
One Blade Serrated
Super Cut

Metzenbaum-Fino

JT-22-1220 26 cm / 10¼"
JT-22-1222 28.5 cm / 11¼"
Curved
TC - Gold

Metzenbaum-Fino

JT-22-2800 26 cm / 10¼"
JT-22-2802 28.5 cm / 11¼"
Curved
One Blade Serrated
Super Cut TC

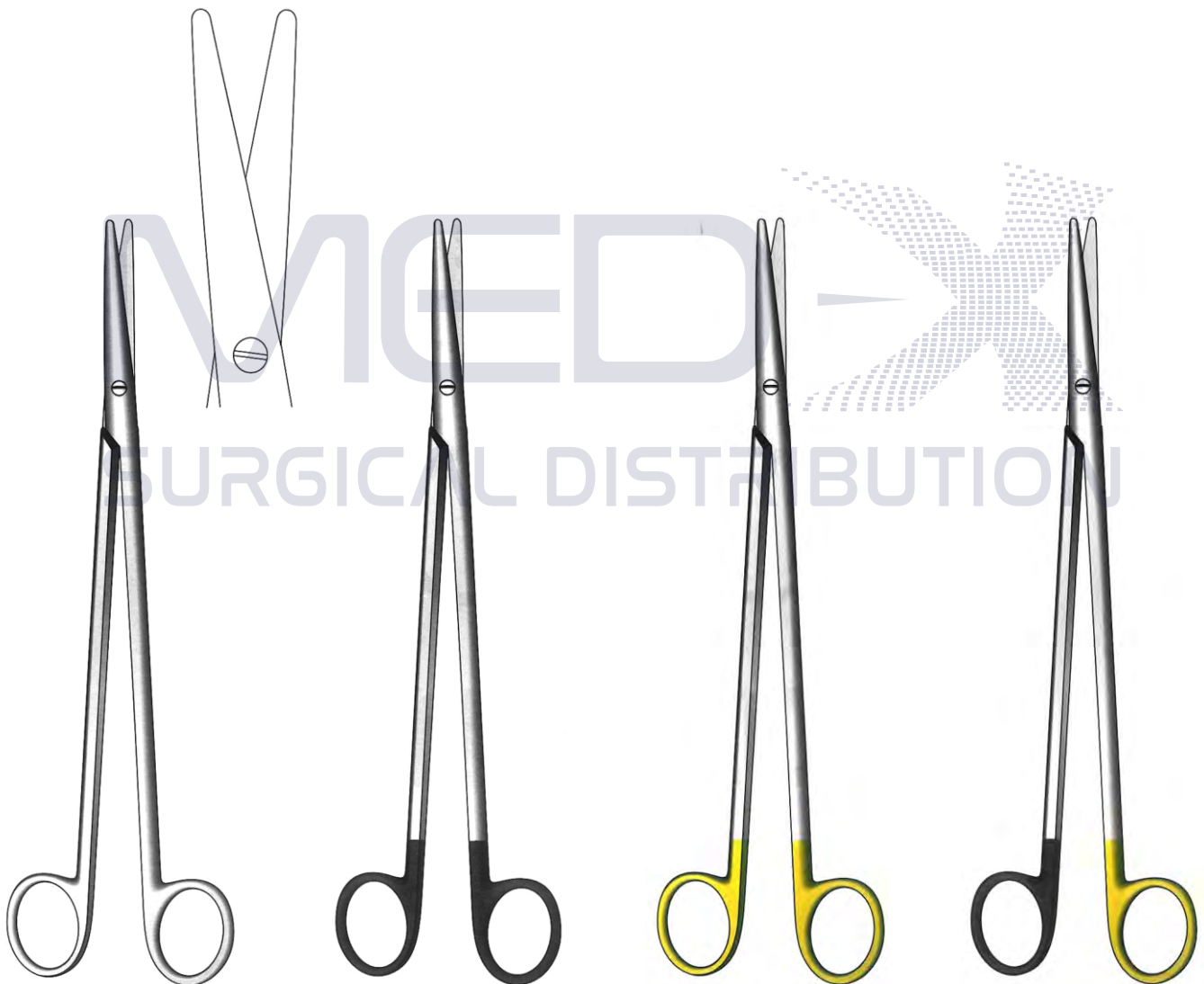

Nelson-Metzenbaum

- J-22-2810** 23 cm / 9"
 - J-22-2812** 26 cm / 10¼"
 - J-22-2814** 30 cm / 11¾"
- Straight
Standard

Nelson-Metzenbaum

- J-22-2820** 23 cm / 9"
 - J-22-2822** 26 cm / 10¼"
 - J-22-2824** 30 cm / 11¾"
- Straight
One Blade Serrated
Super Cut

Nelson-Metzenbaum

- JT-22-1230** 23 cm / 9"
 - JT-22-1232** 26 cm / 10¼"
 - JT-22-1234** 30 cm / 11¾"
- Straight
TC - Gold

Nelson-Metzenbaum

- JT-22-2830** 23 cm / 9"
 - JT-22-2832** 26 cm / 10¼"
 - JT-22-2834** 30 cm / 11¾"
- Straight
One Blade Serrated
Super Cut TC



Nelson-Metzenbaum
J-22-2840 23 cm / 9"
J-22-2842 25 cm / 9¾"
J-22-2844 30 cm / 11¼"
 Curved
 Standard

Nelson-Metzenbaum
J-22-2850 23 cm / 9"
J-22-2852 25 cm / 9¾"
J-22-2854 30 cm / 11¼"
 Curved
 One Blade Serrated
 Super Cut

Nelson-Metzenbaum
JT-22-1240 23 cm / 9"
JT-22-1242 25 cm / 9¾"
JT-22-1244 30 cm / 11¼"
 Curved
 TC - Gold

Nelson-Metzenbaum
JT-22-2860 23 cm / 9"
JT-22-2862 25 cm / 9¾"
JT-22-2864 30 cm / 11¼"
 Curved
 One Blade Serrated
 Super Cut TC

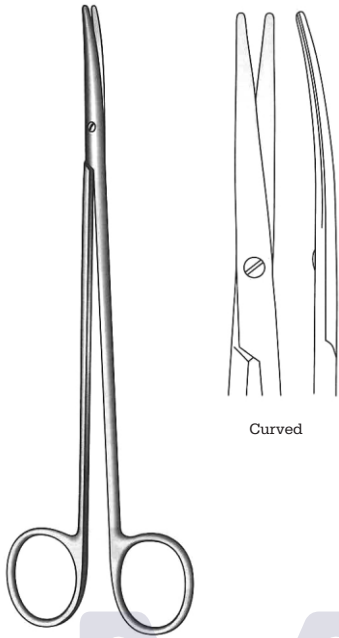

Curved

Toennis-Adson
J-22-182 17.5 cm / 7"
J-22-2870 18 cm / 7"
 Curved
 Standard



Toennis-Adson
J-22-2880
 18 cm / 7"
 Curved
 One Blade Serrated
 Super Cut



Toennis-Adson
JT-22-896
 17 cm / 6 3/4"
 Curved
 TC - Gold



Toennis-Adson
JT-22-2890
 18 cm / 7"
 Curved
 One Blade Serrated
 Super Cut TC

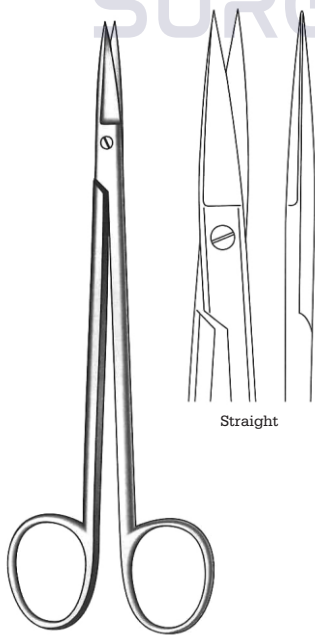

Straight

Kelly
J-22-130 Straight
J-22-132 Curved
 16 cm / 6 1/4"
 Sharp
 Standard

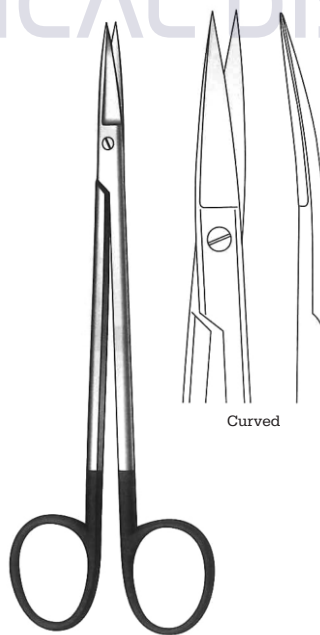

Curved

Kelly
J-22-2900 Straight
J-22-132SC Curved
 16 cm / 6 1/4"
 Sharp
 One Blade Serrated
 Super Cut



Kelly
JT-22-700 Straight
JT-22-701 Curved
 16 cm / 6 1/4"
 Sharp
 TC - Gold



Kelly
JT-22-2910 Straight
JT-22-2912 Curved
 16 cm / 6 1/4"
 Sharp
 One Blade Serrated
 Super Cut TC

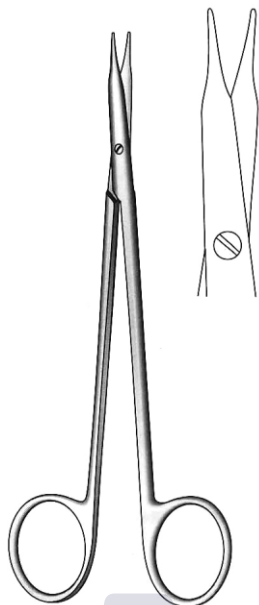

Reynolds (Jameson)

J-22-192	11 cm / 4¼"
J-22-2920	14 cm / 5½"
J-22-194	15 cm / 6"
J-22-2922	16 cm / 6¼"
J-22-575	18 cm / 7"

Straight, Blunt
Standard

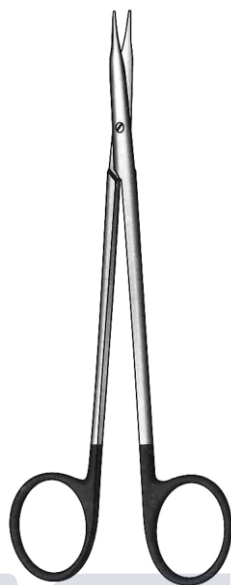

Reynolds (Jameson)

J-22-2930	11 cm / 4¼"
J-22-2932	14 cm / 5½"
J-22-2934	16 cm / 6¼"
J-22-2936	18 cm / 7"

Straight, Blunt
One Blade Serrated
Super Cut



Reynolds (Jameson)

JT-22-1250	11 cm / 4¼"
JT-22-1252	14 cm / 5½"
JT-22-1254	16 cm / 6¼"
JT-22-1256	18 cm / 7"

Straight, Blunt
TC - Gold



Reynolds (Jameson)

JT-22-2940	11 cm / 4¼"
JT-22-2942	14 cm / 5½"
JT-22-2944	16 cm / 6¼"
JT-22-2946	18 cm / 7"

Straight, Blunt
One Blade Serrated
Super Cut TC

SURGICAL DISTRIBUTION

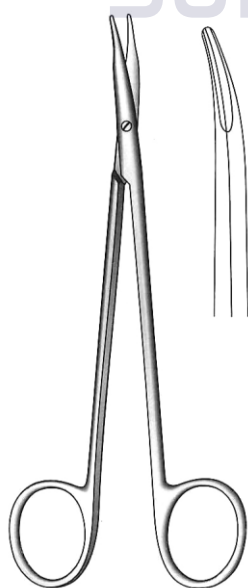

Reynolds (Jameson)

J-22-193	11 cm / 4¼"
J-22-2950	14 cm / 5½"
J-22-195	15 cm / 6"
J-22-2952	16 cm / 6¼"
J-22-196	18 cm / 7"

Curved, Blunt
Standard

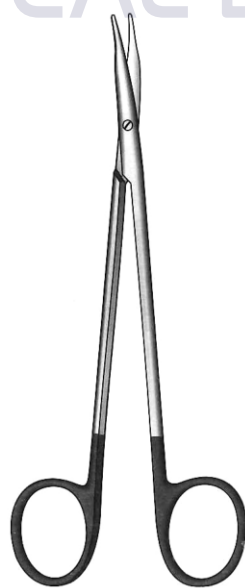

Reynolds (Jameson)

J-22-193B	11 cm / 4¼"
J-22-2962	14 cm / 5½"
J-22-2964	16 cm / 6¼"
J-22-2966	18 cm / 7"

Curved, Blunt
One Blade Serrated
Super Cut



Reynolds (Jameson)

JT-22-1260	11 cm / 4¼"
JT-22-1262	14 cm / 5½"
JT-22-1264	16 cm / 6¼"
JT-22-1266	18 cm / 7"

Curved, Blunt
TC - Gold



Reynolds (Jameson)

JT-22-2970	11 cm / 4¼"
JT-22-2972	14 cm / 5½"
JT-22-2974	16 cm / 6¼"
JT-22-2976	18 cm / 7"

Curved, Blunt
Super Cut TC



SURGICAL DISTRIBUTION



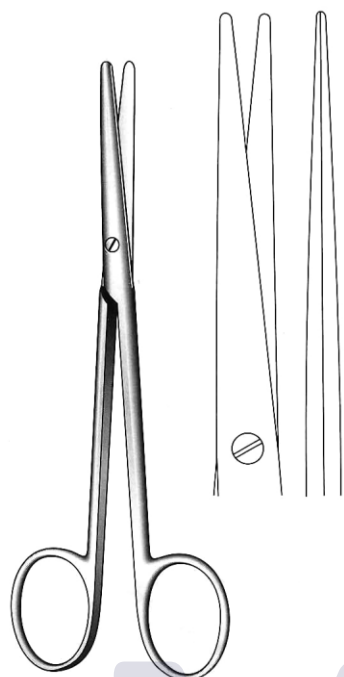

Lexer-Fino
J-22-171
16 cm / 6¼"
Straight
Slender pattern
Standard

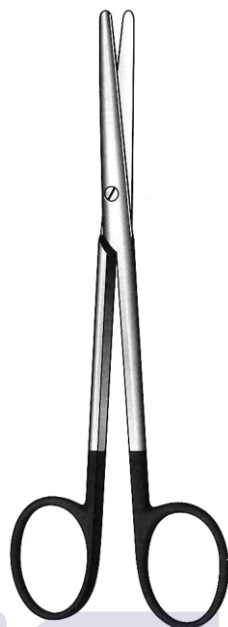

Lexer-Fino
J-22-3040
16 cm / 6¼"
Straight
Slender pattern
One Blade Serrated
Super Cut



Lexer-Fino
JT-22-1280
16 cm / 6¼"
Straight
Slender pattern
TC - Gold



Lexer-Fino
JT-22-3050
16 cm / 6¼"
Straight
Slender pattern
One Blade Serrated
Super Cut TC

SURGICAL DISTRIBUTION

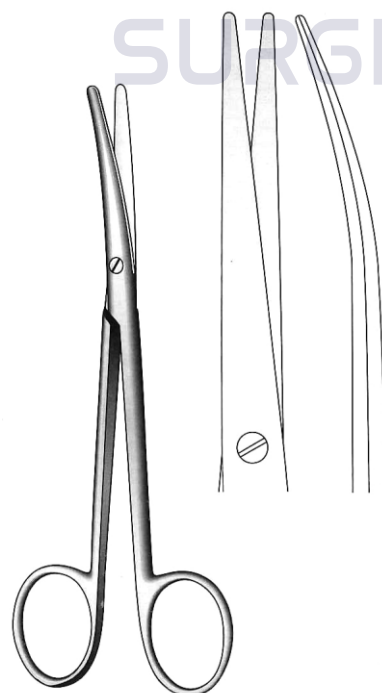

Lexer-Fino
J-22-172
16 cm / 6¼"
Curved
Slender pattern
Standard

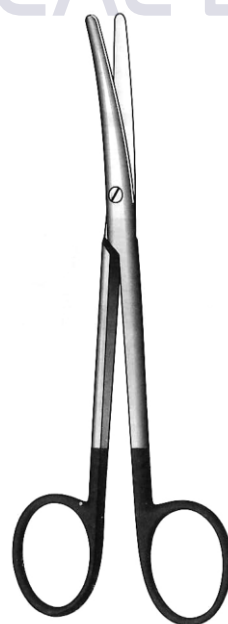

Lexer-Fino
J-22-3060
16 cm / 6¼"
Curved
Slender pattern
One Blade Serrated
Super Cut



Lexer-Fino
JT-22-1290
16 cm / 6¼"
Curved
Slender pattern
TC - Gold



Lexer-Fino
JT-22-3070
16 cm / 6¼"
Curved
Slender pattern
One Blade Serrated
Super Cut TC

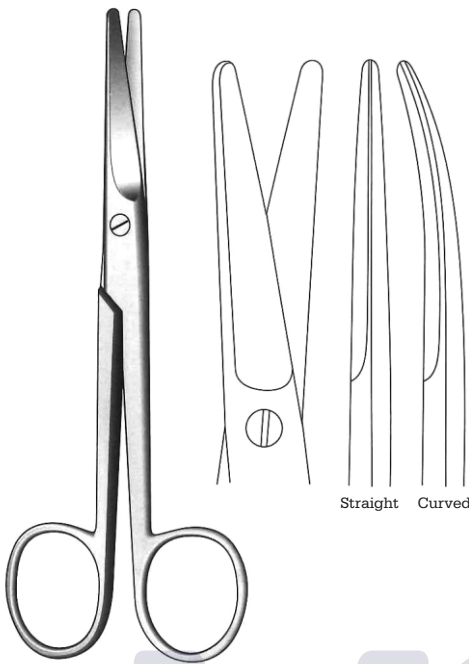

Mayo
J-22-100 14 cm / 5½"
J-22-102 17 cm / 6¾"
 Straight
J-22-104 14 cm / 5½"
J-22-106 17 cm / 6¾"
 Curved
 Standard



Mayo
J-22-3080 14 cm / 5½"
J-22-102SC 17 cm / 6¾"
 Straight
J-22-104A 14 cm / 5½"
J-22-106B 17 cm / 6¾"
 Curved
 One Blade Serrated
 Super Cut



Mayo
JT-22-618 14.5 cm / 5¾"
JT-22-619 17 cm / 6¾"
 Straight
JT-22-621 14.5 cm / 5¾"
JT-22-622 17 cm / 6¾"
 Curved
 TC - Gold



Mayo
JT-22-3100 14 cm / 5½"
JT-22-3104 17 cm / 6¾"
 Straight
JT-22-3110 14 cm / 5½"
JT-22-3114 17 cm / 6¾"
 Curved
 One Blade Serrated
 Super Cut TC

SURGICAL DISTRIBUTION

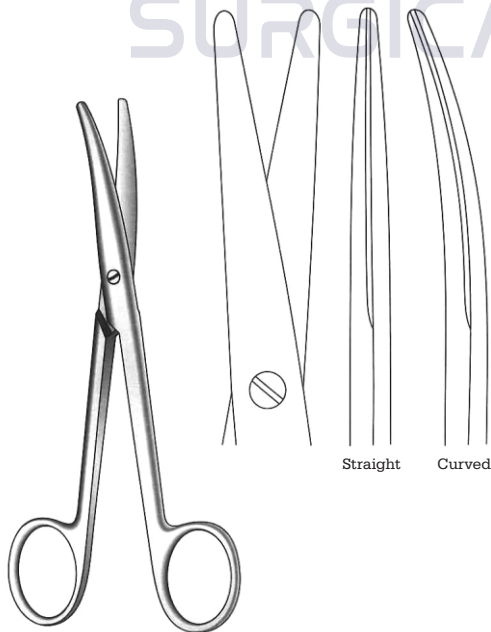

Mayo-Stillie
J-22-111 15 cm / 6"
J-22-113 17 cm / 6¾"
 Straight
J-22-116 15 cm / 6"
J-22-118 17 cm / 6¾"
 Curved
 Standard



Mayo-Stillie
J-22-3120 15 cm / 6"
J-22-3122 17 cm / 6¾"
 Straight
J-22-3130 15 cm / 6"
J-22-3132 17 cm / 6¾"
 Curved
 One Blade Serrated
 Super Cut



Mayo-Stillie
JT-22-624 15 cm / 6"
JT-22-625 17 cm / 6¾"
 Straight
JT-22-626 15 cm / 6"
JT-22-627 17 cm / 6¾"
 Curved
 TC - Gold



Mayo-Stillie
JT-22-3140 15 cm / 6"
JT-22-3142 17 cm / 6¾"
 Straight
JT-22-3150 15 cm / 6"
JT-22-3152 17 cm / 6¾"
 Curved
 One Blade Serrated
 Super Cut TC

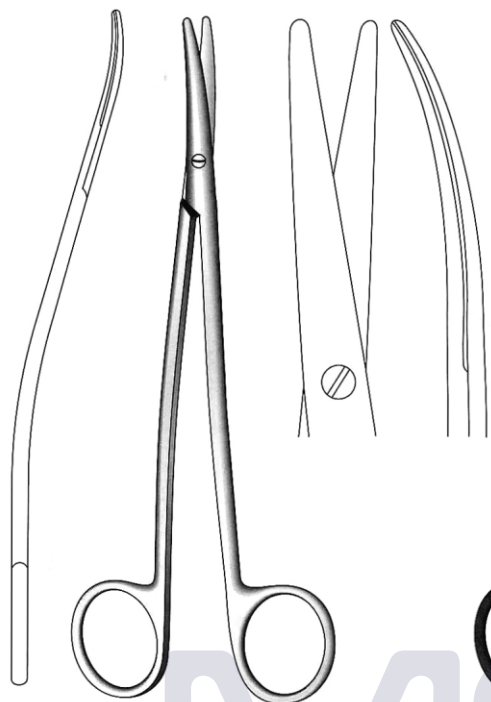

Metzenbaum

J-22-3160 18 cm / 7"
J-22-3162 20 cm / 8"
J-22-3164 23 cm / 9"
Curved
Standard

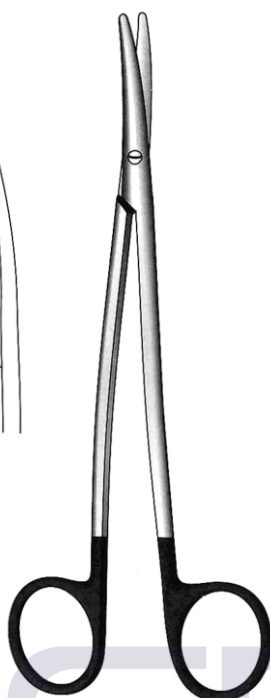

Metzenbaum

J-22-3170 18 cm / 7"
J-22-3172 20 cm / 8"
J-22-3174 23 cm / 9"
Curved
One Blade Serrated
Super Cut



Metzenbaum

JT-22-1300 18 cm / 7"
JT-22-1302 20 cm / 8"
JT-22-1304 23 cm / 9"
Curved
TC - Gold



Metzenbaum

JT-22-3180 18 cm / 7"
JT-22-3182 20 cm / 8"
JT-22-3184 23 cm / 9"
Curved
One Blade Serrated
Super Cut TC

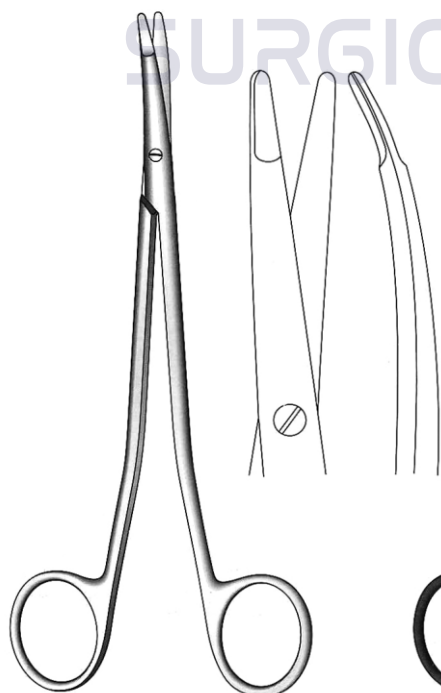

Metzenbaum - Freeman

J-22-3190 18 cm / 7"
J-22-3192 20 cm / 8"
J-22-3194 23 cm / 9"
Curved
Standard

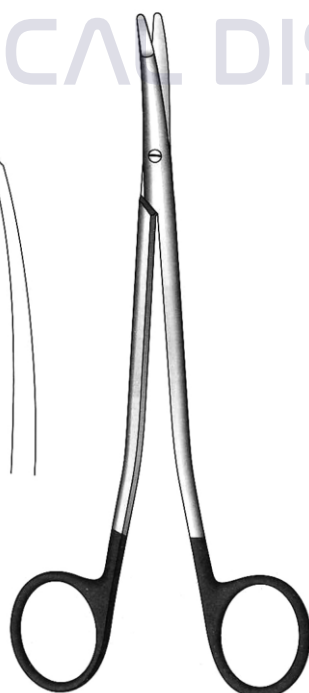

Metzenbaum - Freeman

J-22-3200 18 cm / 7"
J-22-3202 20 cm / 8"
J-22-3204 23 cm / 9"
Curved
One Blade Serrated
Super Cut

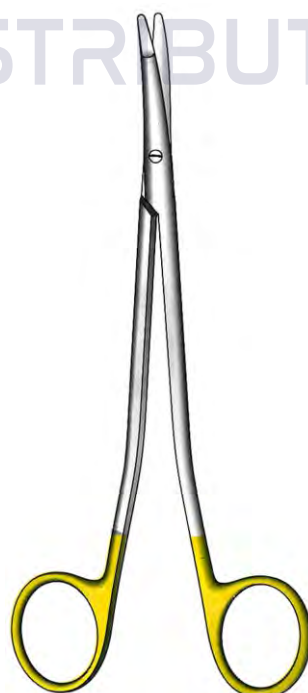

Metzenbaum - Freeman

JT-22-1310 18 cm / 7"
JT-22-1312 20 cm / 8"
JT-22-1314 23 cm / 9"
Curved
TC - Gold

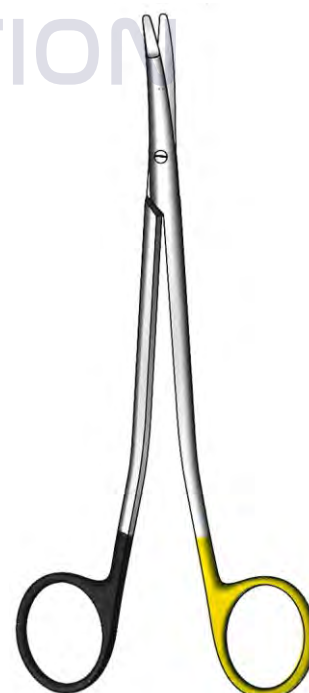

Metzenbaum - Freeman

JT-22-3210 18 cm / 7"
JT-22-3212 20 cm / 8"
JT-22-3214 23 cm / 9"
Curved
One Blade Serrated
Super Cut TC



Fanous

J-22-3220	16.5 cm / 6½"
J-22-3224	20.5 cm / 8"
Straight	
J-22-3230	16.5 cm / 6½"
J-22-3234	20.5 cm / 8"
Curved	

Undermining scissors
Standard

Fanous

J-22-3240	16.5 cm / 6½"
J-22-3244	20.5 cm / 8"
Straight	
J-22-3250	16.5 cm / 6½"
J-22-3254	20.5 cm / 8"
Curved	

Undermining scissors
One Blade Serrated
Super Cut

Fanous

JT-22-1320	16.5 cm / 6½"
JT-22-1324	20.5 cm / 8"
Straight	
JT-22-1322	16.5 cm / 6½"
JT-22-1326	20.5 cm / 8"
Curved	

Undermining scissors
TC - Gold

Fanous

JT-22-3260	16.5 cm / 6½"
JT-22-3264	20.5 cm / 8"
Straight	
JT-22-3270	16.5 cm / 6½"
JT-22-3274	20.5 cm / 8"
Curved	

Undermining scissors
One Blade Serrated
Super Cut TC



Kaye

J-22-3280	Curved
J-22-3281	Straight
11.5 cm / 4½"	

Curved, Blepharoplasty scissors
Standard

Kaye

J-22-3290	11.5 cm / 4½"
------------------	---------------

Curved, Blepharoplasty scissors
One Blade Serrated
Super Cut

Kaye

JT-22-1330	11.5 cm / 4½"
-------------------	---------------

Curved, Blepharoplasty scissors
TC - Gold

Kaye

JT-22-3300	11.5 cm / 4½"
-------------------	---------------

Curved, Blepharoplasty scissors
One Blade Serrated
Super Cut TC

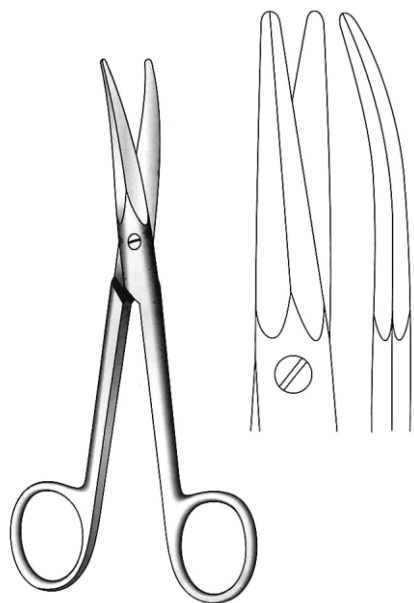

Kaye
J-22-3310 15 cm / 6"
J-22-3312 17 cm / 6 1/4"
 Curved
 Standard

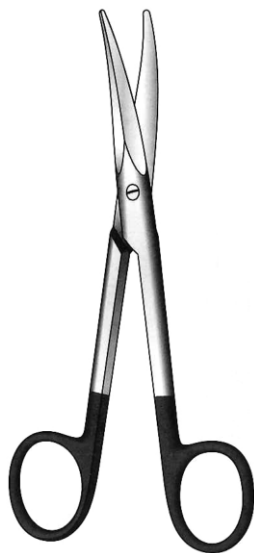

Kaye
J-22-3321 15 cm / 6"
J-22-3322 17 cm / 6 1/4"
 Curved
 One Blade Serrated
 Super Cut



Kaye
JT-22-1340 15 cm / 6"
JT-22-1342 17 cm / 6 1/4"
 Curved
 TC - Gold



Kaye
JT-22-3230 15 cm / 6"
JT-22-3232 17 cm / 6 1/4"
 Curved
 One Blade Serrated
 Super Cut TC

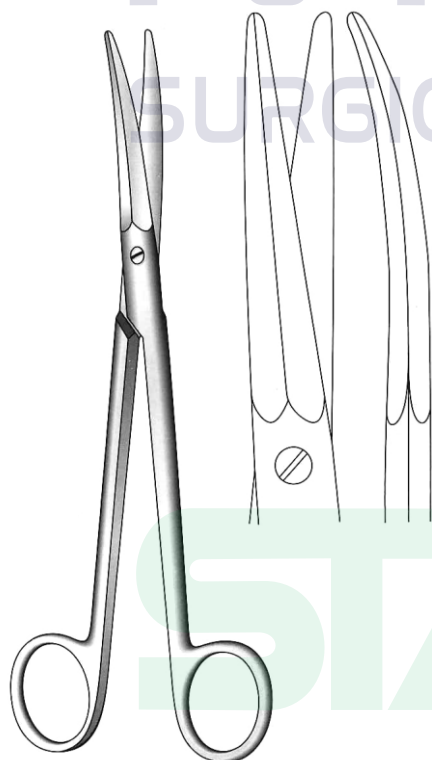

Kaye
J-22-3241 19 cm / 7 1/2"
J-22-3242 23 cm / 9"
 Curved
 Standard

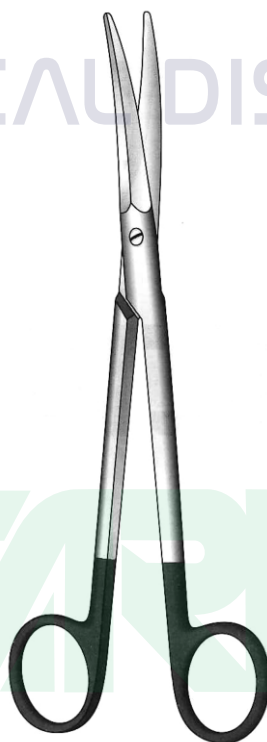

Kaye
J-22-3251 19 cm / 7 1/2"
J-22-3252 23 cm / 9"
 Curved
 One Blade Serrated
 Super Cut



Kaye
JT-22-1350 19 cm / 7 1/2"
JT-22-1352 23 cm / 9"
 Curved
 TC - Gold

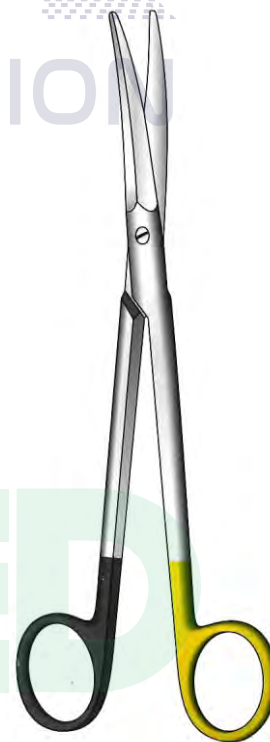

Kaye
JT-22-3261 19 cm / 7 1/2"
JT-22-3262 23 cm / 9"
 Curved
 One Blade Serrated
 Super Cut TC



Gorney
J-22-3270 17 cm / 6¼"
J-22-3272 19 cm / 7½"
J-22-3274 23 cm / 9"
 Curved, Flat Tips
 Standard

Gorney
J-22-3282 17 cm / 6¼"
J-22-3284 19 cm / 7½"
J-22-3286 23 cm / 9"
 Curved, Flat Tips
 One Blade Serrated
 Super Cut

Gorney
JT-22-1360 17 cm / 6¼"
JT-22-1362 19 cm / 7½"
JT-22-1364 23 cm / 9"
 Curved, Flat Tips
 TC - Gold

Gorney
JT-22-3290 17 cm / 6¼"
JT-22-3292 19 cm / 7½"
JT-22-3294 23 cm / 9"
 Curved, Flat Tips
 One Blade Serrated
 Super Cut TC



Gorney-Freeman
J-22-3300
23 cm / 9"
Curved, Facelift Scissors
Standard

Gorney-Freeman
J-22-3320
23 cm / 9"
Curved, Facelift Scissors
One Blade Serrated
Super Cut

Gorney-Freeman
JT-22-1370
23 cm / 9"
Curved, Facelift Scissors
TC - Gold

Gorney-Freeman
JT-22-3320
23 cm / 9"
Curved, Facelift Scissors
One Blade Serrated
Super Cut TC

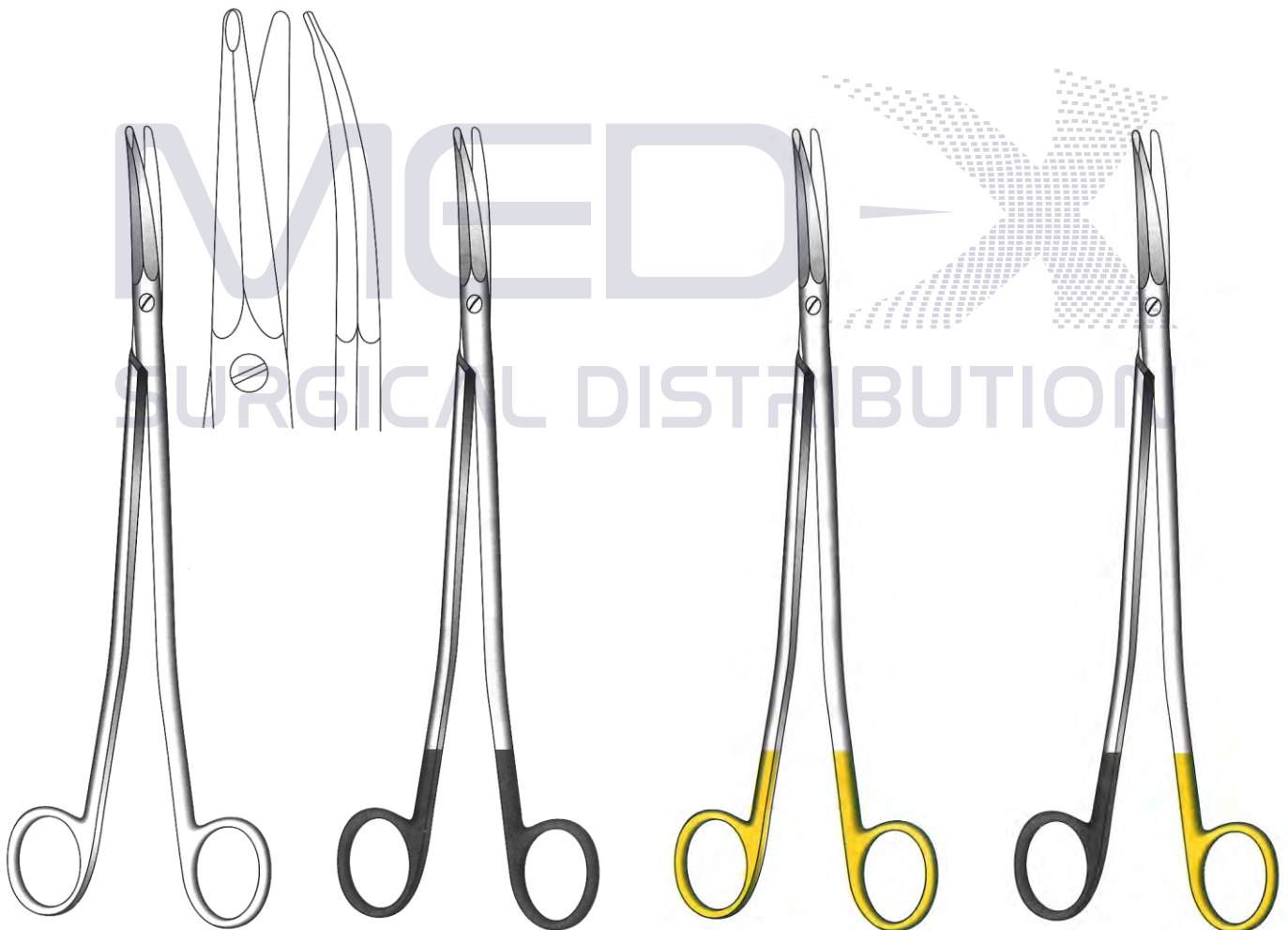

Gorney-Freeman

- J-22-3330** 17 cm / 6¾"
 - J-22-3332** 19 cm / 7½"
 - J-22-3334** 23 cm / 9"
- Curved
Standard

Gorney-Freeman

- J-22-3340** 17 cm / 6¾"
 - J-22-3342** 19 cm / 7½"
 - J-22-3344** 23 cm / 9"
- Curved
One Blade Serrated
Super Cut

Gorney-Freeman

- JT-22-1380** 17 cm / 6¾"
 - JT-22-1382** 19 cm / 7½"
 - JT-22-1384** 23 cm / 9"
- Curved
TC - Gold

Gorney-Freeman

- JT-22-3350** 17 cm / 6¾"
 - JT-22-3352** 19 cm / 7½"
 - JT-22-3354** 23 cm / 9"
- Curved
One Blade Serrated
Super Cut TC

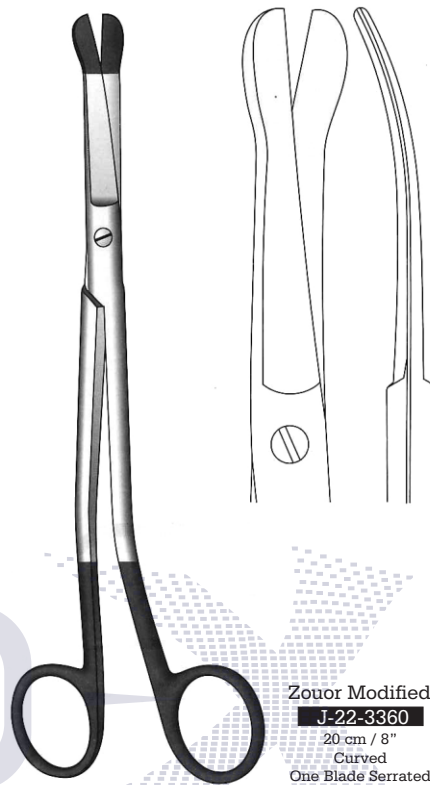
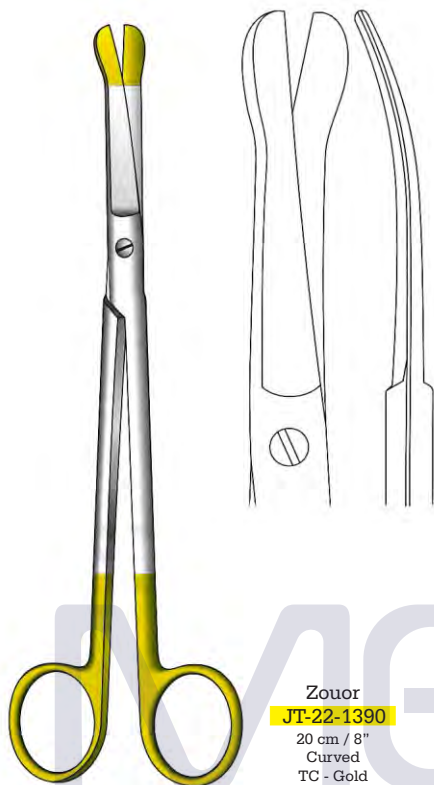

SURGICAL DISTRIBUTION

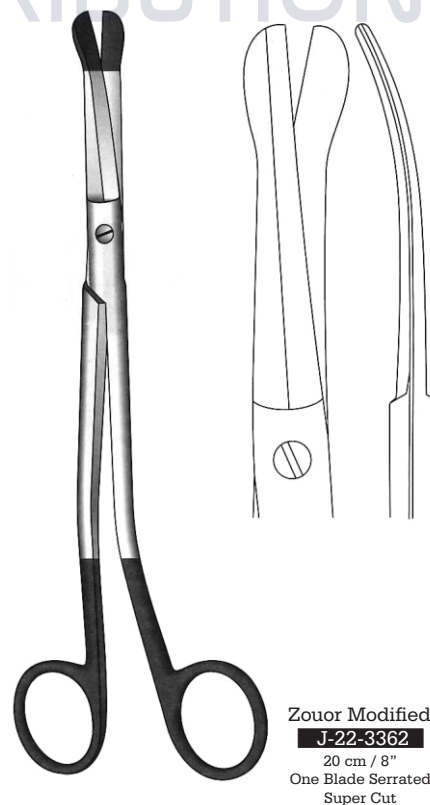
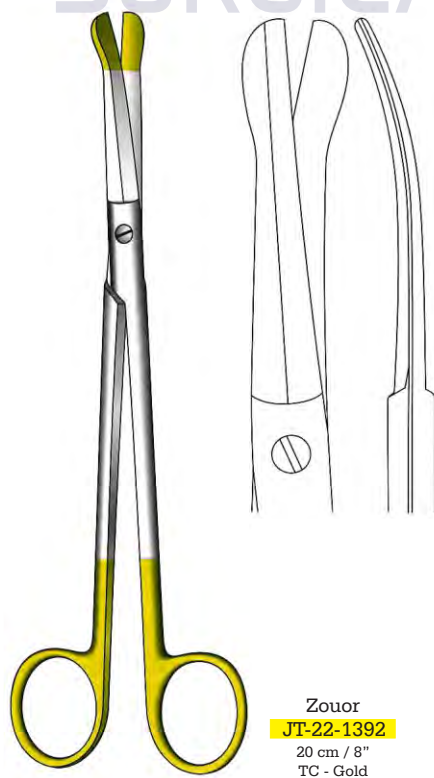

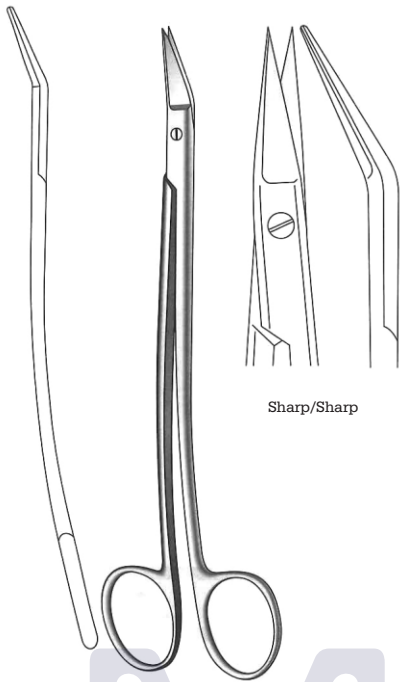

Sharp/Sharp

Dean
J-22-3370 12 cm / 4 3/4"
J-22-186 17 cm / 6 3/4"
 Sharp/Sharp
 Standard

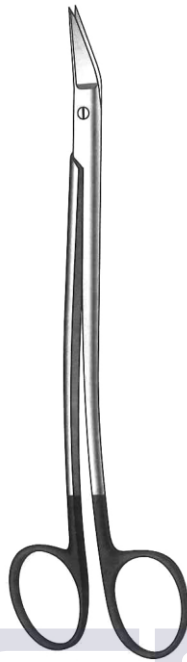

Dean
J-22-3380 12 cm / 4 3/4"
J-22-3384 17 cm / 6 3/4"
 Sharp/Sharp
 One Blade Serrated
 Super Cut



Dean
JT-22-1400 12 cm / 4 3/4"
JT-22-702 17 cm / 6 3/4"
 Sharp/Sharp
 TC - Gold



Dean
JT-22-3390 12 cm / 4 3/4"
JT-22-3394 17 cm / 6 3/4"
 Sharp/Sharp
 One Blade Serrated
 Super Cut TC

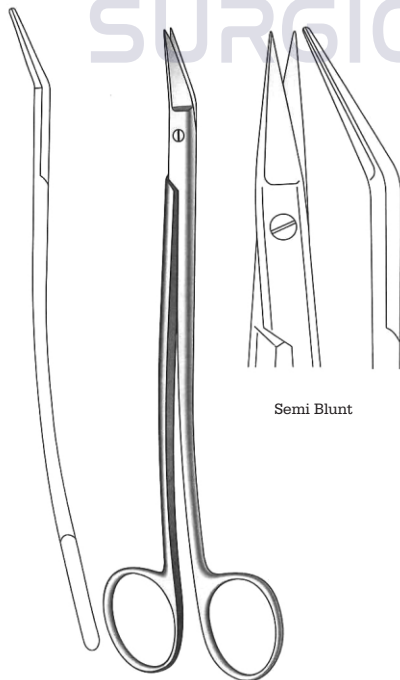

Semi Blunt

Dean
J-22-3400 12 cm / 4 3/4"
J-22-3404 17 cm / 6 3/4"
 Semi Blunt/Blunt
 Standard

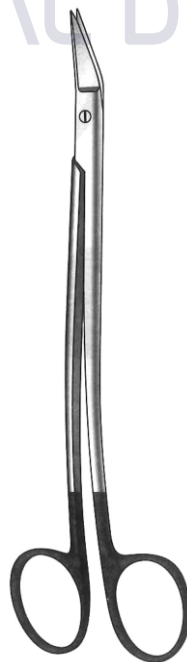

Dean
J-22-3411 12 cm / 4 3/4"
J-22-3414 17 cm / 6 3/4"
 Semi Blunt/Blunt
 One Blade Serrated
 Super Cut



Dean
JT-22-1410 12 cm / 4 3/4"
JT-22-1415 17 cm / 6 3/4"
 Semi Blunt/Blunt
 TC - Gold



Dean
JT-22-3420 12 cm / 4 3/4"
JT-22-3424 17 cm / 6 3/4"
 Semi Blunt/Blunt
 One Blade Serrated
 Super Cut TC

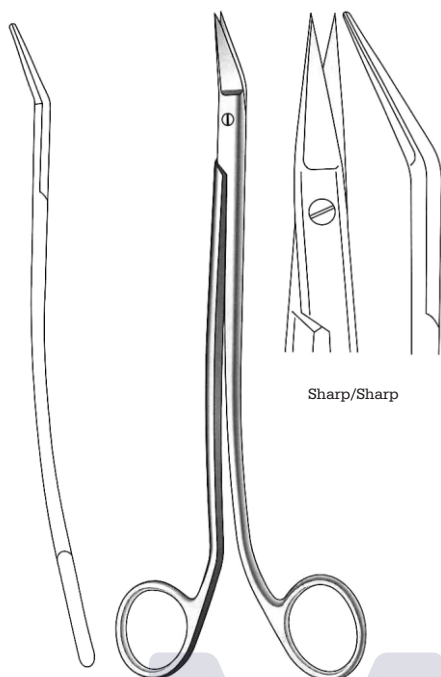

Sharp/Sharp

Dean

J-22-3432 12 cm / 4 3/4"

J-22-3436 17 cm / 6 3/4"

Sharp/Sharp
Standard

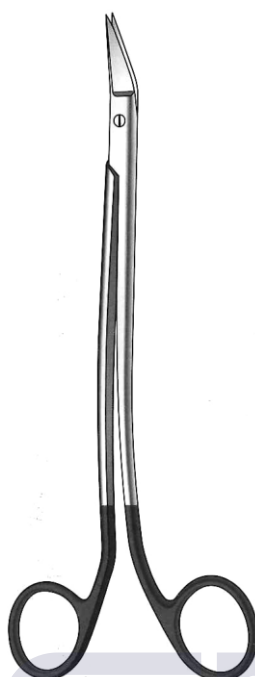

Dean

J-22-3440 12 cm / 4 3/4"

J-22-3444 17 cm / 6 3/4"

Sharp/Sharp
One Blade Serrated
Super Cut



Dean

JT-22-1420 12 cm / 4 3/4"

JT-22-1424 17 cm / 6 3/4"

Sharp/Sharp
Super Cut



Dean

JT-22-3450 12 cm / 4 3/4"

JT-22-3454 17 cm / 6 3/4"

Sharp/Sharp
One Blade Serrated
Super Cut TC

SURGICAL DISTRIBUTION

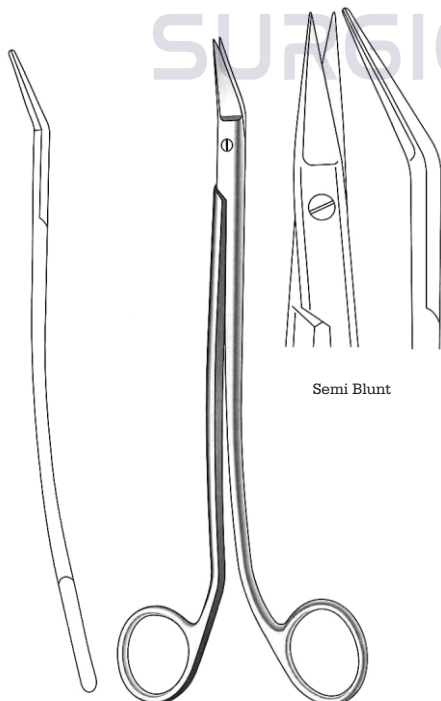

Semi Blunt

Dean

J-22-3462 12 cm / 4 3/4"

J-22-3466 17 cm / 6 3/4"

Semi Blunt/Blunt
Standard

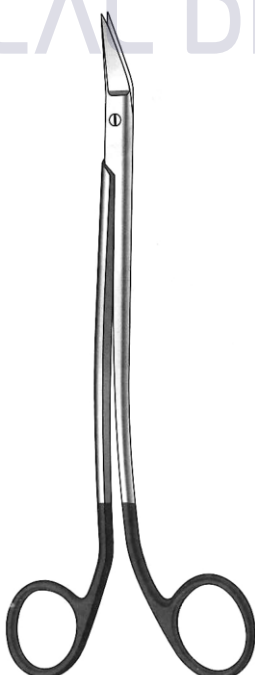

Dean

J-22-3472 12 cm / 4 3/4"

J-22-3476 17 cm / 6 3/4"

Semi Blunt/Blunt
One Blade Serrated
Super Cut



Dean

JT-22-1430 12 cm / 4 3/4"

JT-22-1434 17 cm / 6 3/4"

Semi Blunt/Blunt
TC - Gold

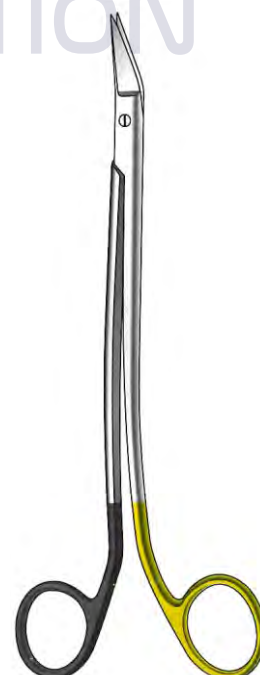

Dean

JT-22-3482 12 cm / 4 3/4"

JT-22-3486 17 cm / 6 3/4"

Semi Blunt/Blunt
One Blade Serrated
Super Cut TC

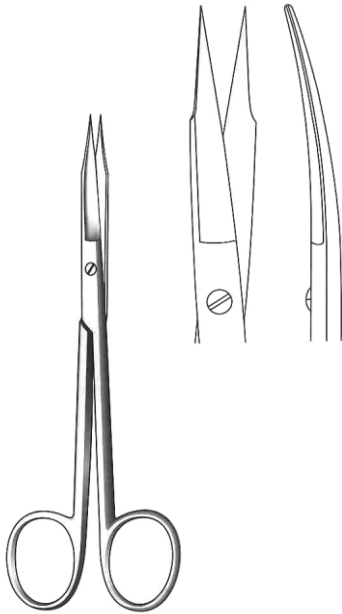

Goldman-Fox

J-22-232 Straight
J-22-233 Curved
 13 cm / 5 1/8"
 Standard



Goldman-Fox

J-22-3490 Straight
J-22-233B Curved
 13 cm / 5 1/8"
 One Blade Serrated
 Super Cut



Goldman-Fox

JT-22-697 Straight
JT-22-698 Curved
 13 cm / 5 1/8"
 TC - Gold



Goldman-Fox

JT-22-3451 Straight
JT-22-3452 Curved
 13 cm / 5 1/8"
 One Blade Serrated
 Super Cut TC

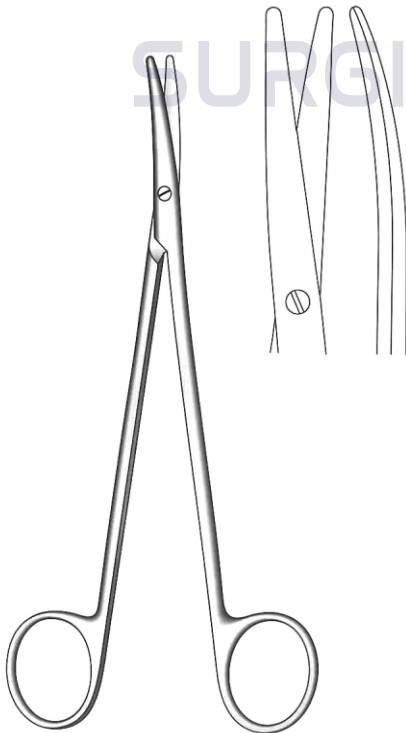
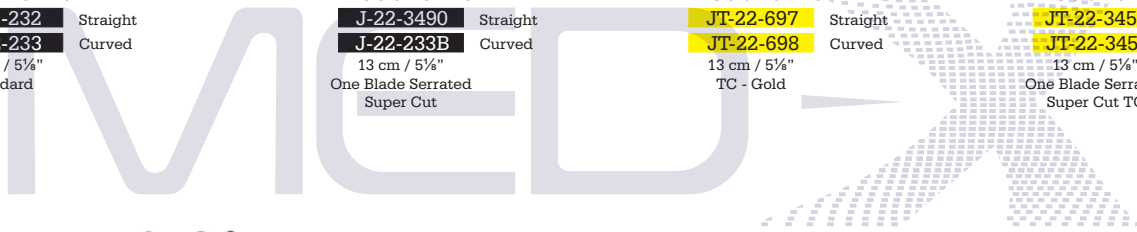

J-22-3510 14.5 cm / 5 3/4"
J-22-3512 18 cm / 7"
J-22-3514 23 cm / 9"
 Curved
 Standard

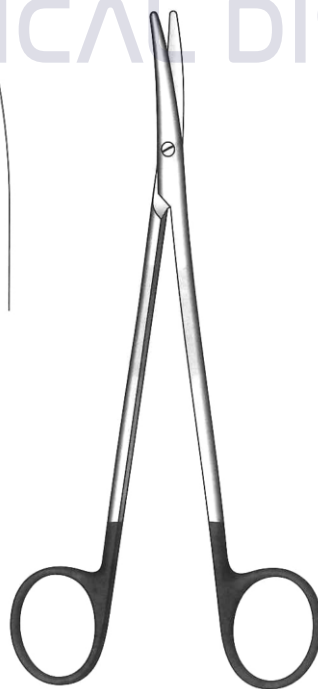

J-22-3520 14.5 cm / 5 3/4"
J-22-3522 18 cm / 7"
J-22-3524 23 cm / 9"
 Curved
 Micro Serration
 Super Cut

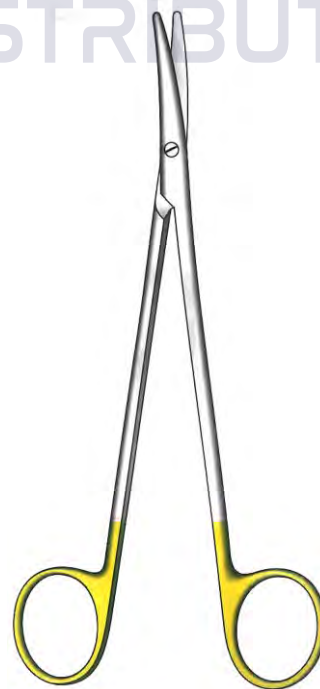

JT-22-1440 14.5 cm / 5 3/4"
JT-22-1442 18 cm / 7"
JT-22-1444 23 cm / 9"
 Curved
 TC - Gold

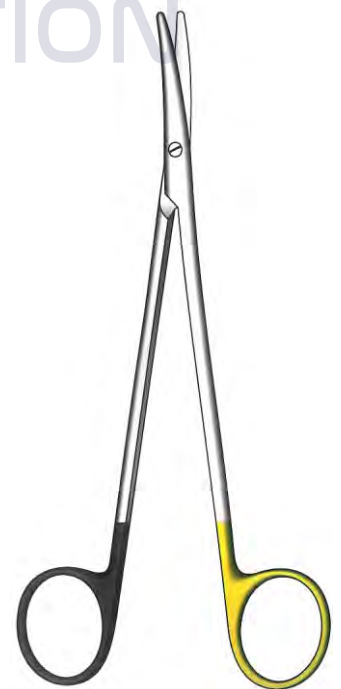

JT-22-3530 14.5 cm / 5 3/4"
JT-22-3532 18 cm / 7"
JT-22-3534 23 cm / 9"
 Curved
 Micro Serration
 Super Cut TC

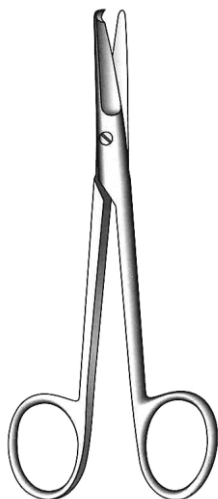

Spencer
J-22-223 9 cm / 3½"
J-22-3540 10.5 cm / 4¼"
J-22-223A 11 cm / 4¼"
J-22-3542 12 cm / 4¼"
J-22-224 13 cm / 5¼"
 Straight

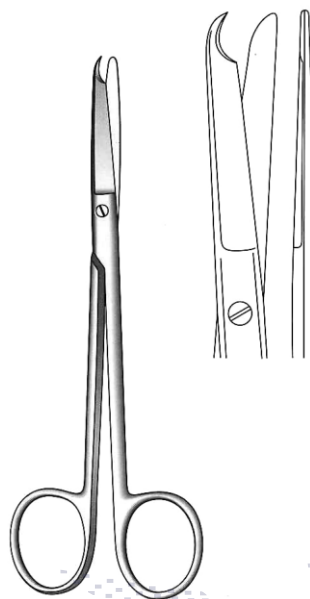

Littauer
J-22-3550 13 cm / 5¼"
J-22-225 14 cm / 5½"
 Straight

MED
SURGICAL DISTRIBUTION

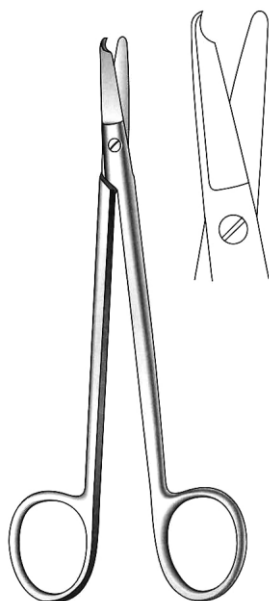

Kelly
J-22-3560
 15 cm / 6"
 Straight

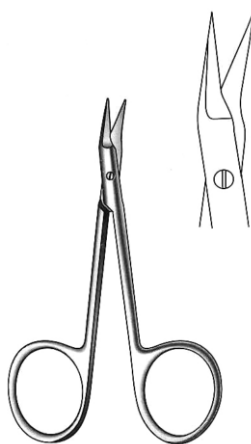

O'Brien
J-22-3570 9 cm / 3½"
J-22-3571 12 cm / 4¼"
 Standard

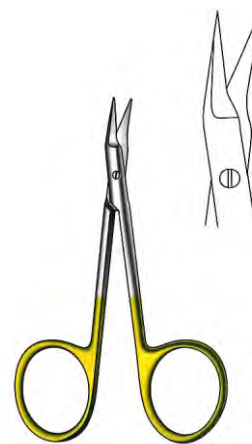

O'Brien
JT-22-1450 9 cm / 3½"
JT-22-1451 12 cm / 4¼"
 TC - Gold

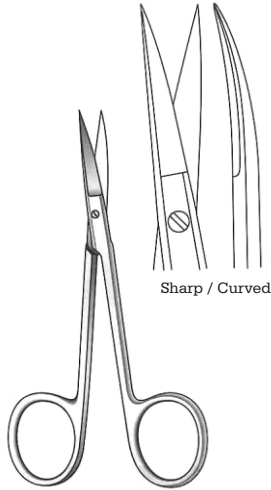

Cottle-Masing
J-22-3580 Sharp
J-22-3582 Blunt
 10 cm / 4"
 Curved, Standard

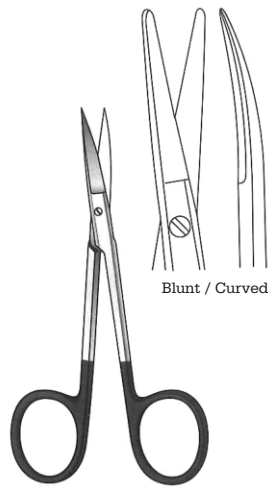

Cottle-Masing
J-22-3590 Sharp
J-22-3592 Blunt
 10 cm / 4", Curved
 One Blade Serrated
 Super Cut

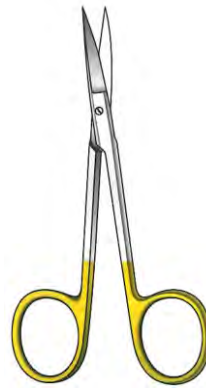

Cottle-Masing
JT-22-1465 Sharp
JT-22-1467 Blunt
 10 cm / 4", Curved
 TC - Gold



Cottle-Masing
JT-22-3560 Sharp
JT-22-3562 Blunt
 10 cm / 4", Curved
 One Blade Serrated
 Super Cut TC

MED 
 SURGICAL DISTRIBUTION

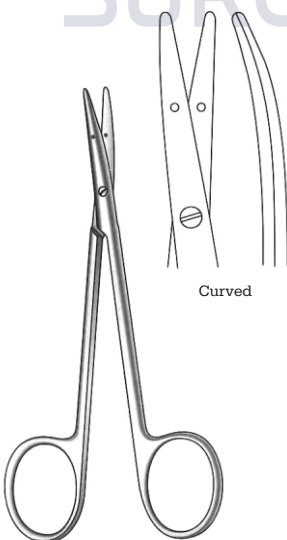

Littler
J-22-3610
 12 cm / 4 3/4"
 Suture carrying curved scissors
 Standard



Littler
J-22-3620
 12 cm / 4 3/4", Curved
 Suture carrying curved scissors
 One Blade Serrated
 Super Cut



Littler
JT-22-1470
 12 cm / 4 3/4", Curved
 Suture carrying curved scissors
 TC - Gold



Littler
JT-22-3630
 12 cm / 4 3/4", Curved
 Suture carrying curved scissors
 One Blade Serrated
 Super Cut TC

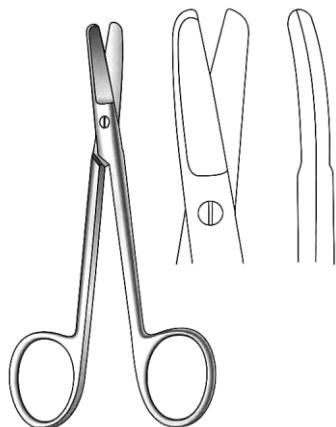

Cottle
J-22-3640
11.5 cm / 4 3/4"
Curved
Bulldog scissors
Standard



Cottle
J-22-3650
11.5 cm / 4 3/4"
Curved
Bulldog scissors
One Blade Serrated
Super Cut



Cottle
JT-22-1480
11.5 cm / 4 3/4"
Curved
Bulldog scissors
TC - Gold



Cottle
JT-22-3660
11.5 cm / 4 3/4"
Curved
Bulldog scissors
One Blade Serrated
Super Cut TC

MEDIX
SURGICAL DISTRIBUTION

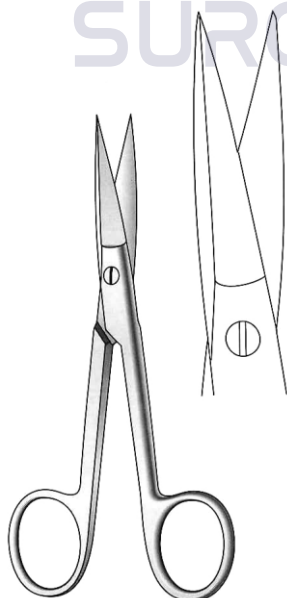

Converse
J-22-0021
13.5 cm / 5 1/4"
Outer edges semi-sharp
Straight
Standard



Converse
J-22-3675
13.5 cm / 5 1/4"
Outer edges semi-sharp
Straight
One Blade Serrated
Super Cut



Converse
JT-22-1490
13.5 cm / 5 1/4"
Outer edges semi-sharp
Straight
TC - Gold



Converse
JT-22-3690
13.5 cm / 5 1/4"
Outer edges semi-sharp
Straight
One Blade Serrated
Super Cut TC

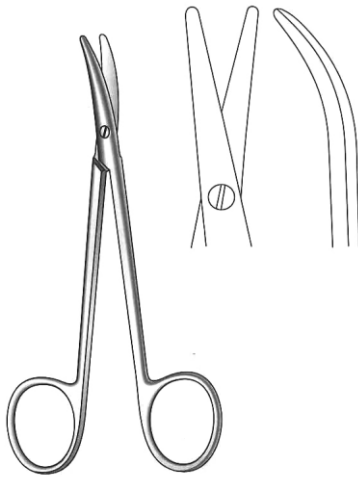

Cinelli
J-22-3670
 11 cm / 4 3/8"
 Curved
 Standard



Cinelli
J-22-3680
 11 cm / 4 3/8"
 Curved
 One Blade Serrated
 Super Cut



Cinelli
JT-22-1500
 11 cm / 4 3/8"
 Curved
 TC - Gold



Cinelli
JT-22-3900
 11 cm / 4 3/8"
 Curved
 One Blade Serrated
 Super Cut TC

MED 
 SURGICAL DISTRIBUTION

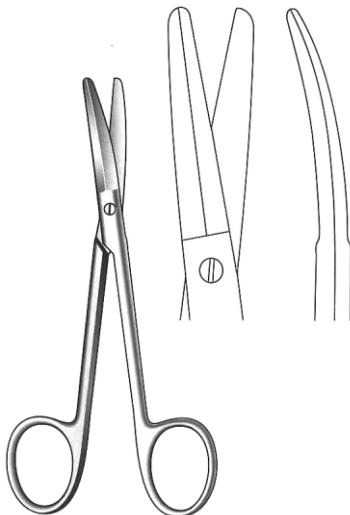

Fomon
J-22-4000
 12.5 cm / 5"
 Curved
 With outer cutting
 Both sides sharp
 Standard



Fomon
J-22-4010
 12.5 cm / 5"
 Curved
 With outer cutting
 Both sides sharp
 One Blade Serrated
 Super Cut



Fomon
JT-22-1510
 12.5 cm / 5"
 Curved
 With outer cutting
 Both sides sharp
 TC - Gold



Fomon
JT-22-4020
 12.5 cm / 5"
 Curved
 With outer cutting
 Both sides sharp
 One Blade Serrated
 Super Cut TC

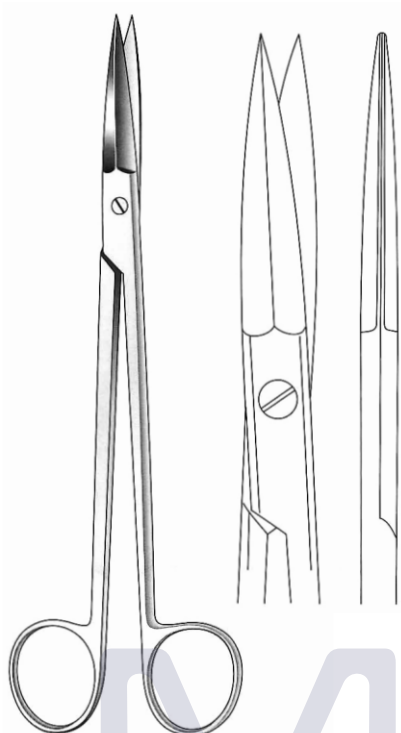

McIndoe
J-22-180
19 cm / 7½"
Cartilage scissors
Outer edges semi sharp
Straight
Standard

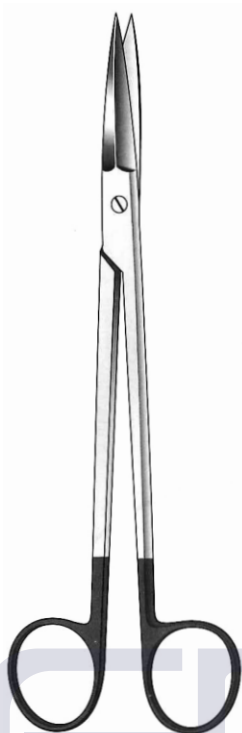

McIndoe
J-22-4030
19 cm / 7½"
Cartilage scissors
Outer edges semi sharp
One Blade Serrated, Straight
Super Cut



McIndoe
JT-22-1520
19 cm / 7½"
Cartilage scissors
Outer edges semi sharp
Straight
TC - Gold



McIndoe
JT-22-4040
19 cm / 7½"
Cartilage scissors
Outer edges semi sharp
One Blade Serrated, Straight
Super Cut TC

SURGICAL DISTRIBUTION

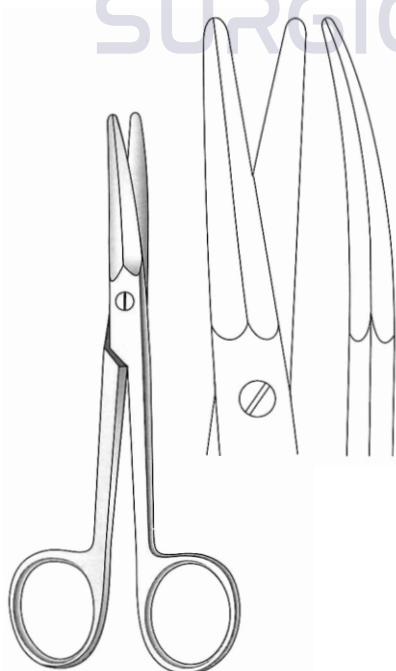

Aufricht
J-22-4050
14 cm / 5½"
Curved
Standard

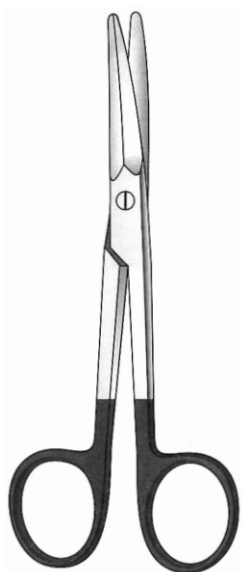

Aufricht
J-22-4060
14 cm / 5½"
Curved
One Blade Serrated
Super Cut

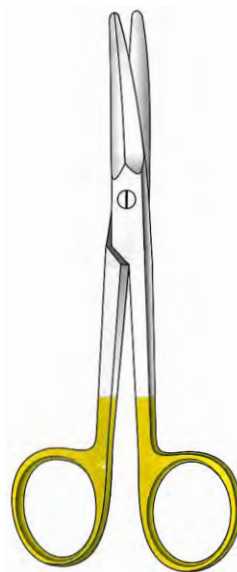

Aufricht
JT-22-1530
14 cm / 5½"
Curved
TC - Gold



Aufricht
JT-22-4070
14 cm / 5½"
Curved
One Blade Serrated
Super Cut TC

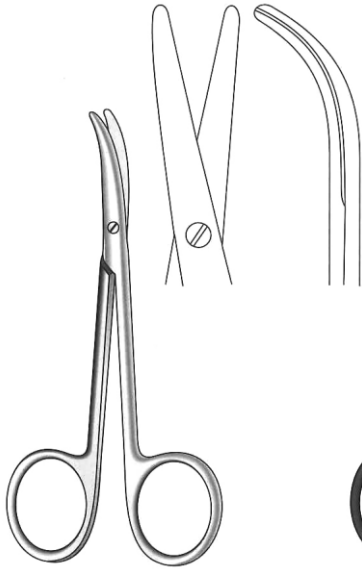

Fomon
J-22-1902
 11.5 cm / 4½"
J-22-1903
 12.5 cm / 5"
 Curved
 Standard

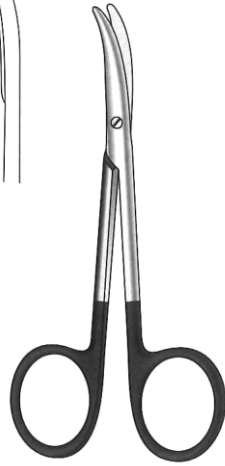

Fomon
J-22-4090
 11.5 cm / 4½"
J-22-4091
 12.5 cm / 5"
 Curved
 One Blade Serrated
 Super Cut



Fomon
JT-22-1540
 11.5 cm / 4½"
JT-22-1542
 12.5 cm / 5"
 Curved
 TC - Gold



Fomon
JT-22-4100
 11.5 cm / 4½"
JT-22-4102
 12.5 cm / 5"
 Curved
 One Blade Serrated
 Super Cut TC

SURGICAL DISTRIBUTION

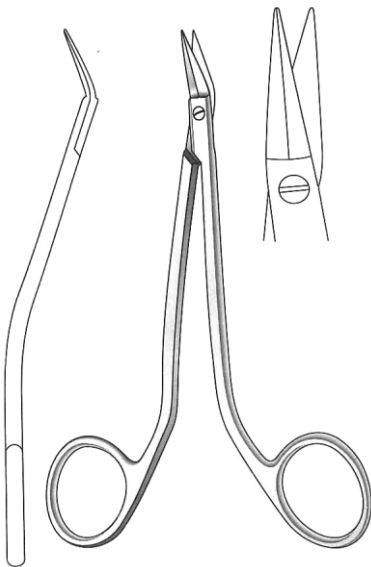

Walter
J-22-4110
 14 cm / 5½"
 Standard

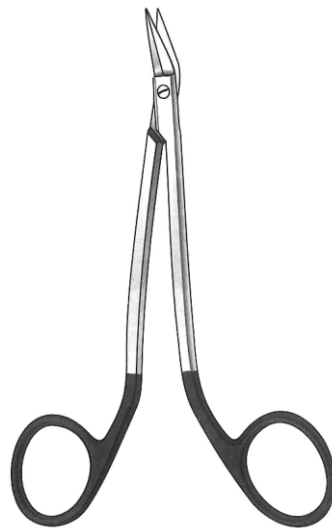

Walter
J-22-4120
 14 cm / 5½"
 One Blade Serrated
 Super Cut

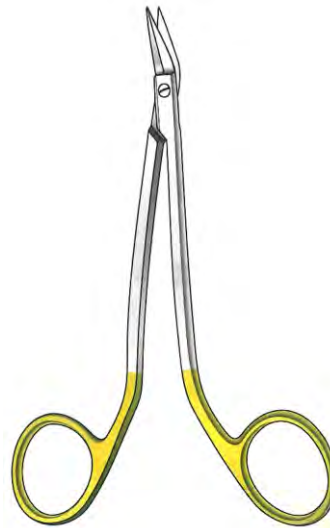

Walter
JT-22-1550
 14 cm / 5½"
 TC - Gold



Walter
JT-22-4130
 14 cm / 5½"
 One Blade Serrated
 Super Cut TC

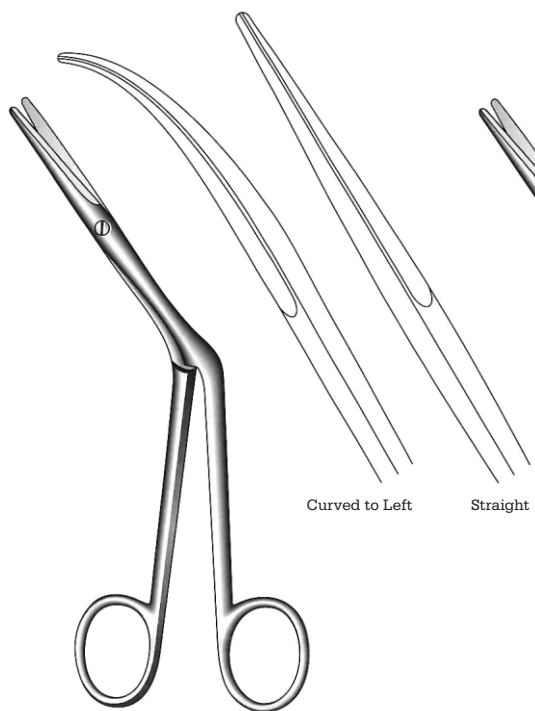

Heymann
J-22-4140 17 cm / 6 3/4"
J-22-4142 18 cm / 7"
 Curved to Left
J-22-189 18 cm / 7"
 Straight

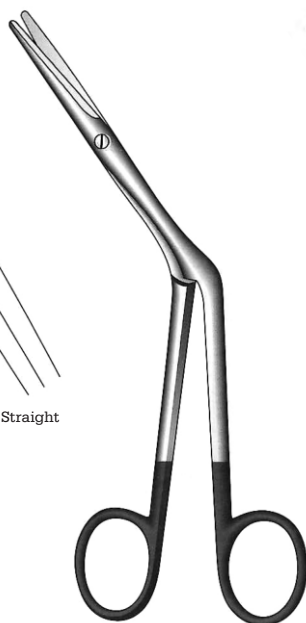

Heymann
J-22-4150 17 cm / 6 3/4"
J-22-4154 18 cm / 7"
 Curved to Left
J-22-1890SC 18 cm / 7"
 Straight
 One Blade Serrated



Heymann
JT-22-1560 17 cm / 6 3/4"
JT-22-1564 18 cm / 7"
 Curved to Left
JT-22-1562 18 cm / 7"
 Straight



Heymann
JT-22-4160 17 cm / 6 3/4"
JT-22-4164 18 cm / 7"
 Curved to Left
JT-22-4162 18 cm / 7"
 Standard
 One Blade Serrated

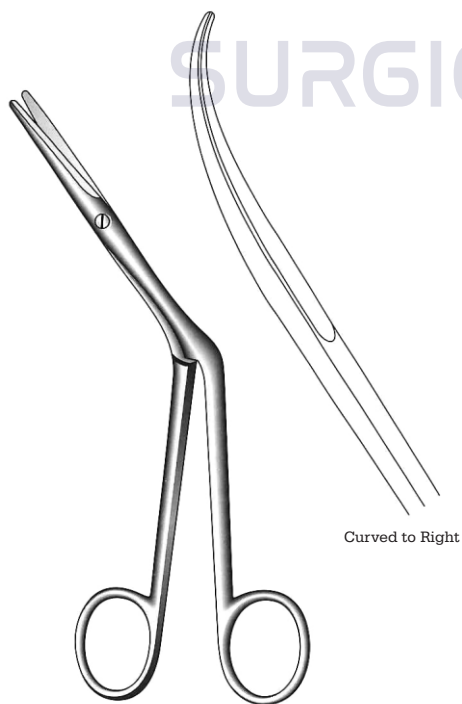

Heymann
J-22-4170 17 cm / 6 3/4"
J-22-4174 18 cm / 7"
 Curved to Right



Heymann
J-22-4180 17 cm / 6 3/4"
J-22-4184 18 cm / 7"
 Curved to Right
 One Blade Serrated



Heymann
JT-22-1570 17 cm / 6 3/4"
JT-22-1574 18 cm / 7"
 Curved to Right



Heymann
JT-22-4190 17 cm / 6 3/4"
JT-22-4194 18 cm / 7"
 Curved to Right
 One Blade Serrated



Heymann
J-22-4200 Straight
J-22-4205 Curved to Left
 20 cm / 8"
 Standard

Heymann
J-22-4210 Straight
J-22-4215 Curved to Left
 20 cm / 8"
 One Blade Serrated
 Super Cut

Heymann
JT-22-1580 Straight
JT-22-1585 Curved to Left
 20 cm / 8"
 TC - Gold

Heymann
JT-22-4220 Straight
JT-22-4225 Curved to Left
 20 cm / 8"
 One Blade Serrated
 Super Cut TC



Heymann
J-22-4235
 Curved to Right
 20 cm / 8"
 Standard

Heymann
J-22-4245
 Curved to Right
 20 cm / 8"
 One Blade Serrated
 Super Cut

Heymann
JT-22-1592
 Curved to Right
 20 cm / 8"
 TC - Gold

Heymann
JT-22-4255
 Curved to Right
 20 cm / 8"
 One Blade Serrated
 Super Cut TC



SURGICAL DISTRIBUTION



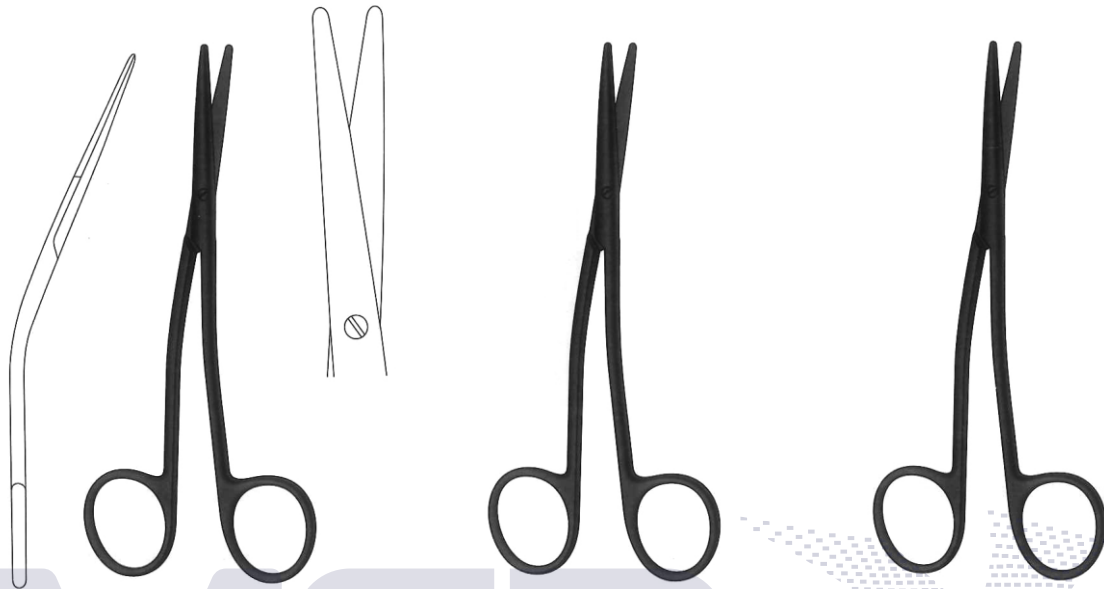

Fomon
J-22-4300
 13 cm / 5 1/4"
 Black finish
 Standard

Fomon
J-22-4310
 13 cm / 5 1/4"
 Black finish
 Curved

Fomon
J-22-4320
 13 cm / 5 1/4"
 Black finish
 Angled

SURGICAL DISTRIBUTION



Fanous
J-22-4330
 14 cm / 5 1/2"
 Standard

Fanous
J-22-4340
 14 cm / 5 1/2"
 One Blade Serrated
 Super Cut

Fanous
JT-22-1590
 14 cm / 5 1/2"
 TC - Gold

Fanous
JT-22-4350
 14 cm / 5 1/2"
 One Blade Serrated
 Super Cut TC



Walter-Cottle
J-22-4360
16 cm / 6¼"
Standard

Walter-Cottle
J-22-4370
16 cm / 6¼"
One Blade Serrated
Super Cut

Walter-Cottle
JT-22-1600
16 cm / 6¼"
TC-Gold

Walter-Cottle
JT-22-4380
16 cm / 6¼"
One Blade Serrated
Super Cut TC

SURGICAL DISTRIBUTION



Giunta
J-22-4390
13.5 cm / 5¼"
Standard

Giunta
J-22-4400
13.5 cm / 5¼"
One Blade Serrated
Super Cut

Giunta
JT-22-1610
13.5 cm / 5¼"
TC-Gold

Giunta
JT-22-4410
13.5 cm / 5¼"
One Blade Serrated
Super Cut TC



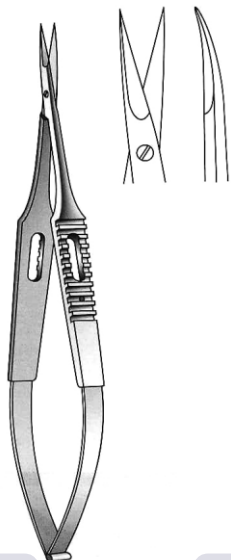

Micro Scissors
J-22-4490 Straight
J-22-4492 Curved
 15 cm / 6"
 Standard
 Extra Light Weight

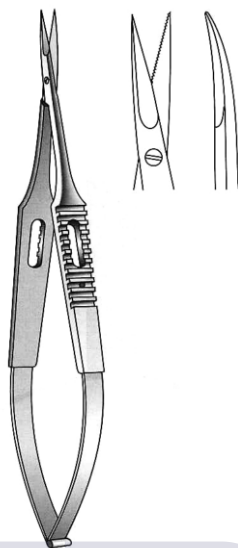

Micro Scissors
J-22-4500 Straight
J-22-4502 Curved
 15 cm / 6"
 Serrated cutting edges
 Standard
 Extra Light Weight

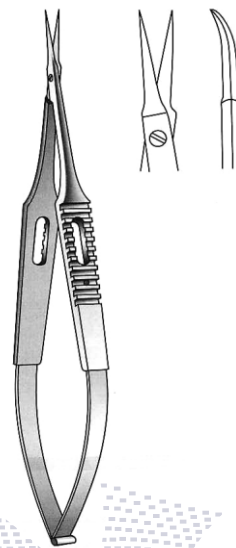

Micro Scissors
J-22-4510 Straight
J-22-4512 Curved
 15 cm / 6"
 Vannas-type cutting edges
 Standard
 Extra Light Weight

SURGICAL DISTRIBUTION

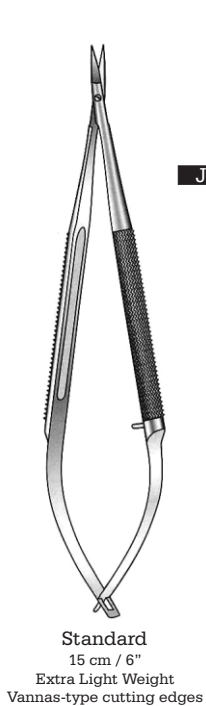

J-22-4520 Straight
J-22-4522 Curved

Standard
 15 cm / 6"
 Extra Light Weight
 Vannas-type cutting edges

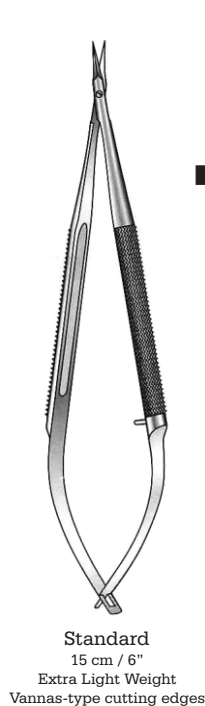

J-22-4530 Straight
J-22-4532 Curved

Standard
 15 cm / 6"
 Extra Light Weight
 Vannas-type cutting edges

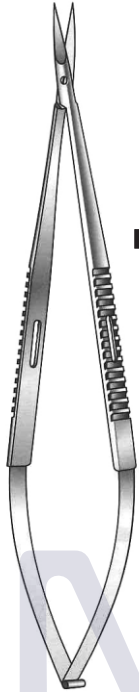

J-22-4540
 Straight
 Sharp



J-22-4542
 Curved
 Sharp



J-22-4544
 Curved 45°
 Sharp



J-22-4546
 Curved 45°
 Blunt



Jacobson
 18 cm / 7"
 Extra Light Weight
 Micro Scissors

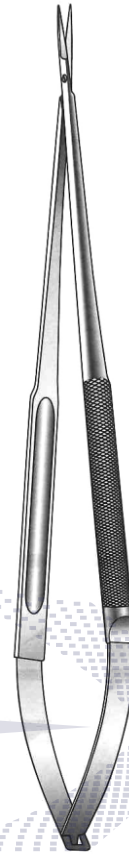

Standard
J-22-4550
 23 cm / 9"
 Straight
 Extra Light Weight

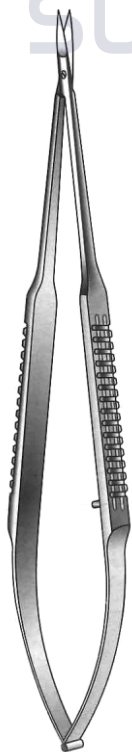

J-22-4560
J-22-4564
 Straight



J-22-4562
J-22-4566
 Curved



15 cm / 6"
 18 cm / 7"

Micro Scissors
 Extra Light Weight

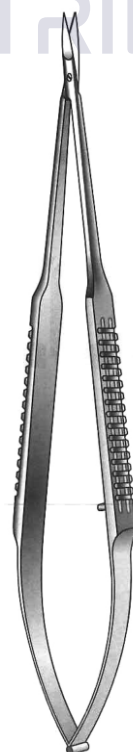

J-22-4570
J-22-4574
 Straight



J-22-4572
J-22-4576
 Curved



15 cm / 6"
 18 cm / 7"

Micro Scissors
 Extra Light Weight
 Serrated

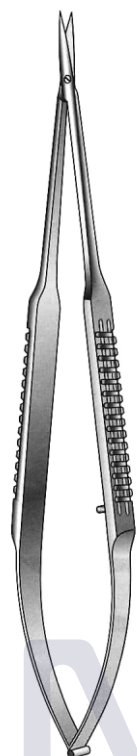

Micro Scissors
Extra Light Weight



- J-22-4580** Straight
- J-22-4582** Curved
- 15 cm / 6"
- J-22-4584** Straight
- J-22-4586** Curved
- 18 cm / 7"
- Sharp



Micro Scissors
Extra Light Weight



- J-22-4590** Straight
- J-22-4592** Curved
- 15 cm / 6"
- J-22-4594** Straight
- J-22-4596** Curved
- 18 cm / 7"
- Blunt

SURGICAL DISTRIBUTION

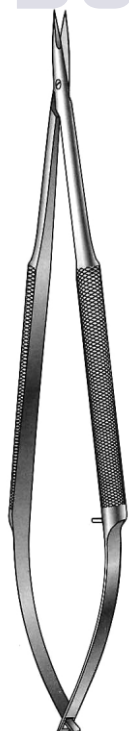

- Standard
- J-22-4601** 15 cm / 6"
- J-22-4602** 18 cm / 7"
- J-22-4604** 21 cm / 8¼"
- Straight

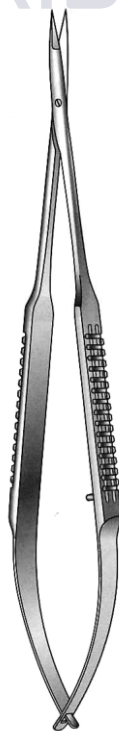

- Standard
- J-22-4611** 15 cm / 6"
- J-22-4612** 18 cm / 7"
- J-22-4614** 21 cm / 8¼"
- Curved



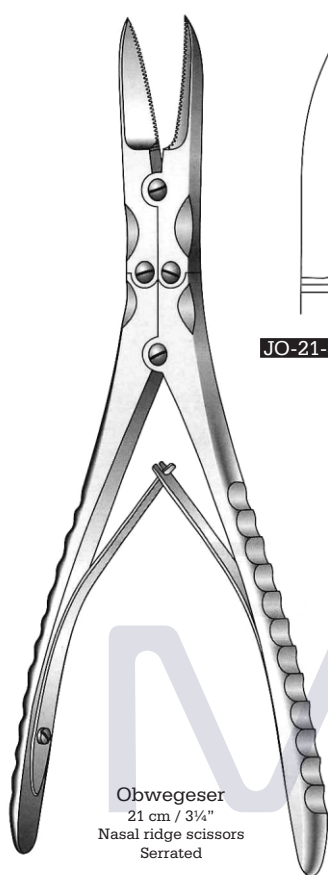

Obwegeser
21 cm / 3 1/4"
Nasal ridge scissors
Serrated

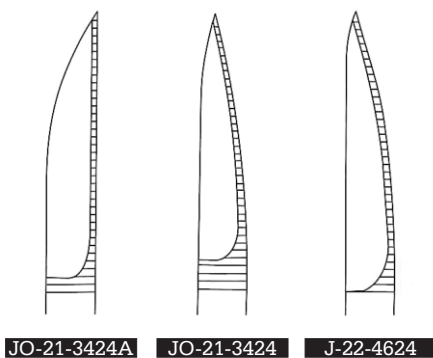

JO-21-3424A JO-21-3424 J-22-4624

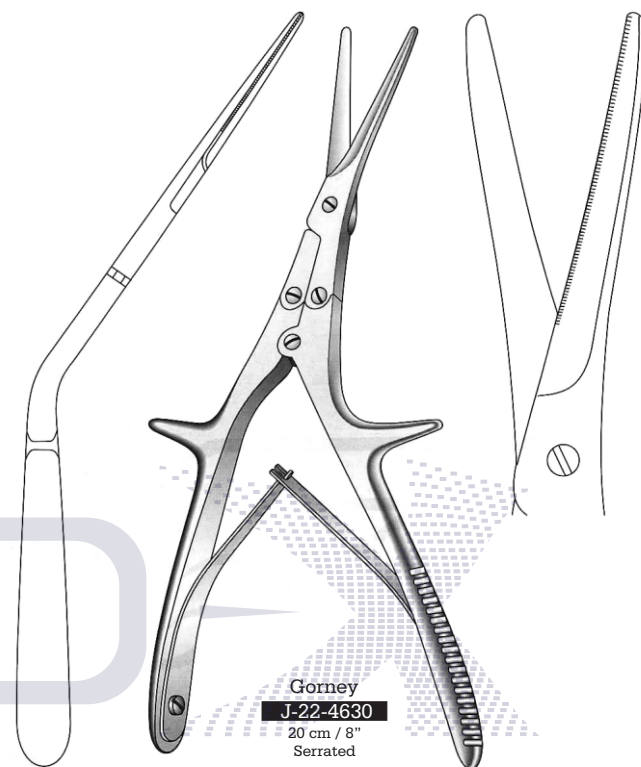

Gorney
J-22-4630
20 cm / 8"
Serrated

MEDIX
SURGICAL DISTRIBUTION

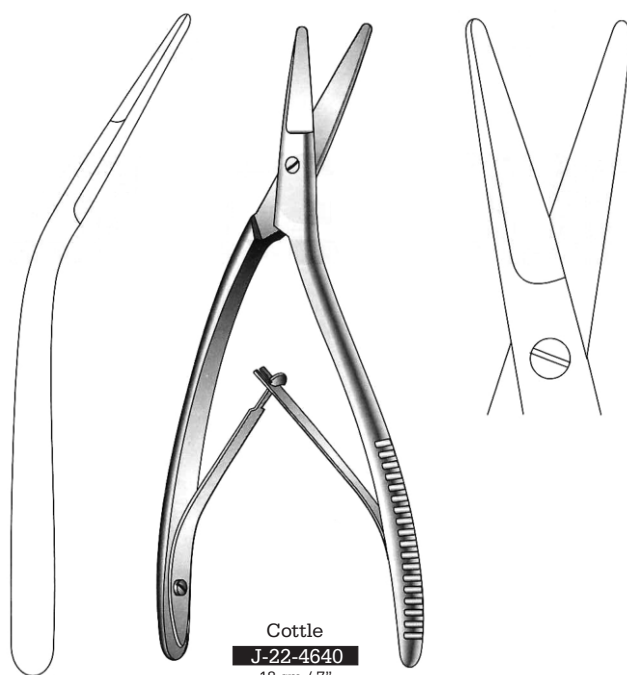

Cottle
J-22-4640
18 cm / 7"
Nasal septum scissors

ENT & Plastic Surgery Instruments



Forceps

Forceps

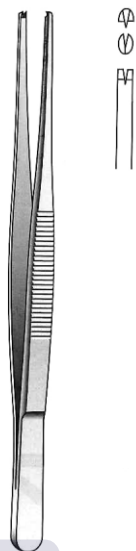

J-16-700
14.5 cm / 5 3/4"

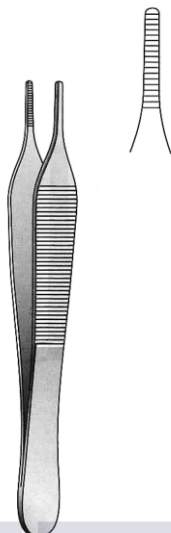

Hudson-Ewald
J-16-705
12 cm / 4 3/4"

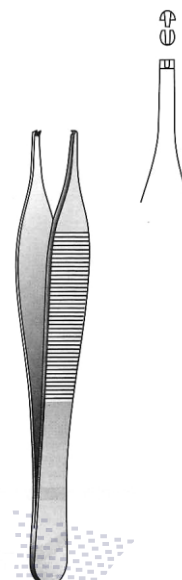

Hudson-Ewald
J-16-710
12 cm / 4 3/4"
1:2 Teeth

MEDIX
SURGICAL DISTRIBUTION

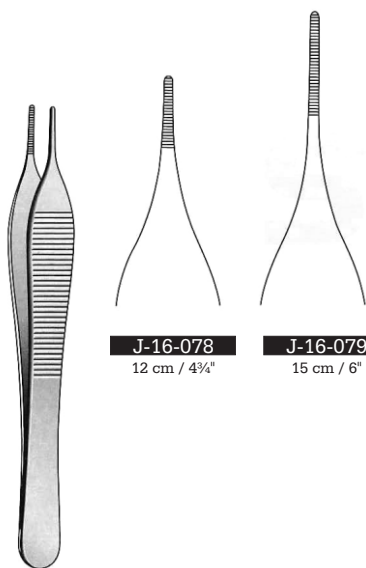

J-16-078
12 cm / 4 3/4"

J-16-079
15 cm / 6"

Adson



Adson
Normal Profile

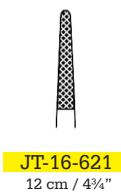

JT-16-621
12 cm / 4 3/4"



JT-16-622
12 cm / 4 3/4"

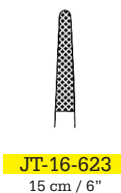

JT-16-623
15 cm / 6"

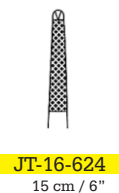

JT-16-624
15 cm / 6"



Adson
JT-16-800
15 cm / 6"

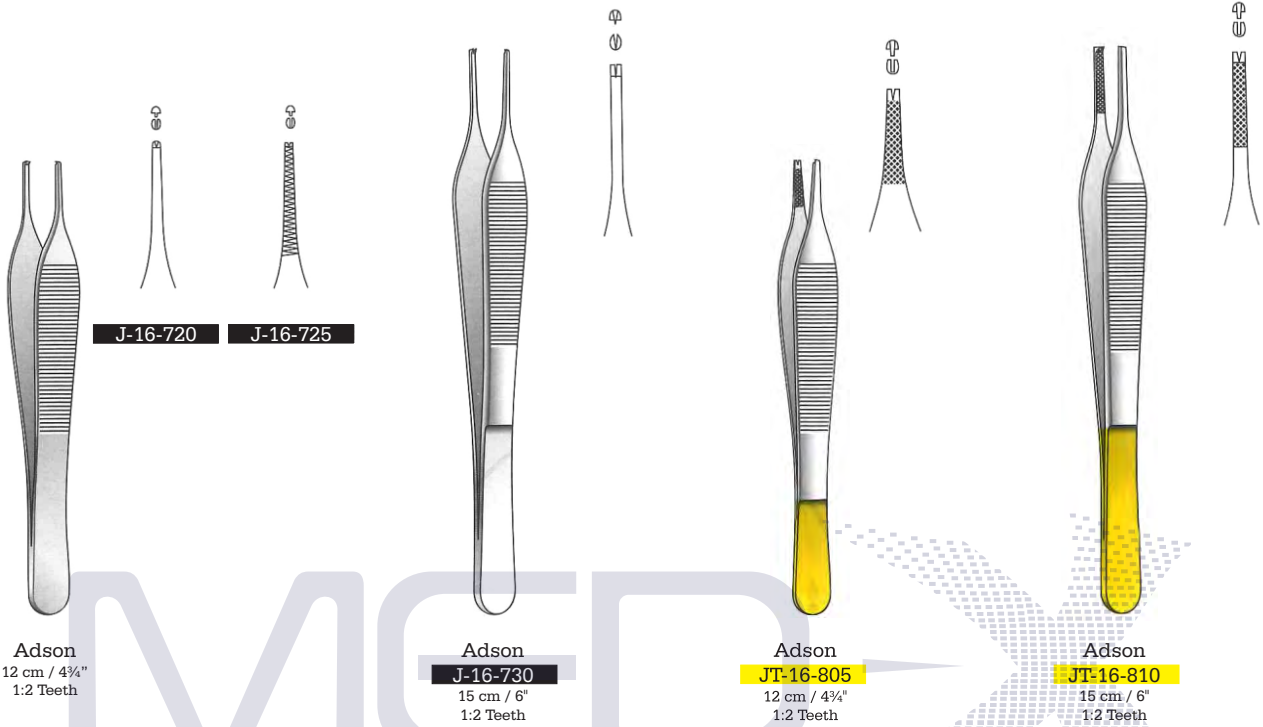

Adson
 12 cm / 4 3/4"
 1:2 Teeth

Adson
J-16-730
 15 cm / 6"
 1:2 Teeth

Adson
JT-16-805
 12 cm / 4 3/4"
 1:2 Teeth

Adson
JT-16-810
 15 cm / 6"
 1:2 Teeth

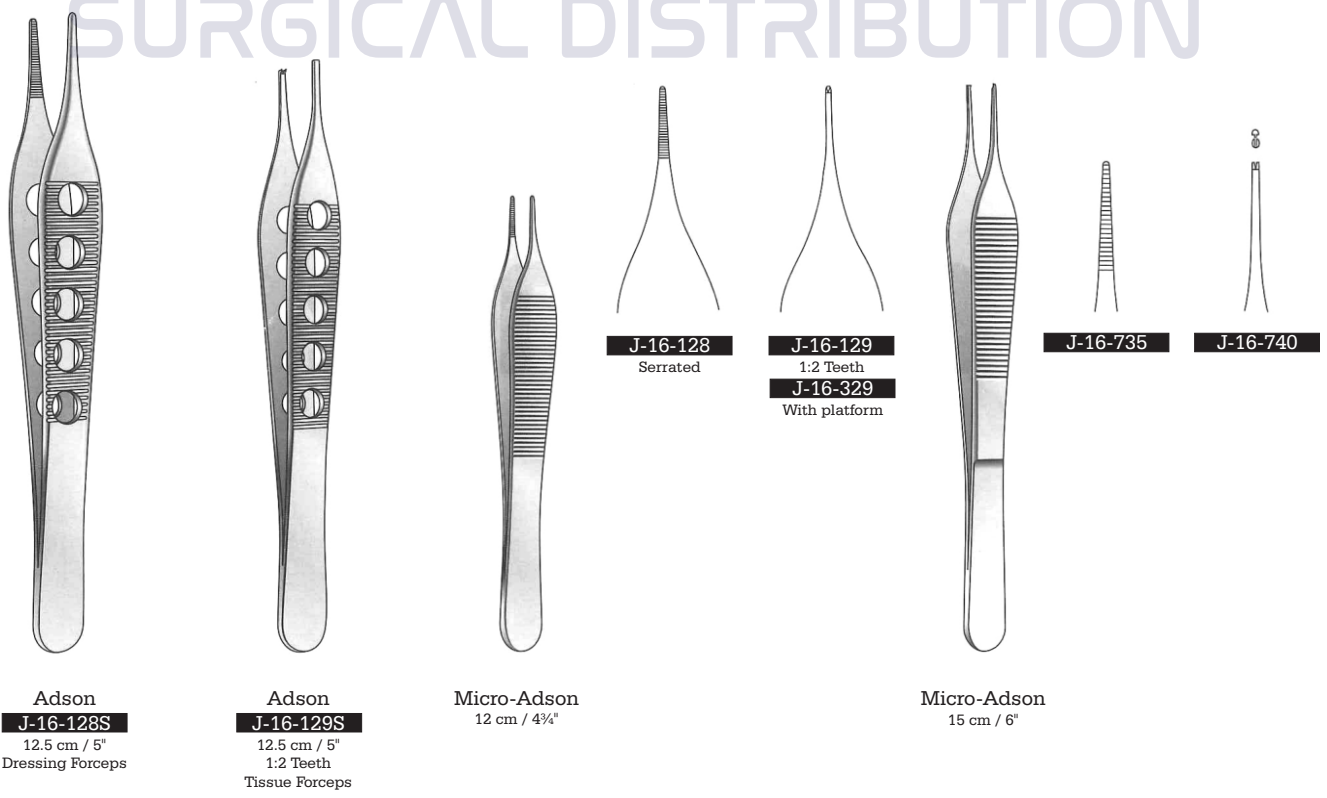

Adson
J-16-128S
 12.5 cm / 5"
 Dressing Forceps

Adson
J-16-129S
 12.5 cm / 5"
 1:2 Teeth
 Tissue Forceps

Micro-Adson
 12 cm / 4 3/4"

Micro-Adson
 15 cm / 6"

J-16-128
 Serrated

J-16-129
 1:2 Teeth
J-16-329
 With platform

J-16-735

J-16-740

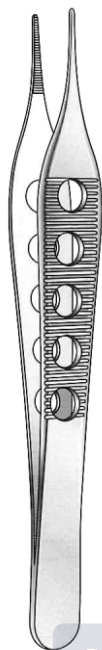

Micro-Adson
J-16-1130
12.5 cm / 5"
Dressing Forceps

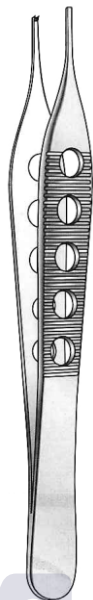

Micro-Adson
J-16-1132
12.5 cm / 5"
1:2 Teeth
Tissue Forceps



J-16-130
7:7 Teeth



J-16-130B
9:9 Teeth

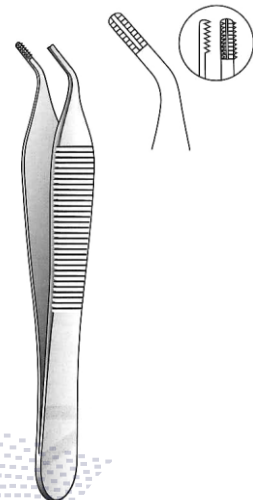

Adson-Brown
J-16-130C
12 cm / 4 3/4"
7:7 Teeth

SURGICAL DISTRIBUTION



Adson-Graefe
J-16-755
12 cm / 4 3/4"



Semken

J-16-086
12.5 cm / 5"

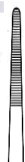

J-16-086A
12.5 cm / 5"



J-16-087
15 cm / 6"



J-16-087A
15 cm / 6"

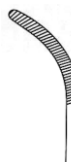

Semken
1:2 Teeth

J-16-088
12.5 cm / 5"



J-16-089A
12.5 cm / 5"



J-16-089
15 cm / 6"



J-16-089B
15 cm / 6"



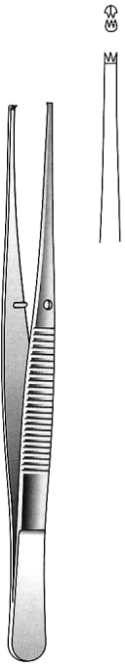

Semken
J-16-780
 12.5 cm / 5"



McIndoe
 15 cm / 6"



J-16-082



J-16-282
 1:2 Teeth



Gillies
J-16-083
 15 cm / 6"
 1:2 Teeth



Waugh
 15 cm / 6"



J-16-085



J-16-190
 1:2 Teeth



Waugh
 20 cm / 8"



J-16-187



J-16-192
 1:2 Teeth



Duehrssen
J-16-111
 20 cm / 8"



Gruenwald (Jansen)
J-31-1095 14 cm / 5½"
J-31-1100 16 cm / 6¼"
J-31-1110 20 cm / 8"
 Bayonet Forceps

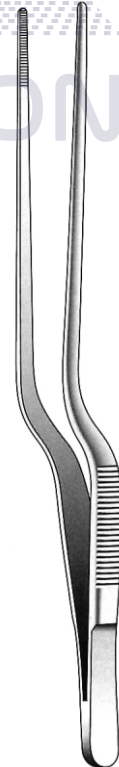

Gruenwald
J-32-3575 14 cm / 5½"
J-32-3580 16 cm / 6¼"
J-32-373 20 cm / 8"
 Bayonet Forceps
 With Pin

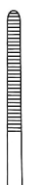

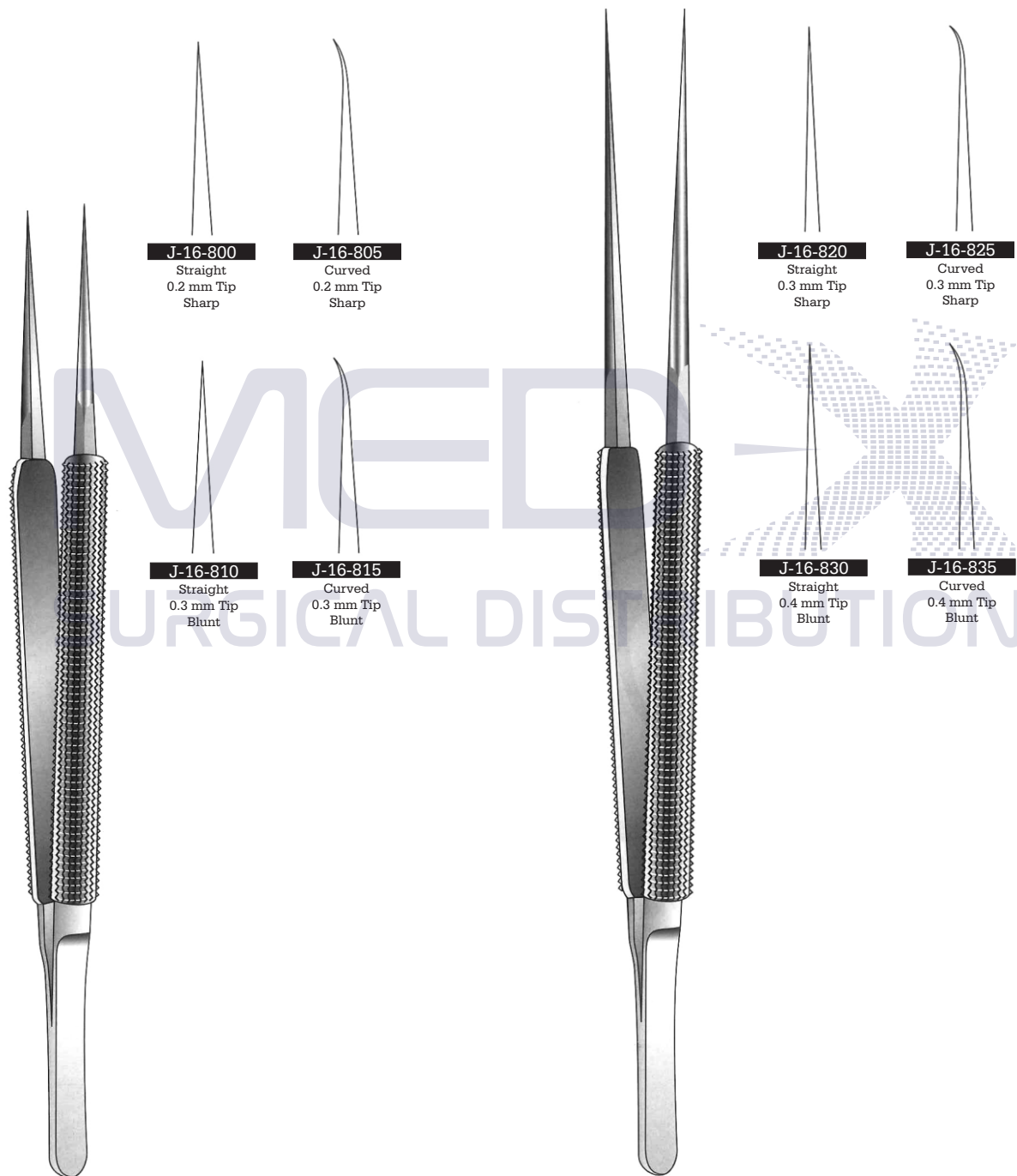

J-16-800
Straight
0.2 mm Tip
Sharp

J-16-805
Curved
0.2 mm Tip
Sharp

J-16-820
Straight
0.3 mm Tip
Sharp

J-16-825
Curved
0.3 mm Tip
Sharp

J-16-810
Straight
0.3 mm Tip
Blunt

J-16-815
Curved
0.3 mm Tip
Blunt





J-16-830
Straight
0.4 mm Tip
Blunt

J-16-835
Curved
0.4 mm Tip
Blunt

Micro Forceps
15 cm / 6"



Micro Forceps
18 cm / 7"
Extremely light weight
Well balanced
Fatigueless working





			
J-16-850 15 cm / 6"	J-16-851	J-16-860 15 cm / 6"	J-16-861
J-16-854 18 cm / 7"	J-16-855	J-16-864 18 cm / 7"	J-16-865
J-16-858 21 cm / 8 1/4"	J-16-859	J-16-868 21 cm / 8 1/4"	J-16-869
Straight 0.4 mm tip Sharp	Curved 0.4 mm tip Sharp	Straight 0.8 mm tip Blunt	Curved 0.8 mm tip Blunt

MED 
 SURGICAL DISTRIBUTION



	
J-16-880 15 cm / 6"	J-16-881
J-16-884 18 cm / 7"	J-16-885
J-16-888 21 cm / 8 1/4"	J-16-889
1 mm Serrated Tips	2 mm Serrated Tips

	
J-16-1000 15 cm / 6"	J-16-1001
J-16-1004 18 cm / 7"	J-16-1005
J-16-1008 21 cm / 8 1/4"	J-16-1009
1 mm diamond dust coated tips	2 mm diamond dust coated tips





Micro Forceps

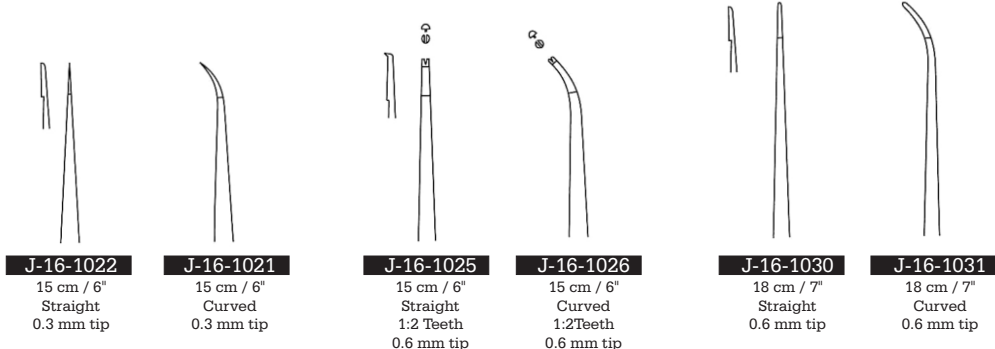

MEDIX
SURGICAL DISTRIBUTION

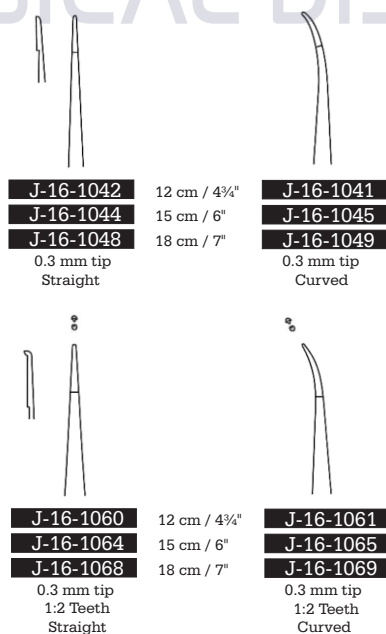

J-16-1080
23 cm / 9"
0.6 mm tip
Straight

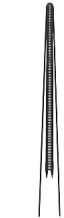

16 cm / 6 1/4"



20 cm / 8"



24 cm / 9 1/2"

DeBakey

J-27-5950	15 cm / 6"
J-27-600	16 cm / 6 1/4"
J-27-605	20 cm / 8"
J-27-610	24 cm / 9 1/2"

1.5 mm



Nelson

J-16-1090	15 cm / 6"
J-16-113	23 cm / 9"



J-16-1101
 16 cm / 6 1/4"

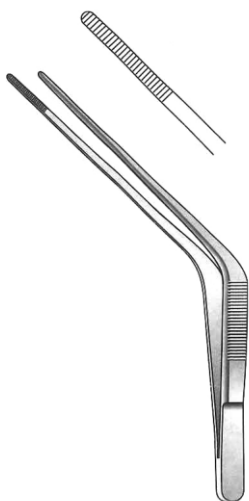

Troeltsch (Wilde)

J-31-1070	12 cm / 4 3/4"
J-31-1072	13 cm / 5 1/4"

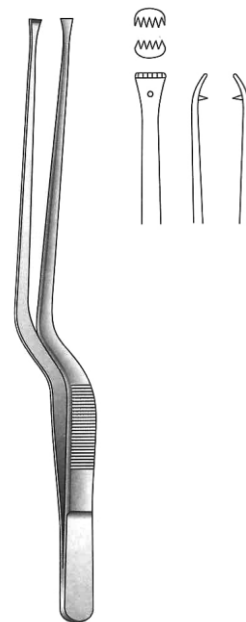

Walter

J-16-1111	16 cm / 6 1/4"
------------------	----------------

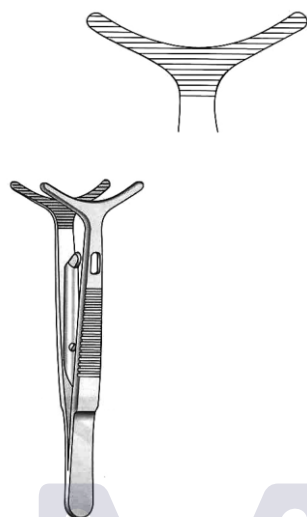

Walter
J-16-1121
8 cm / 3 1/4"
Lid grasping forceps

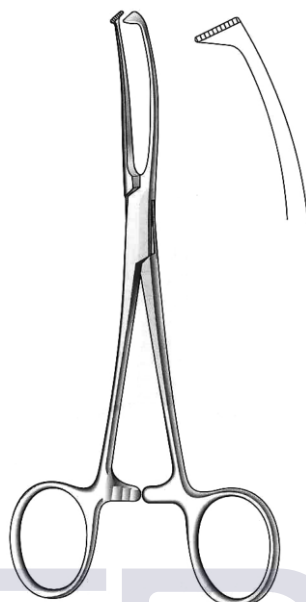

Fox
J-16-1125
15.5 cm / 6"
Tissue grasping forceps

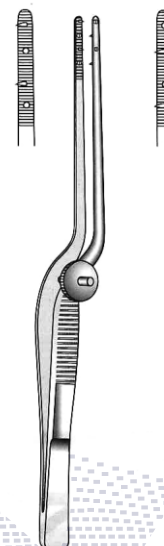

Cottle
J-32-1608
14 cm / 5 1/2"
1.7 mm wide with teeth

SURGICAL DISTRIBUTION



Cottle
J-16-1134
15 cm / 6"



Fox
Without Lock



J-16-1138
13 cm / 5"

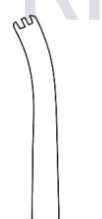

J-16-1140
15 cm / 6"

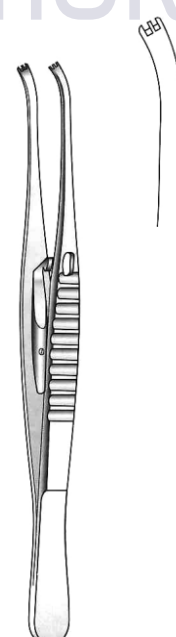

Fox
J-16-1150
15 cm / 6"
With Lock

ENT & Plastic Surgery
Instruments



Needle
Holders

Needle Holders

Needle Holders

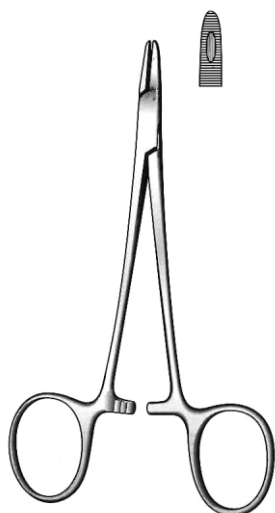

Derf
J-24-001
12 cm / 4¾"

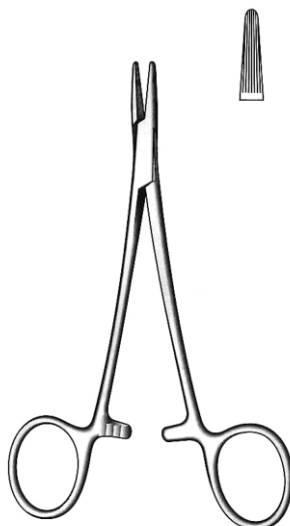

Derf-Converse
J-24-002
12.5 cm / 5"

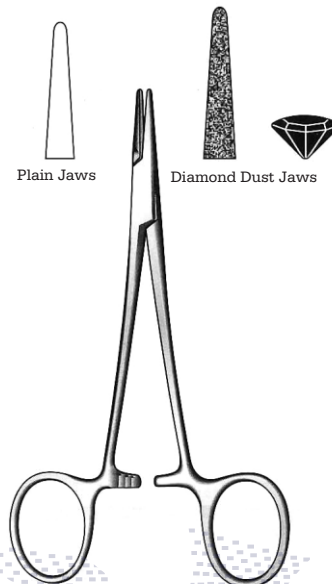

Plain Jaws Diamond Dust Jaws

Halsey
J-24-004 Plain Jaw
J-24-204 Delicate, Plain Jaw
12.5 cm / 5"
J-24-0040 Serrated Jaw
J-24-2000 Diamond Dust Jaw
13.5 cm / 5¼"

MED
SURGICAL DISTRIBUTION

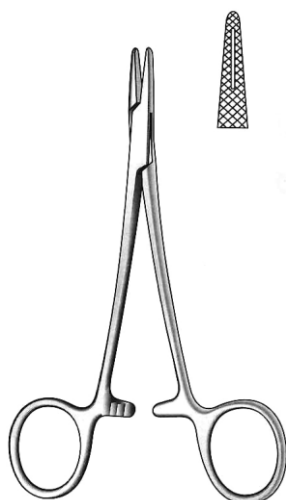

Wright (Derf)
J-24-1530
12.5 cm / 5"

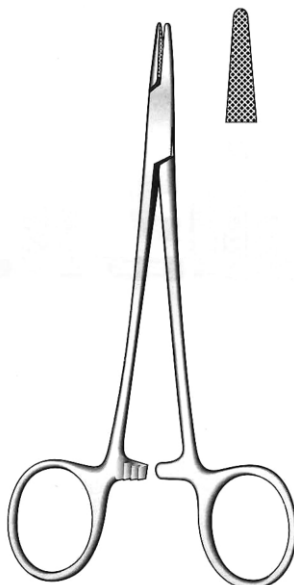

Hegar-Baumgartner
J-24-008
14 cm / 5½"

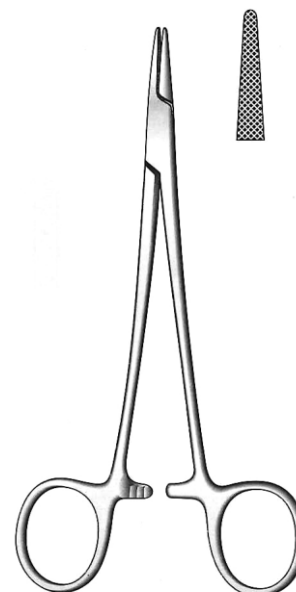

Crile-Murray
J-24-010
15 cm / 6"

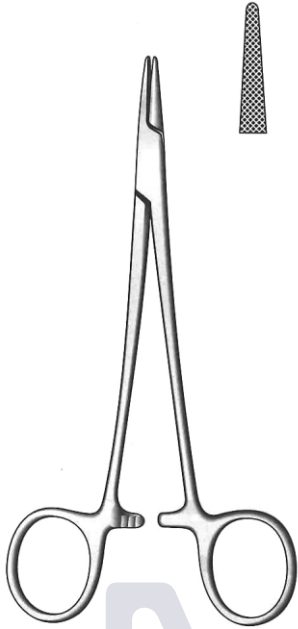

Crile-Wood
J-24-2010 15 cm / 6"
J-24-2012 18 cm / 7"
J-24-2014 20 cm / 8"
J-24-2016 23 cm / 9"

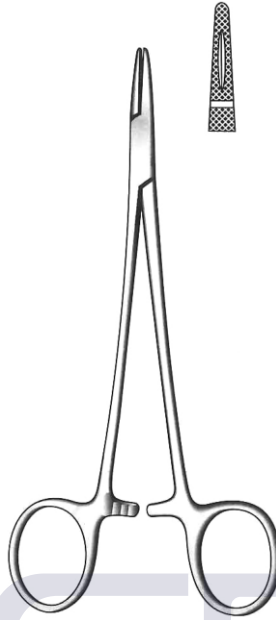

Crile-Wood
J-24-011 15 cm / 6"
J-24-012 18 cm / 7"
J-24-013 20 cm / 8"

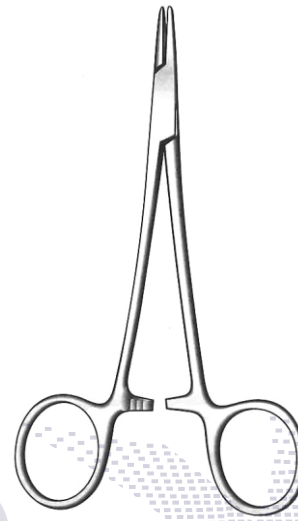

Webster
 13 cm / 5 1/8"
 Delicate

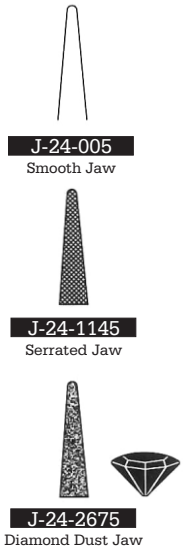

SURGICAL DISTRIBUTION

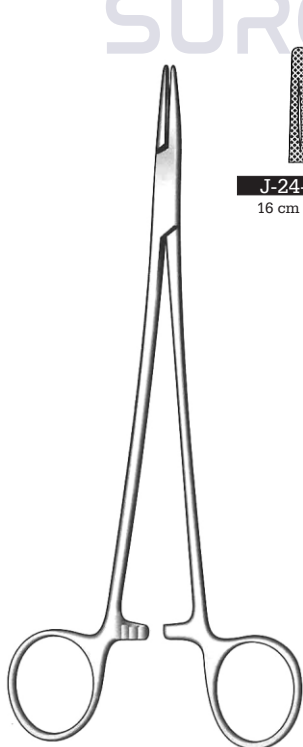

Mayo-Hegar
Delicate

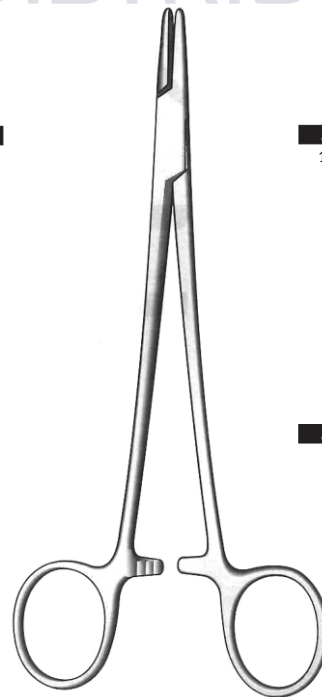
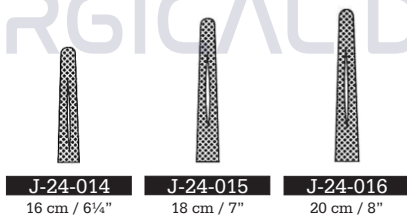

Mayo-Hegar

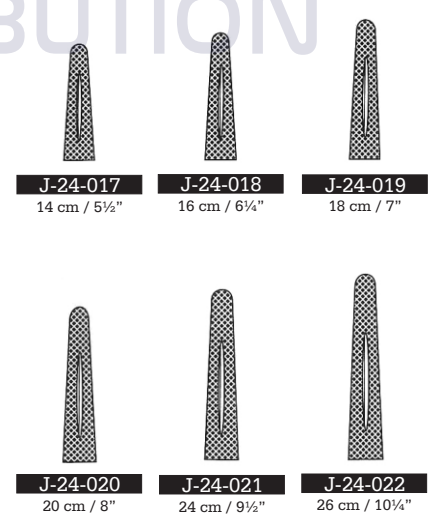

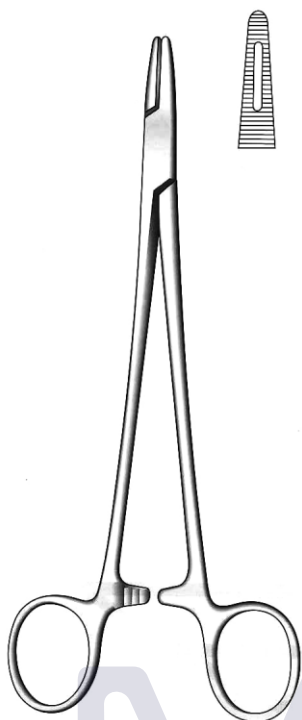

Adson
J-24-023
18 cm / 7"

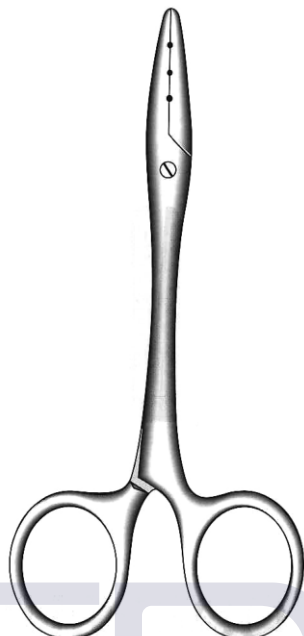

Bruce-Clarke
J-24-009
12.5 cm / 5"

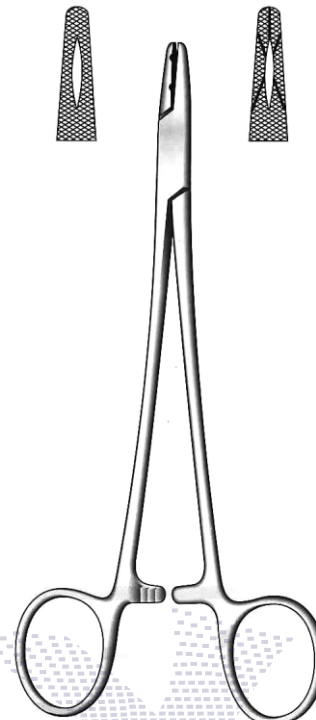

Metzenbaum
J-24-024
18 cm / 7"

SURGICAL DISTRIBUTION

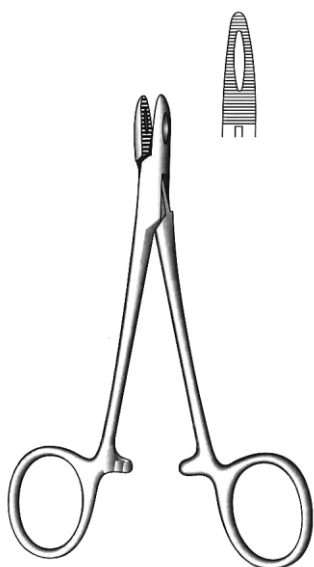

Collier
J-24-003
12.5 cm / 5"

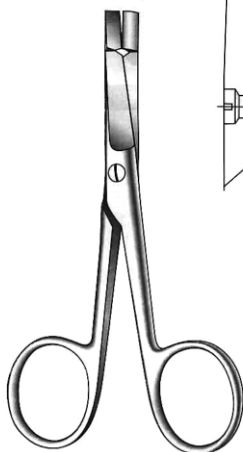

Eiselsberg
J-24-048
11.5 cm / 4½"

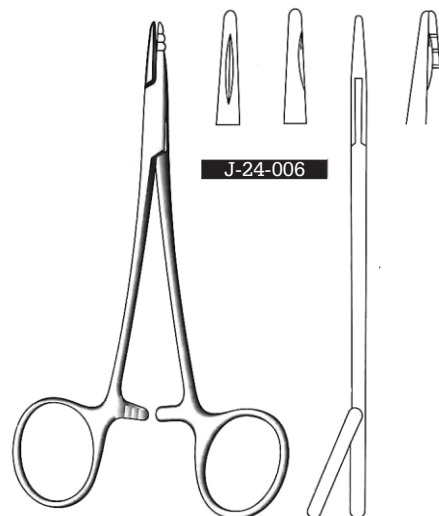

Neivert
13 cm / 5 1/8"

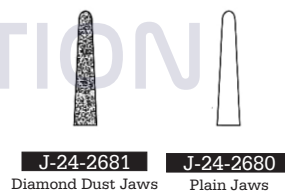

J-24-2681 Diamond Dust Jaws
J-24-2680 Plain Jaws

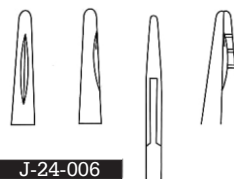

J-24-006

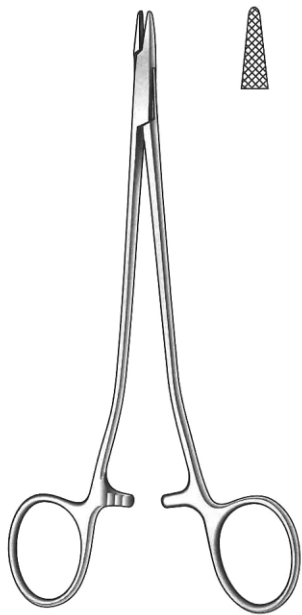

Senning
J-24-1560
 17 cm / 6³/₄"

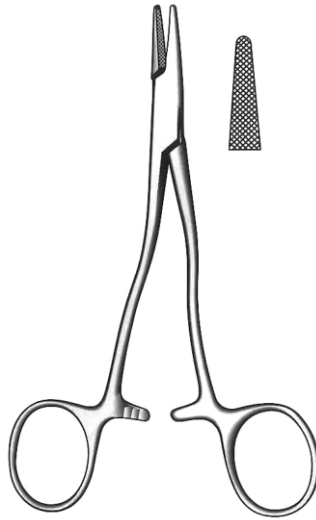

Kilner
J-24-007
 13.5 cm / 5¹/₄"

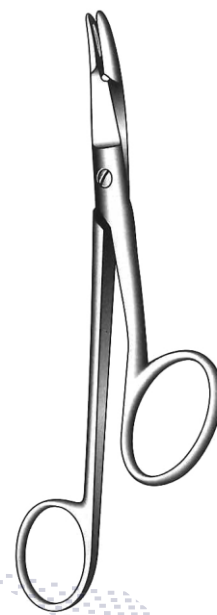

Gillies
J-24-037 Right hand
J-24-038 Left hand
 12.5 cm / 5"
J-24-039 Right hand
J-24-040 Left hand
 16 cm / 6¹/₄"
 With Scissors & Serrated Jaws

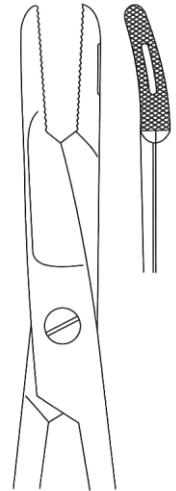

MED
 SURGICAL DISTRIBUTION

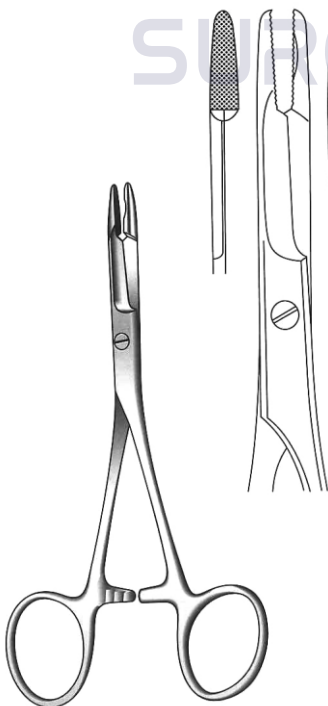

Olsen-Hegar
J-24-2020 12 cm / 4³/₄"
J-24-041 14 cm / 5¹/₂"

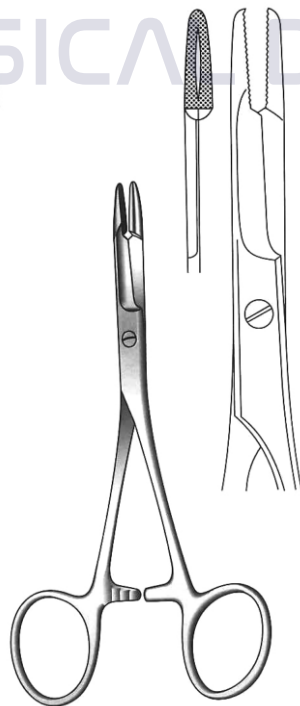

Olsen-Hegar
J-24-1200 14 cm / 5¹/₂"
J-24-1201 16 cm / 6¹/₄"
J-24-1202 17 cm / 6³/₄"
J-24-1203 19 cm / 7¹/₂"



Olsen-Hegar
J-24-044 12 cm / 4³/₄", Mini
J-24-045 14 cm / 5¹/₂"
J-24-046 16 cm / 6¹/₄"
J-24-047 18 cm / 7"

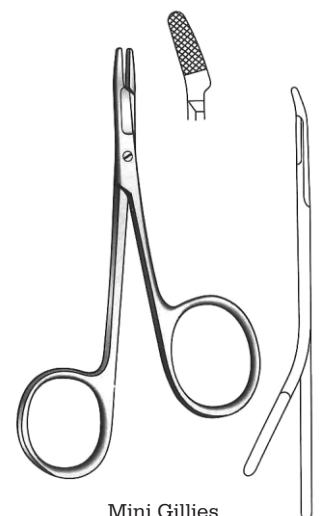

Mini Gillies
 10 cm / 4"
J-24-210 Left hand
J-24-211 Right hand



J-24-240	13 cm / 5 1/8"	J-24-270
J-24-241	16 cm / 6 1/4"	J-24-271
J-24-242	18 cm / 7"	J-24-272
J-24-243	20 cm / 8"	J-24-273
J-24-244	23 cm / 9"	J-24-274

Standard



J-24-255	13 cm / 5 1/8"	J-24-285
J-24-256	16 cm / 6 1/4"	J-24-286
J-24-257	18 cm / 7"	J-24-287
J-24-258	20 cm / 8"	J-24-288
J-24-259	23 cm / 9"	J-24-289

Serrated



J-24-2030	13 cm / 5 1/8"	J-24-2041
J-24-2031	16 cm / 6 1/4"	J-24-2042
J-24-2032	18 cm / 7"	J-24-2043
J-24-2033	20 cm / 8"	J-24-2044
J-24-2034	23 cm / 9"	J-24-2045



Diamond dust coated jaw

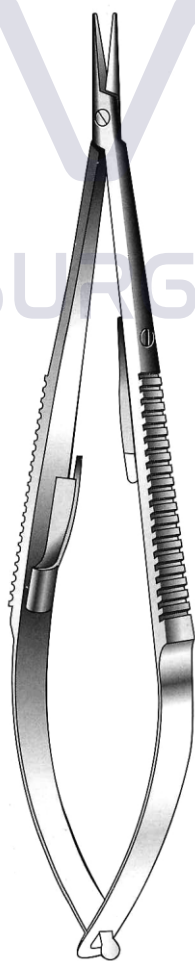

Castroviejo
With lock

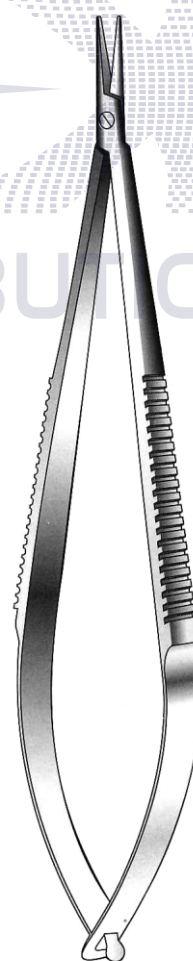

Castroviejo
Without lock

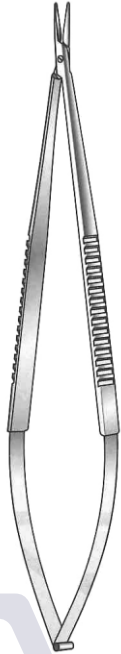

Castroviejo - Micro
 Without Lock
 Feather Light

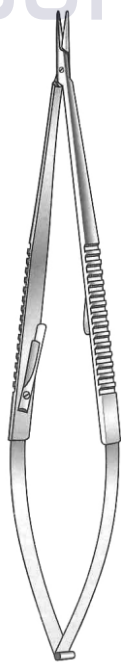
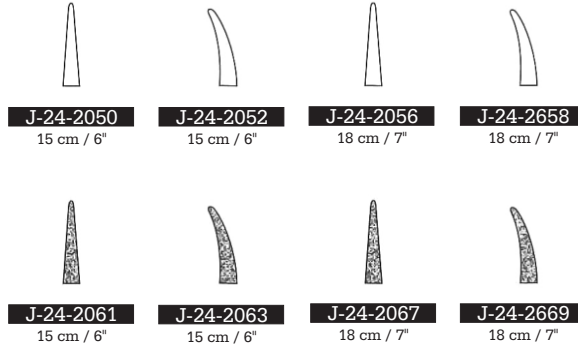

Castroviejo - Micro
 With Lock
 Feather Light

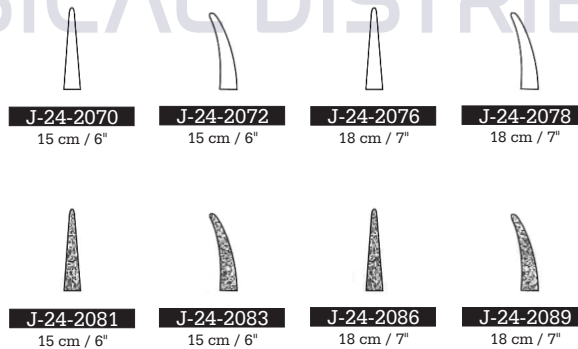



Barraquer
Without Lock



J-24-2090	13 cm / 5 1/8"
J-24-2091	15 cm / 6"
J-24-2092	18 cm / 7"
J-24-2093	21 cm / 9"
0.4 mm Tip	
J-24-2110	13 cm / 5 1/8"
J-24-2111	15 cm / 6"
J-24-2112	18 cm / 7"
J-24-2113	21 cm / 9"
0.5 mm Tip	

Standard



J-24-2100	
J-24-2101	
J-24-2102	
J-24-2103	
0.4 mm Tip	
J-24-2120	
J-24-2121	
J-24-2122	
J-24-2123	
0.5 mm Tip	



J-24-2130	13 cm / 5 1/8"
J-24-2131	15 cm / 6"
J-24-2132	18 cm / 7"
J-24-2133	21 cm / 9"
0.4 mm Tip	
J-24-2150	13 cm / 5 1/8"
J-24-2151	15 cm / 6"
J-24-2152	18 cm / 7"
J-24-2153	21 cm / 9"
0.5 mm Tip	

Serrated



J-24-2140	
J-24-2141	
J-24-2142	
J-24-2143	
0.4 mm Tip	
J-24-2160	
J-24-2161	
J-24-2162	
J-24-2163	
0.5 mm Tip	

MEDIX
SURGICAL DISTRIBUTION

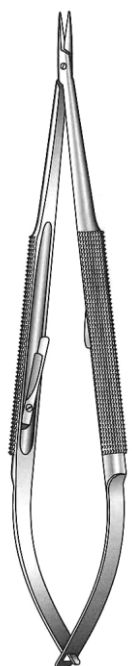

Barraquer
With Lock



J-24-2170	13 cm / 5 1/8"
J-24-2171	15 cm / 6"
J-24-2172	18 cm / 7"
J-24-2173	21 cm / 9"
0.4 mm Tip	
J-24-2190	13 cm / 5 1/8"
J-24-2191	15 cm / 6"
J-24-2192	18 cm / 7"
J-24-2193	21 cm / 9"
0.5 mm Tip	

Standard



J-24-2180	
J-24-2181	
J-24-2182	
J-24-2183	
0.4 mm Tip	
J-24-2200	
J-24-2201	
J-24-2202	
J-24-2203	
0.5 mm Tip	



J-24-2210	13 cm / 5 1/8"
J-24-2211	15 cm / 6"
J-24-2212	18 cm / 7"
J-24-2213	21 cm / 9"
0.4 mm Tip	
J-24-2230	13 cm / 5 1/8"
J-24-2231	15 cm / 6"
J-24-2232	18 cm / 7"
J-24-2233	21 cm / 9"
0.5 mm Tip	

Serrated



J-24-2220	
J-24-2221	
J-24-2222	
J-24-2223	
0.4 mm Tip	
J-24-2240	
J-24-2241	
J-24-2242	
J-24-2243	
0.5 mm Tip	



Barraquer
 Without Lock



J-24-2250
 J-24-2254
 13 cm / 5 1/4"



J-24-2270
 J-24-2274
 15 cm / 6"



J-24-2290
 J-24-2294
 18 cm / 7"



J-24-2312
 J-24-2314
 21 cm / 9"

0.4 mm Tip
 0.5 mm Tip



J-24-2260
 J-24-2264
 13 cm / 5 1/4"



J-24-2280
 J-24-2284
 15 cm / 6"



J-24-2302
 J-24-2304
 18 cm / 7"



J-24-2320
 J-24-2324
 21 cm / 9"

0.4 mm Tip
 0.5 mm Tip



Diamond Dust Jaws

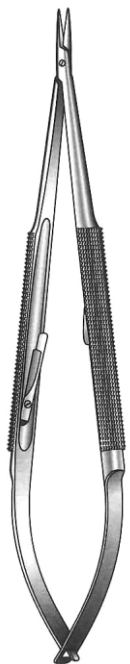

Barraquer
 With Lock



J-24-2330
 J-24-2334
 13 cm / 5 1/4"



J-24-2350
 J-24-2354
 15 cm / 6"



J-24-2370
 J-24-2374
 18 cm / 7"



J-24-2390
 J-24-2394
 21 cm / 9"

0.4 mm Tip
 0.5 mm Tip



J-24-2340
 J-24-2344
 13 cm / 5 1/4"



J-24-2360
 J-24-2364
 15 cm / 6"



J-24-2380
 J-24-2384
 18 cm / 7"



J-24-2401
 J-24-2404
 21 cm / 9"

0.4 mm Tip
 0.5 mm Tip



Diamond Dust Jaws



Without Lock
Titanium



- | | |
|-----------|------------|
| J-24-2410 | 15 cm / 6" |
| J-24-2414 | 18 cm / 7" |
| J-24-2418 | 21 cm / 9" |



- | | |
|-----------|------------|
| J-24-2420 | 15 cm / 6" |
| J-24-2424 | 18 cm / 7" |
| J-24-2428 | 21 cm / 9" |

Standard



- | | |
|-----------|------------|
| J-24-2430 | 15 cm / 6" |
| J-24-2434 | 18 cm / 7" |
| J-24-2438 | 21 cm / 9" |



- | | |
|-----------|------------|
| J-24-2440 | 15 cm / 6" |
| J-24-2444 | 18 cm / 7" |
| J-24-2448 | 21 cm / 9" |



Diamond Dust Jaw

MEDIX
SURGICAL DISTRIBUTION



With Lock
Titanium



- | | |
|-----------|------------|
| J-24-2450 | 15 cm / 6" |
| J-24-2454 | 18 cm / 7" |
| J-24-2458 | 21 cm / 9" |



- | | |
|-----------|------------|
| J-24-2460 | 15 cm / 6" |
| J-24-2464 | 18 cm / 7" |
| J-24-2468 | 21 cm / 9" |

Standard



- | | |
|-----------|------------|
| J-24-2470 | 15 cm / 6" |
| J-24-2474 | 18 cm / 7" |
| J-24-2478 | 21 cm / 9" |



- | | |
|-----------|------------|
| J-24-2480 | 15 cm / 6" |
| J-24-2484 | 18 cm / 7" |
| J-24-2488 | 21 cm / 9" |



Diamond Dust Jaw

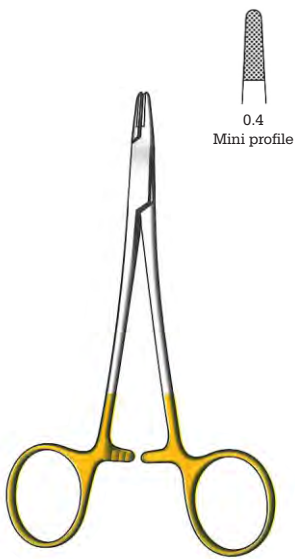

0.4
 Mini profile

Derf
JT-24-600
 12 cm / 4 3/4"



JT-24-601
 Smooth

Webster
 12 cm / 4 3/4"

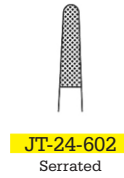

JT-24-602
 Serrated



JT-24-603
 Smooth

Webster
 12 cm / 4 3/4"
 Delicate

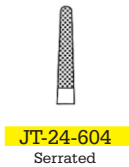

JT-24-604
 Serrated

MED 
 SURGICAL DISTRIBUTION



JT-24-606
 Smooth

Halsey
 13 cm / 5"

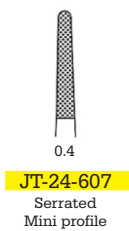

0.4
JT-24-607
 Serrated
 Mini profile

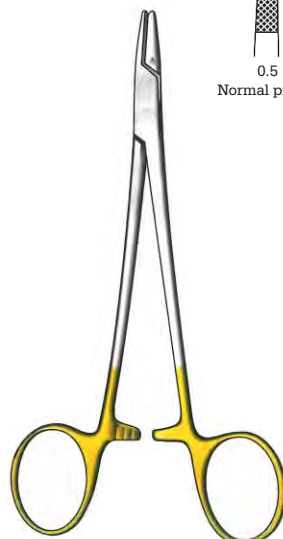

0.5
 Normal profile

Hegar-Baumgartner
JT-24-608 13 cm / 5 1/4"
JT-24-609 14 cm / 5 1/2"

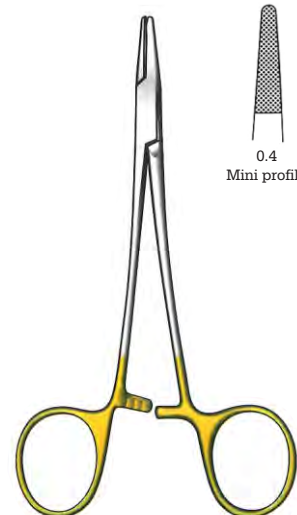

0.4
 Mini profile

With automatic release ratchet
JT-24-610 For right hand
JT-24-1220 For left hand
 13 cm / 5"

JT-24-611 For right hand
JT-24-1221 For left hand
 15 cm / 6"



SURGICAL DISTRIBUTION

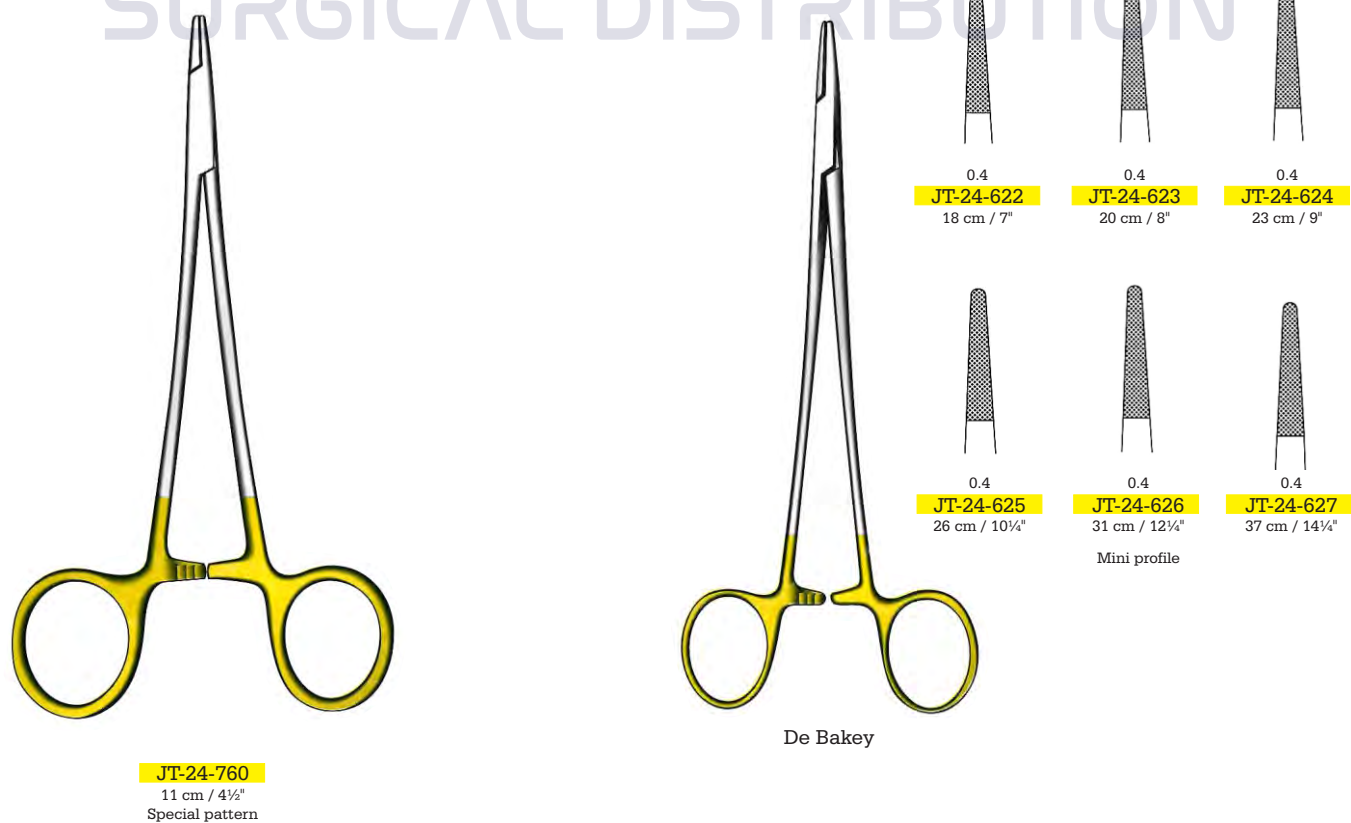

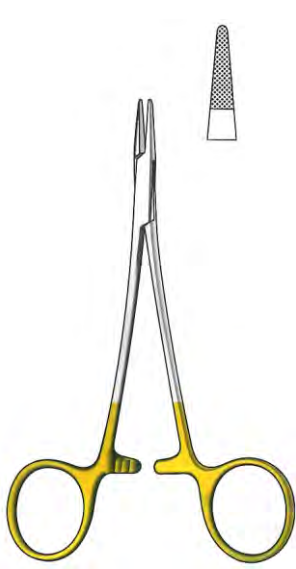

Gubisch
JT-24-1350
 12.5 cm / 5"

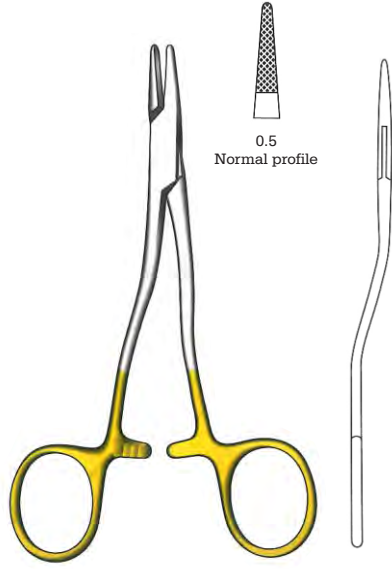

Kilner
JT-24-605
 13.5 cm / 5 1/4"

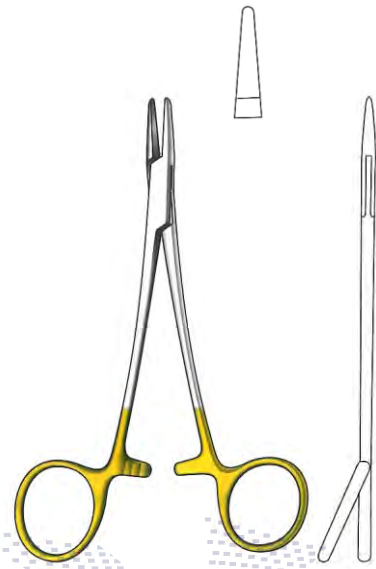

Neivert
JT-24-1360
 12.5 cm / 5"

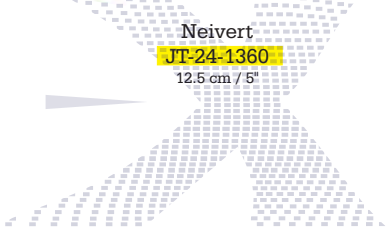
MED 
 SURGICAL DISTRIBUTION

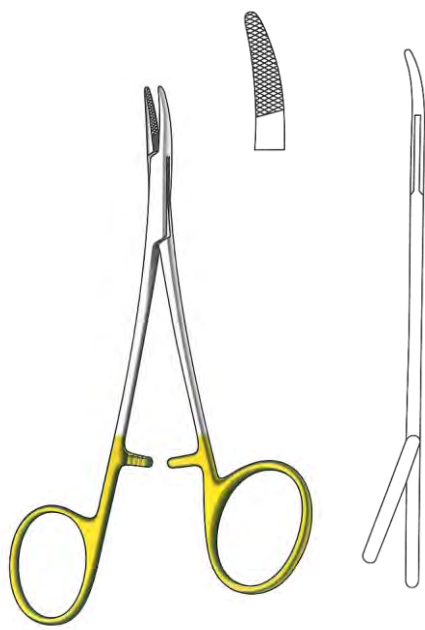

Converse
JT-24-1370
 15 cm / 6"

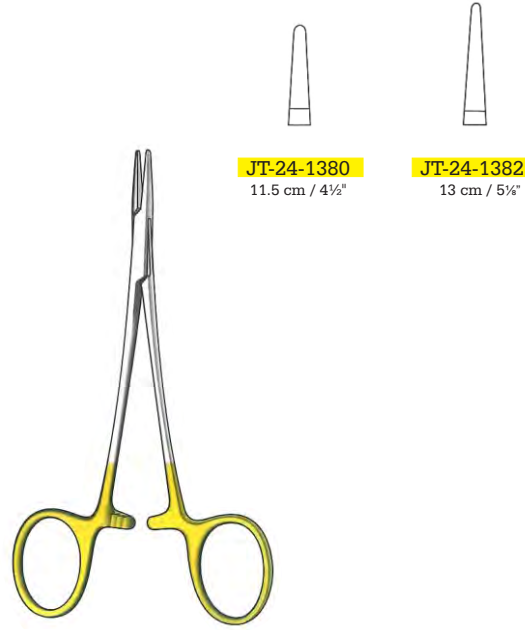

Nagata

JT-24-1380
 11.5 cm / 4 1/2"

JT-24-1382
 13 cm / 5 1/8"



SURGICAL DISTRIBUTION

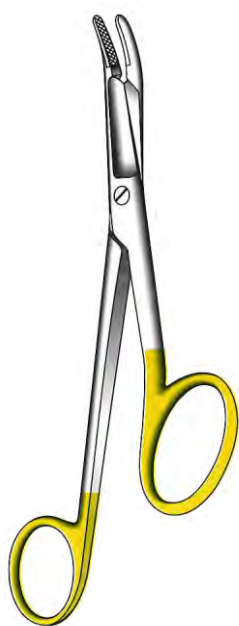

Gillies
With Scissors



- Gillies**
- JT-24-663 Right hand
 - JT-24-664 Left hand
 - 16 cm / 6 1/4"
 - Mini profile
- Mini Gillies**
Special model
- JT-24-665 Right hand
 - JT-24-666 Left hand
 - 12 cm / 4 3/4"
 - Mini profile
 - JT-24-790
 - 10 cm / 4"
 - Micro profile



Smooth jaws

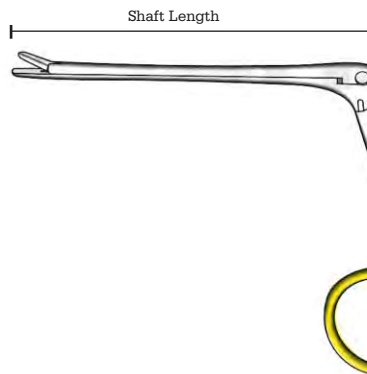

- Cottle-Masing**
- JT-24-1410 Shaft Length = 60 mm
 - JT-24-1412 Shaft Length = 90 mm
 - Mucosa needle holders



Mathieu
Standard

Mathieu

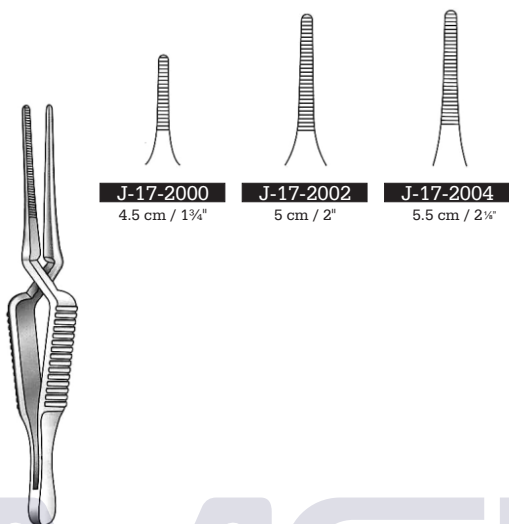

Diethrich
Bulldog Clamps

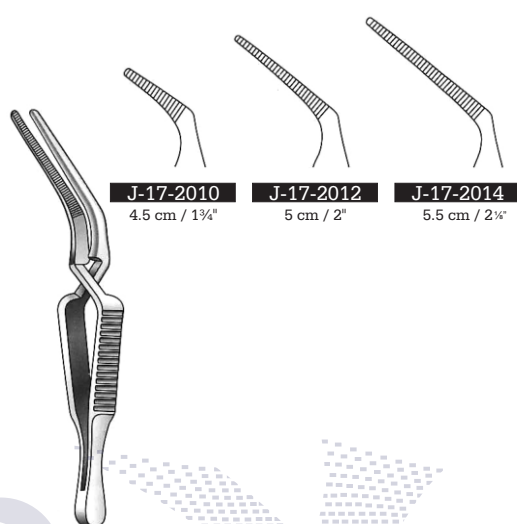

Diethrich
Bulldog Clamps

MEDIX
SURGICAL DISTRIBUTION

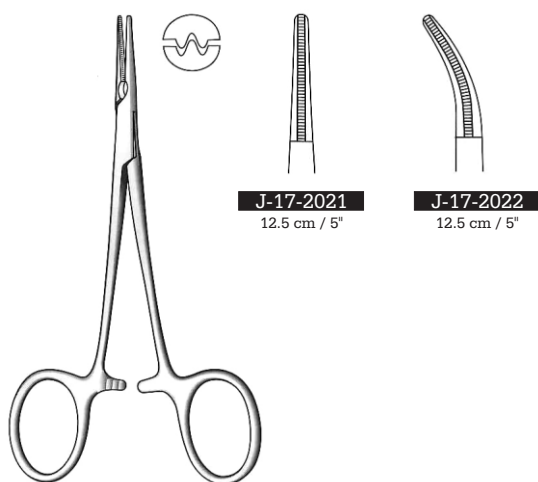

Mosquito
Atraumatic serration

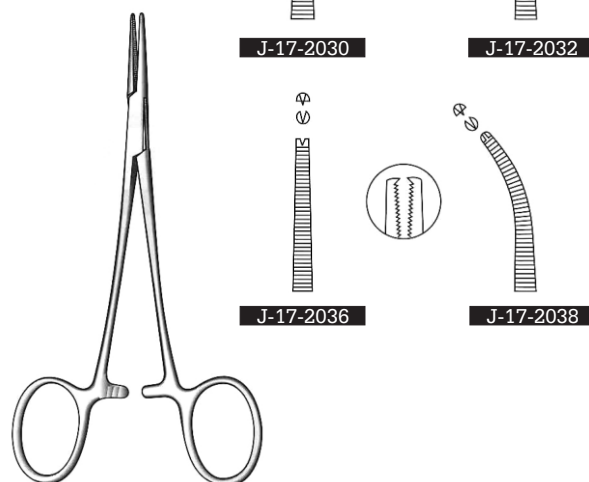

Micro-Halsted
12.5 cm / 5"
Extra Delicate

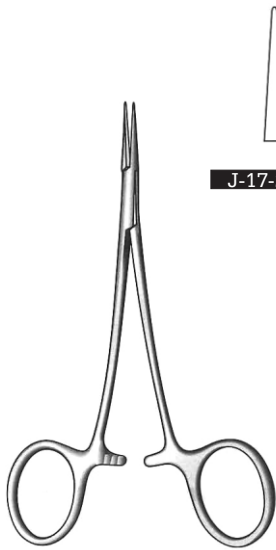

Micro-Jacobson
 12 cm / 5"
 Extra Delicate



J-17-2040



J-17-2042

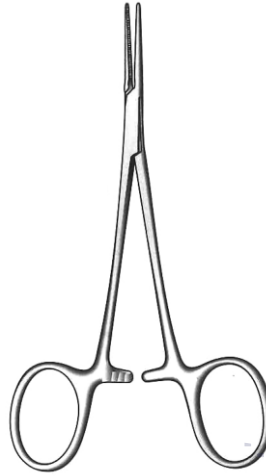

Micro-Mosquito
 Extra extra delicate



J-17-025
 10 cm / 4"



J-17-027
 10 cm / 4"



J-17-026
 12.5 cm / 5"



J-17-028
 12.5 cm / 5"



J-17-041
 Straight



J-17-042
 Curved



Normal
J-17-500 9 cm / 3½"
J-17-017 10 cm / 4"
J-17-502 12 cm / 4¾"
J-17-021 12.5 cm / 5"
J-17-033 18 cm / 7"
J-17-037 21 cm / 8¼"



Normal
J-17-506
J-17-018
J-17-508
J-17-022
J-17-034
J-17-038

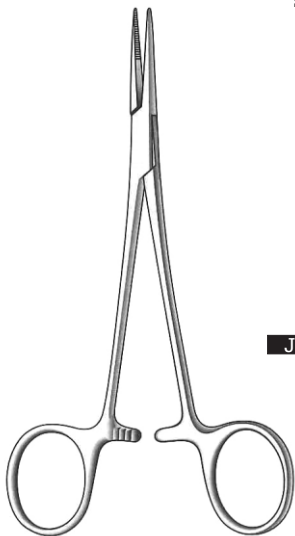

Providence-Hospital
 14 cm / 5½"
 Delicate



J-17-2060
 1:2 Teeth

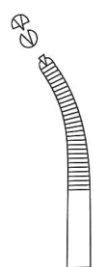

J-17-2062
 1:2 Teeth

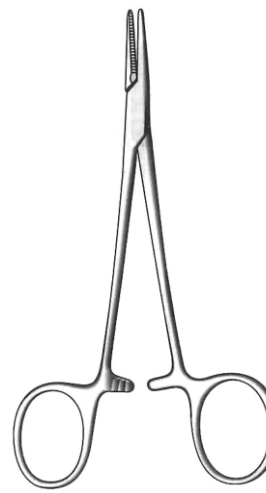

Halsted-Mosquito
 Normal



Normal
J-17-512 9 cm / 3½"
J-17-019 10 cm / 4"
J-17-514 12 cm / 4¾"
J-17-023 12.5 cm / 5"
J-17-035 18 cm / 7"
J-17-039 21 cm / 8¼"
 1:2 Teeth

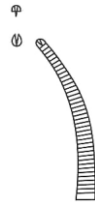

Normal
J-17-518
J-17-020
J-17-520
J-17-024
J-17-036
J-17-040
 1:2 Teeth

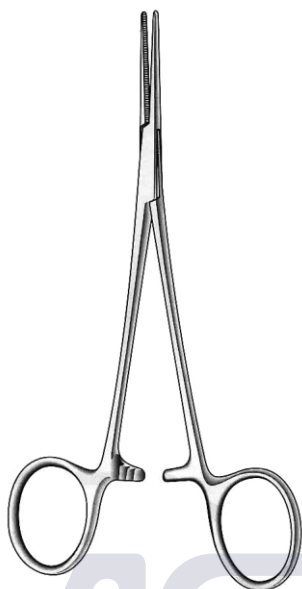

Leriche
15 cm / 6"



J-17-057



J-17-058

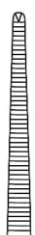

J-17-059
1.2 Teeth



J-17-060
1.2 Teeth

MEDIX
SURGICAL DISTRIBUTION

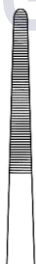

J-17-550

14 cm / 5½"

J-17-2070

16 cm / 6¼"

Straight

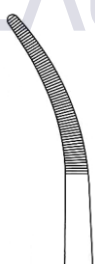

J-17-551

14 cm / 5½"

J-17-2072

16 cm / 6¼"

Curved

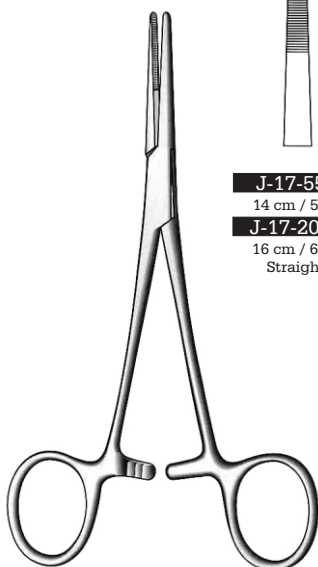

Kelly
Delicate



Crile
Delicate



J-17-560

14 cm / 5½"

J-17-2080

16 cm / 6¼"

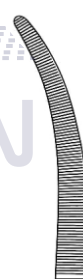

J-17-561

14 cm / 5½"

J-17-2082

16 cm / 6¼"



J-17-562

14 cm / 5½"

J-17-2086

16 cm / 6¼"

1.2 Teeth

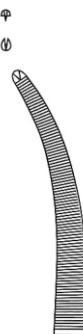

J-17-563

14 cm / 5½"

J-17-2088

16 cm / 6¼"

1.2 Teeth

ENT & Plastic Surgery
Instruments



Hand &
Foot Surgery

Hand & Foot Surgery

Hand & Foot Surgery



Bone Hook
J-32-5004 Sharp
J-32-5005 Blunt
 15 cm / 5 3/4"
 1 Prong, Round Handle

Senn Muller Hook
J-32-5010
 15 cm / 5 3/4"
 8 mm Curved, 11 mm wide
 3-Prong, Sharp
 Round Handle

Senn Muller Hook
J-32-5021
 15 cm / 5 3/4"
 8 mm Curved, 11 mm wide
 3-Prong, Blunt
 Round Handle

Senn Muller Hook
J-32-5031 Sharp
J-32-5032 Blunt
 15 cm / 5 3/4"
 2 Prong, Round Handle

Joseph Hook
J-32-5041 3 mm, 3 mm
J-32-5042 6 mm, 4 mm
J-32-5043 5 mm, 8 mm
 Curved, Wide
 15 cm / 5 3/4"
 2 Prong, Sharp
 Round Handle



Meyerding Retractor

- J-32-5051** 6 x 4 mm
- J-32-5052** 10 x 4 mm
- 15 cm / 5 3/4"
- Round Handle

Meyerding Retractor

- J-32-5061** 4 x 4 mm
- J-32-5062** 6 x 4 mm
- 15 cm / 5 3/4"
- Round Handle

Langenbeck Retractor

- J-32-5071** 10 x 6 mm
- J-32-5072** 11 x 4 mm
- J-32-5073** 12 x 8 mm
- 15 cm / 5 3/4"
- Round Handle

Cushing Retractor

- J-32-5081** 6 mm
- J-32-5082** 8 mm
- J-32-5083** 10 mm
- J-32-5084** 12 mm
- Rigid
- Round Handle

Hohmann Retractor

- J-32-5094** 4 mm
- J-32-5095** 5 mm
- J-32-5096** 6 mm
- J-32-5097** 7 mm
- J-32-5098** 8 mm
- 15 cm / 5 3/4"
- Round Handle



Scalpel Handle
J-32-5101
15 cm / 5 3/4"
Straight
Round Handle

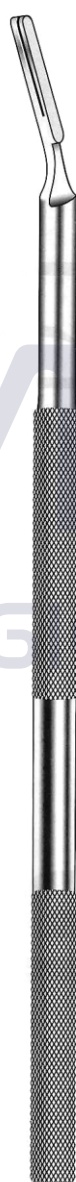

Scalpel Handle
J-32-5111
15 cm / 5 3/4"
Angled
Round Handle



Periosteal Elevator
J-32-5122 2 mm
J-32-5123 3 mm
J-32-5124 4 mm
J-32-5125 5 mm
J-32-5126 6 mm
J-32-5127 7 mm
J-32-5128 8 mm
15 cm / 5 3/4"
Round Handle, Slight Curved



Bone Level Elevator
J-32-5133
15 cm / 5 3/4"
3 mm
Curved to the Side
Round Handle



Bone Level Elevator
J-32-5143
15 cm / 5 3/4"
3 mm
Curved up
Round Handle



Osteotomes

J-32-5152	2 mm
J-32-5153	3 mm
J-32-5154	4 mm
J-32-5155	5 mm
J-32-5156	6 mm
J-32-5157	7 mm
J-32-5158	8 mm
15 cm / 5 3/4" Round Handle	



Gouge

J-32-5164	4 mm
J-32-5166	6 mm
J-32-5167	7 mm
J-32-5168	8 mm
J-32-5170	10 mm
J-32-5172	12 mm
15 cm / 5 3/4" Round Handle	



Chisel

J-32-5182	2 mm
J-32-5183	3 mm
J-32-5184	4 mm
J-32-5185	5 mm
J-32-5186	6 mm
J-32-5187	7 mm
J-32-5188	8 mm
15 cm / 5 3/4" Round Handle	



Bone File

J-32-5203	3 mm
J-32-5204	4 mm
J-32-5205	5 mm
J-32-5206	6 mm
J-32-5207	7 mm
J-32-5208	8 mm
J-32-5210	10 mm
J-32-5212	12 mm
15 cm / 5 3/4" Round Handle	



Bone File

J-32-5222	Coarse
J-32-5224	Fine
6 mm, 15 cm / 5 3/4" Round Handle	

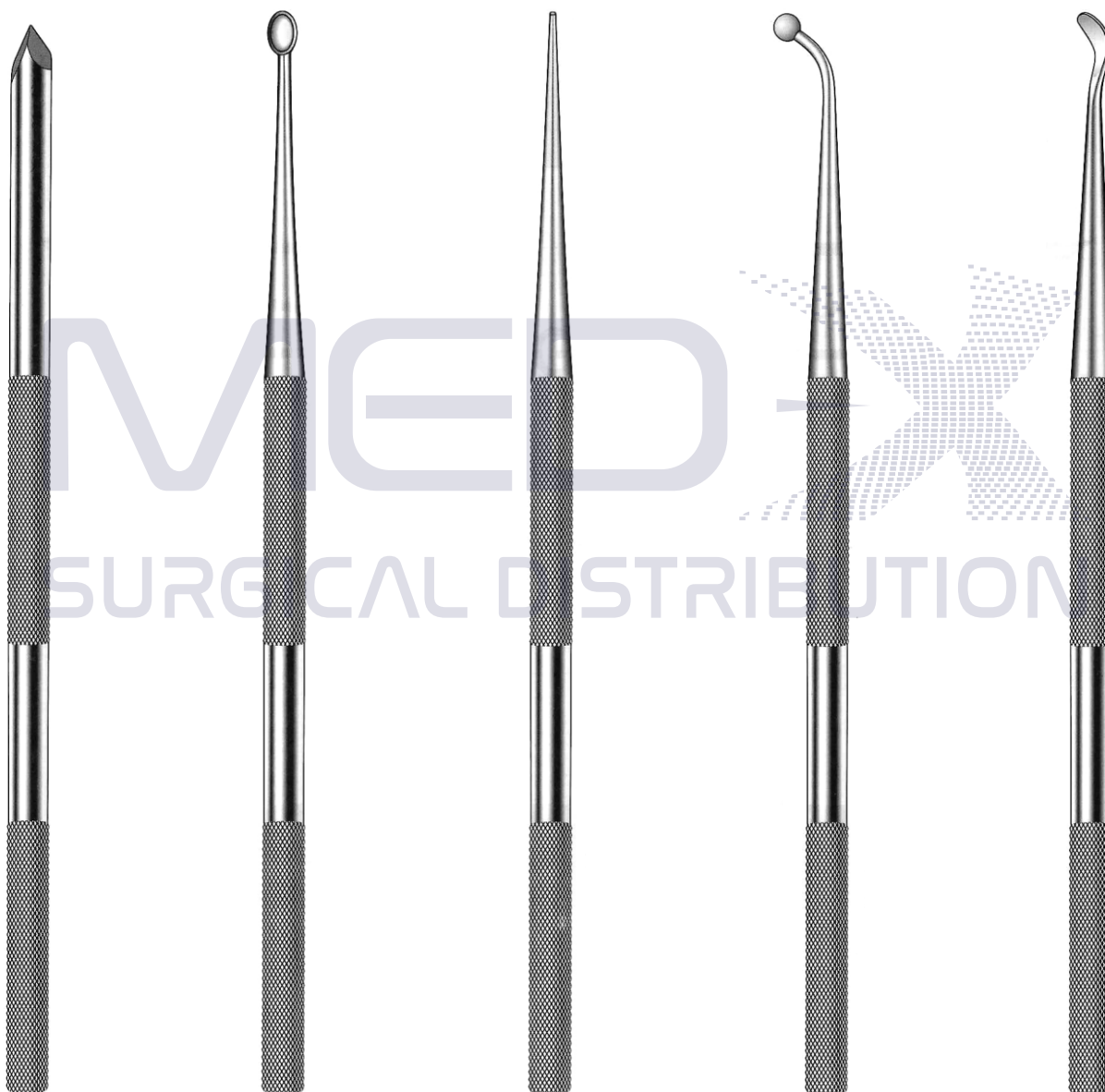

Bone Awl

- J-32-5232** 2.5 mm
- J-32-5235** 5 mm
- 15 cm / 5¾"
- Round Handle

Bone Curettes

- J-32-5241** 1 mm
- J-32-5242** 2 mm
- J-32-5243** 3 mm
- J-32-5244** 4 mm
- J-32-5245** 5 mm
- 15 cm / 5¾"
- Round Handle, cup size

Bone Tamper

- J-32-5251** 1 mm
- J-32-5252** 2 mm
- J-32-5253** 3 mm
- J-32-5254** 4 mm
- J-32-5255** 5 mm
- 15 cm / 5¾"
- Round Handle

Bone Packer

- J-32-5262** 2 mm
- J-32-5263** 3 mm
- J-32-5264** 4 mm
- J-32-5265** 5 mm
- 15 cm / 5¾"
- Ball Tip
- Round Handle

Miller Colburn Curattes

- J-32-5272** 2 mm
- J-32-5273** 3 mm
- J-32-5274** 4 mm
- J-32-5275** 5 mm
- 15 cm / 5¾"
- Round Handle

ENT & Plastic Surgery
Instruments



Delicate Retractors

Delicate Retractors

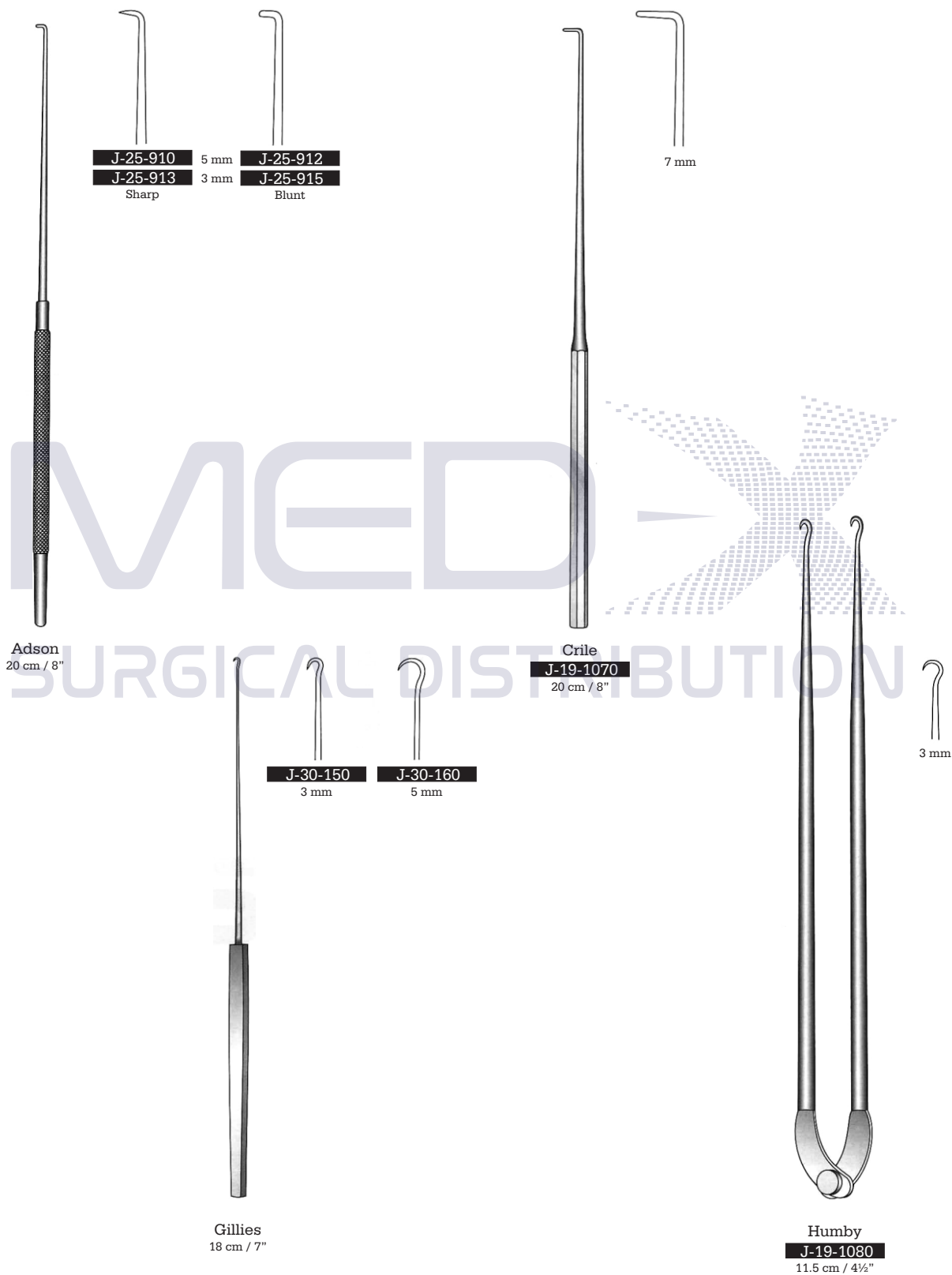

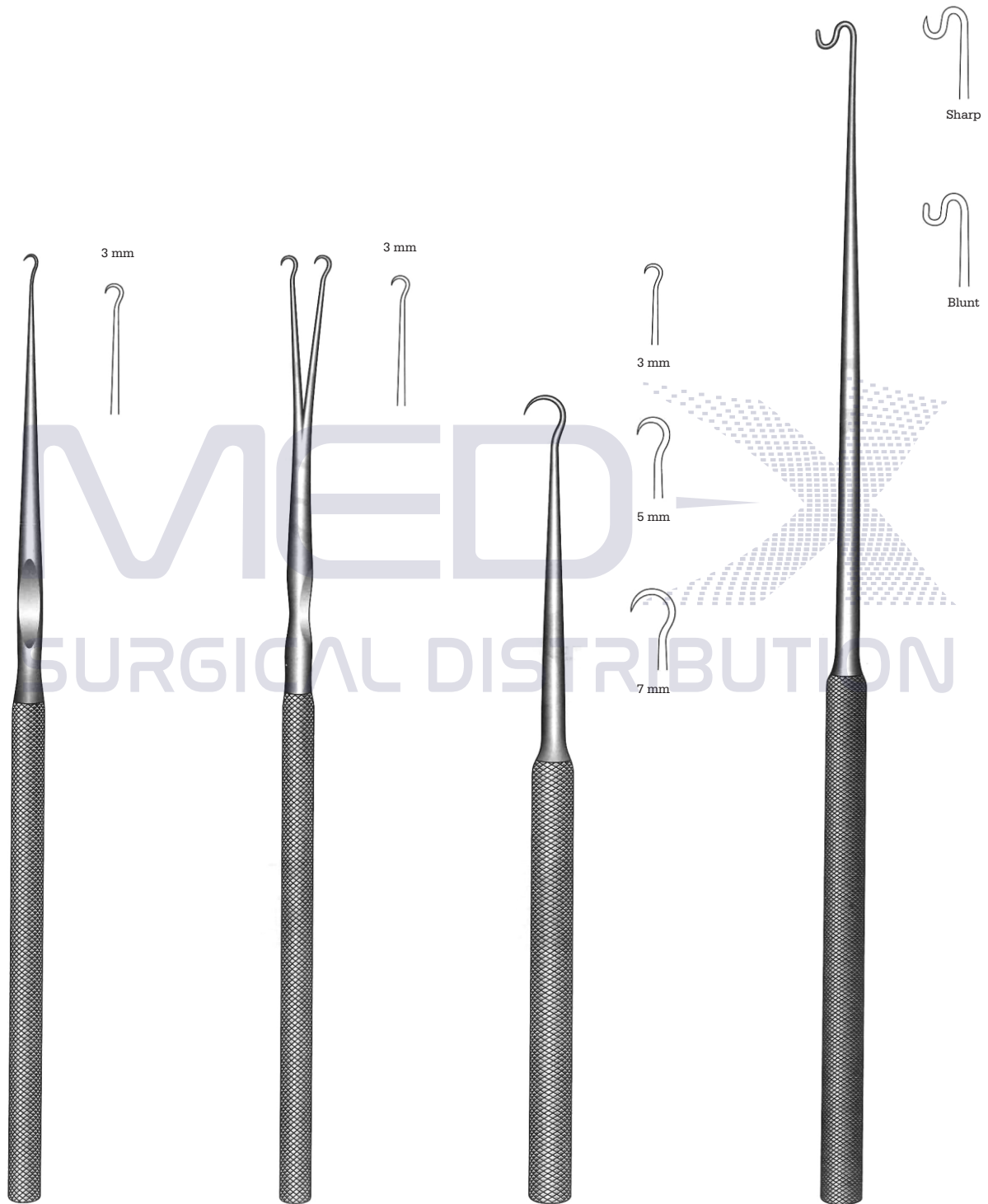

Barsky
J-19-1090
 15 cm / 6"
 Skin Hook

Barsky
J-19-1100
 15 cm / 6"
 Skin Hook

Kleinert-Kutz
J-19-1110 3 mm
J-19-1112 5 mm
J-19-1114 7 mm
 13 cm / 5 1/8"
 Skin Hook

Benicke
J-19-1120 Sharp
J-19-1122 Blunt
 19 cm / 7 1/2"
 Skin Hook

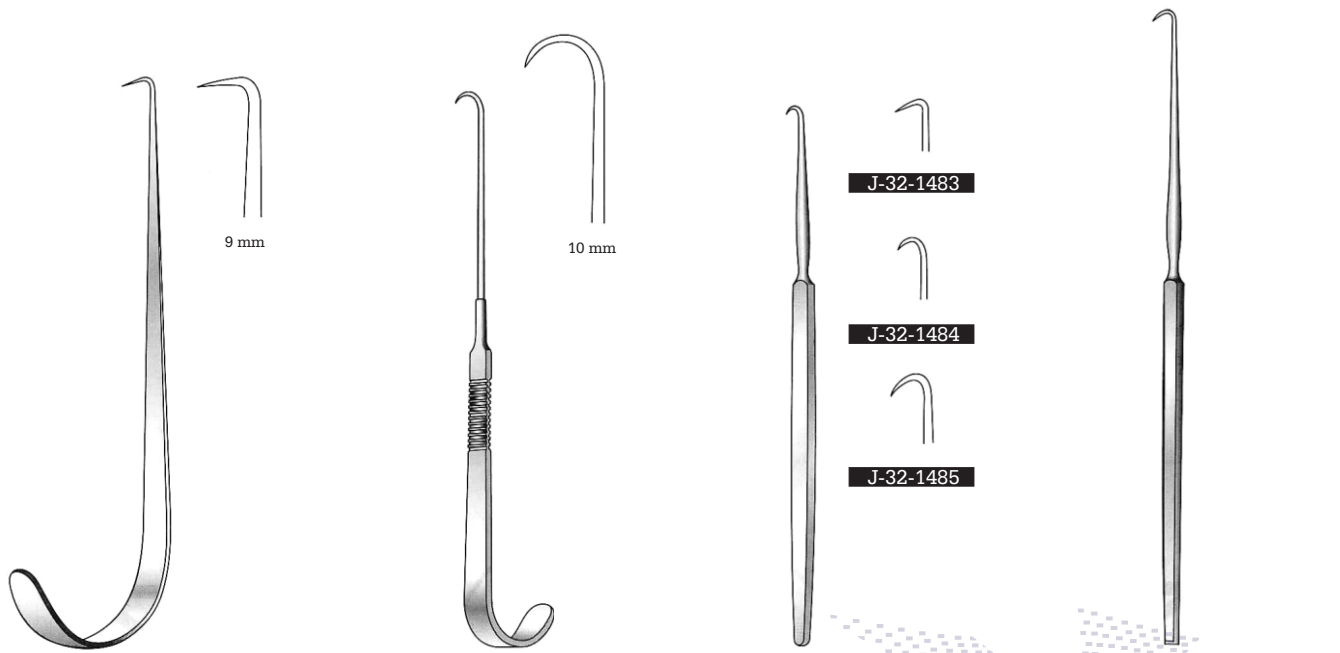

Jackson
J-26-110
15 cm / 6"
Tracheal hooks

News
J-26-110A
15 cm / 6"

Cottle
15 cm / 6"

Cottle
J-32-1482
16 cm / 6¼"
Sharp

MEDICAL SURGICAL DISTRIBUTION

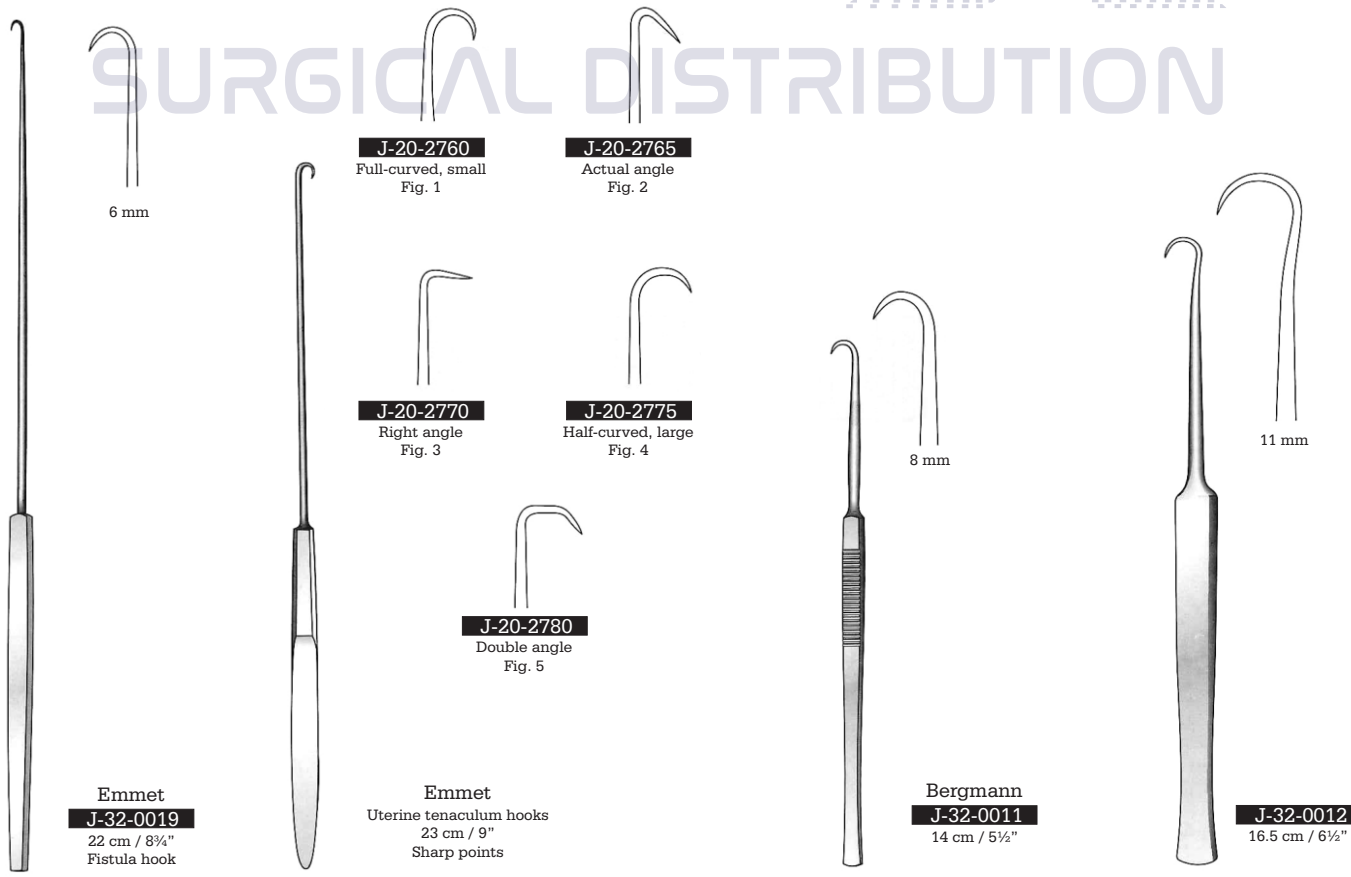

Emmet
J-32-0019
22 cm / 8¾"
Fistula hook

Emmet
Uterine tenaculum hooks
23 cm / 9"
Sharp points

Bergmann
J-32-0011
14 cm / 5½"

J-32-0012
16.5 cm / 6½"

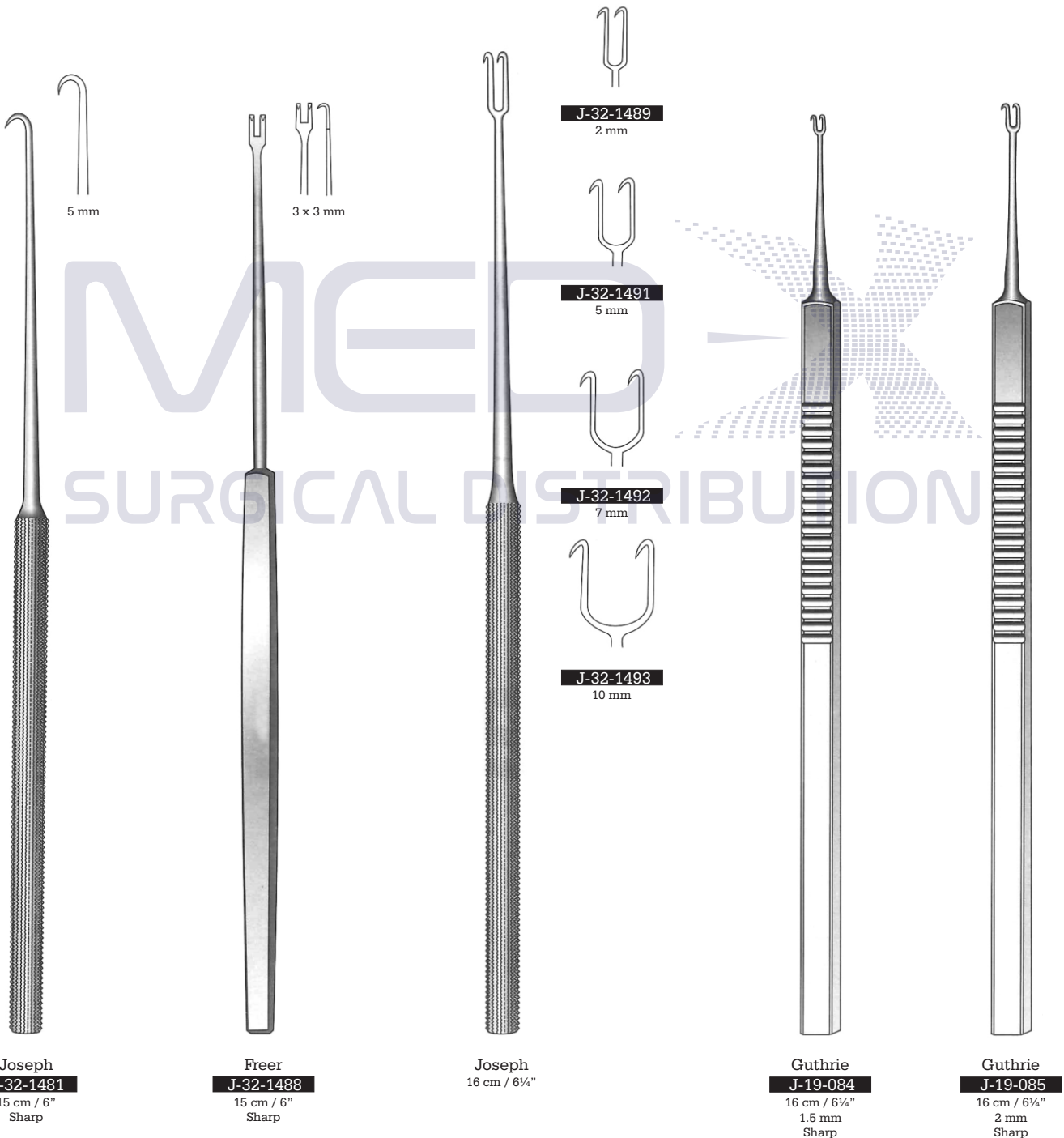

Joseph
J-32-1481
 15 cm / 6"
 Sharp

Freer
J-32-1488
 15 cm / 6"
 Sharp

Joseph
 16 cm / 6 1/4"

Guthrie
J-19-084
 16 cm / 6 1/4"
 1.5 mm
 Sharp

Guthrie
J-19-085
 16 cm / 6 1/4"
 2 mm
 Sharp

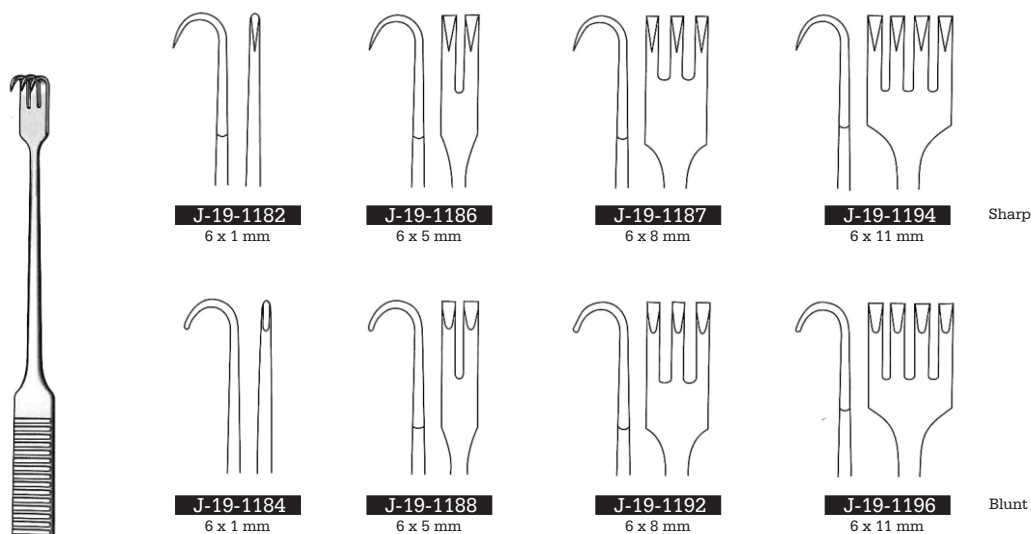

Jacobson
17 cm / 6 3/4"

MED X
SURGICAL DISTRIBUTION

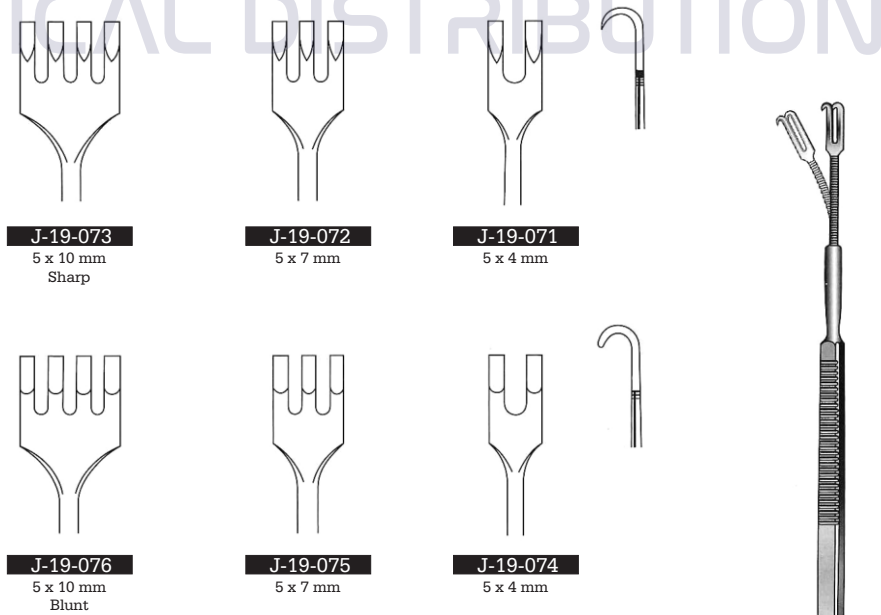

16 cm / 6 1/4"
Flexible Hook

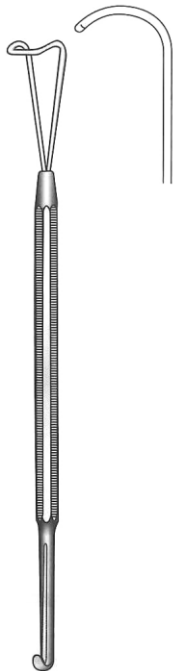

Neivert
J-32-1597
 16 cm / 6¼"

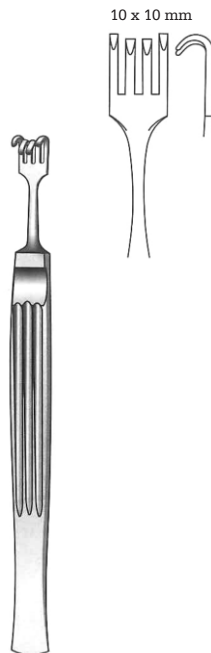

Cottle
J-32-1596
 14 cm / 5½"
 Alar hooklets



Aufricht
J-32-1601
 13.5 cm / 5¼"
 60 x 6.5 mm blade
 Blunt

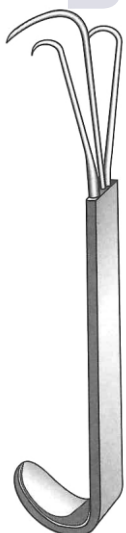

Becker
J-32-3400 Small
J-32-3401 Medium
J-32-3402 Large
J-32-3403 X-Large
 12 cm / 4¾"
 Plastic surgery, american made
 open retractors

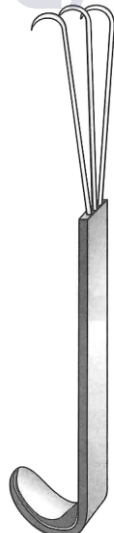

Anderson
 Three prong
J-32-3410
 12 cm / 4¾"
 Short
J-32-3412
 16 cm / 6¼"
 Long
 Plastic surgery, american
 made retractor

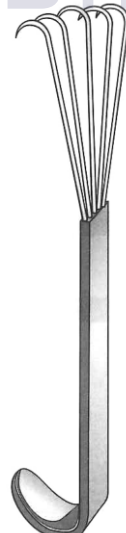

Anderson
 Five prong
J-32-3411
 12 cm / 4¾"
 Short
J-32-3413
 16 cm / 6¼"
 Long
 Plastic surgery, american
 made retractor



Aufricht
J-33-1390
 11 cm / 4¼"
 50 x 6 mm

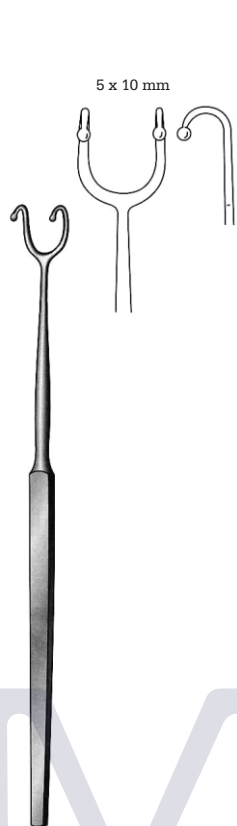

Fomon
J-32-1494
16 cm / 6 1/4"

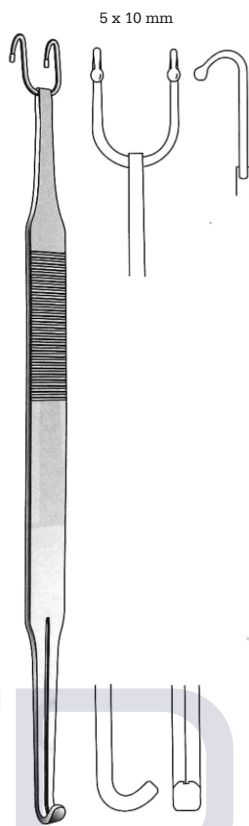

Cottle-Neivert
J-32-5301
20 cm / 8"
With Guide Channel

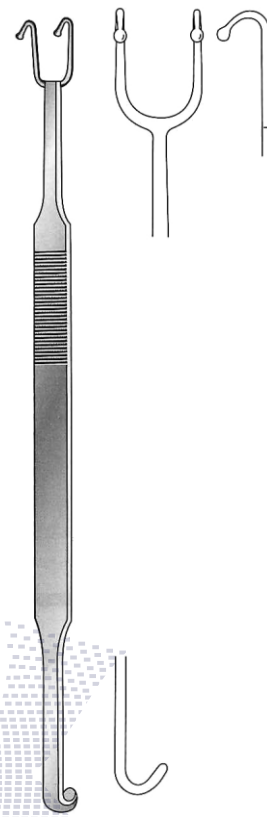

Cottle-Neivert
J-32-1495
20 cm / 8"

MEDIX
SURGICAL DISTRIBUTION

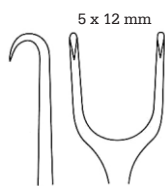

Millard (Cottle)
J-32-5490
5.5 cm / 2 1/8"
With finger ring

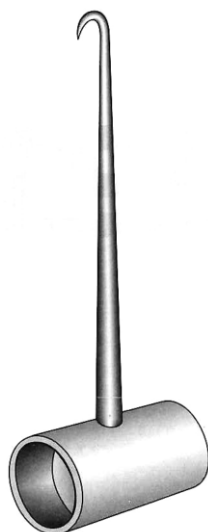

Weighted Nasal Hook
J-30-320
Approx. weight, 2oz
Nasal hook

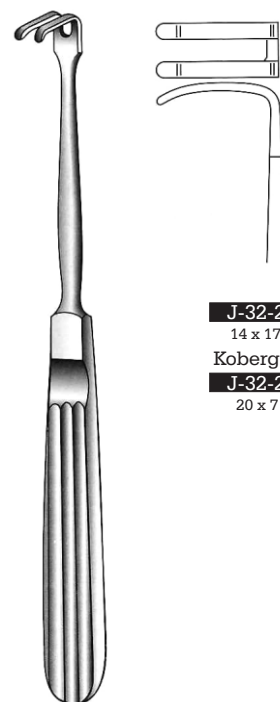

J-32-2670
14 x 17 mm
Koberg. mod
J-32-2671
20 x 7 mm

18.5 cm / 7 1/4"

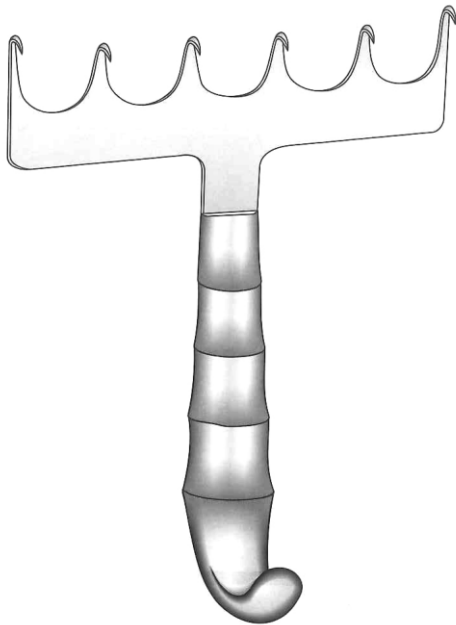

Yancoskie Abdominoplasty

Retractor

J-19-1200
6 Sharp Prongs
Wide: 15 cm / 6"
Long: 18 cm / 7"

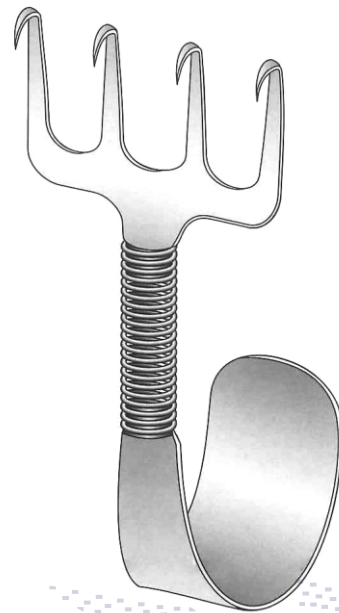

Gorney Rake Retractor

J-19-1210

Spring Neck
4 Sharp Prongs
1.5" wide
7.5 cm / 3"

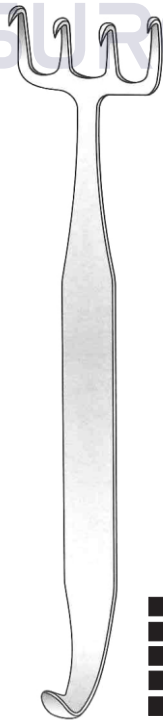

Freeman Rake Retractor

J-19-1220 4 Sharp Prongs, 1.5" wide: 10 cm/4in
J-19-1222 4 Blunt Prongs, 0.75" wide: 18 cm/7in
J-19-1224 4 Sharp Prongs, 1.5" wide: 18 cm/7in
J-19-1226 4 Sharp Prongs, 0.875" wide: 18 cm/7in
J-19-1228 4 Sharp Prongs, 1" wide: 11 cm/4.25in

Freeman Mini Rake Retractor

J-19-1230 4 Sharp Prongs, with Thumb Ring, 0.75" wide: 5cm/2in

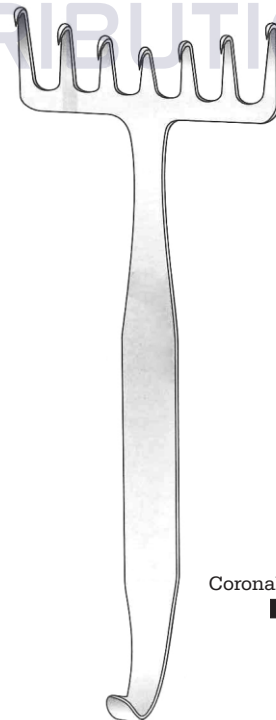

Coronal Brow Lift Retractor

J-19-1240
7 Sharp Prongs
2.75" wide
18 cm / 7"

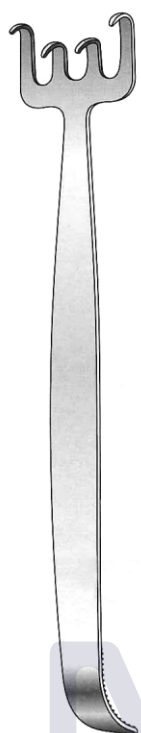

Walter
J-19-1245
19 cm / 7½"
Facelift

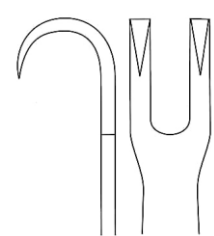
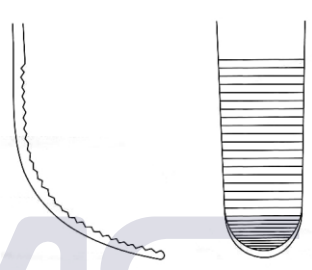
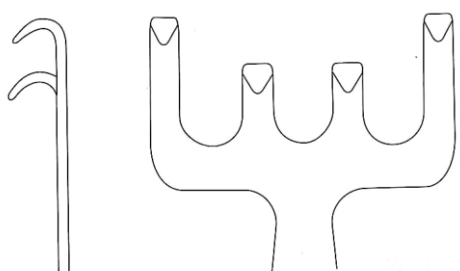

Kilner
J-32-1486
10 cm / 4"
Sharp

SURGICAL DISTRIBUTION

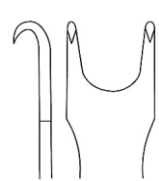

5 x 10 mm



Gubisch-Kilner
J-32-5480
8 cm / 3¼"



7 x 10 mm



Converse
J-32-1487
12 cm / 4¾"
Double ended
Sharp

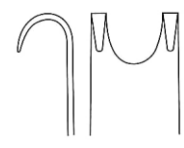

7 x 10 mm

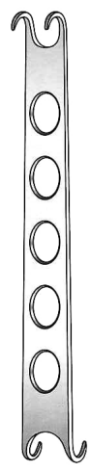

Converse
J-32-5485
12 cm / 4¾"
Double ended
Blunt

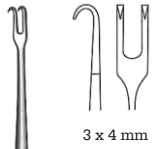

3 x 4 mm

Cottle
J-32-5475
 15 cm / 6"
 Alar Retractor



Cottle
 15 cm / 6"



J-32-1496
 Sharp / Sharp



J-32-1497
 Blunt / Sharp



J-32-1498
 Sharp / Blunt

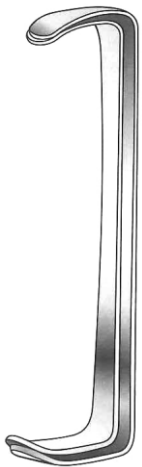

Farabeuf-Baby
J-19-001
 12 cm / 4 3/4"
 Set of 2

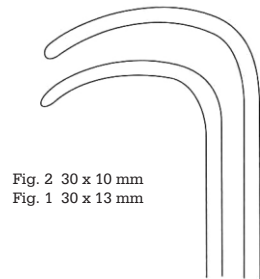

Fig. 2 30 x 10 mm
 Fig. 1 30 x 13 mm

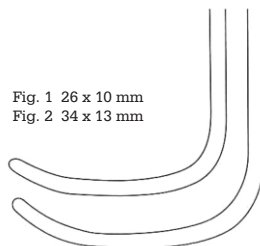

Fig. 1 26 x 10 mm
 Fig. 2 34 x 13 mm



Farabeuf
J-19-002
 15 cm / 6"
 Set of 2

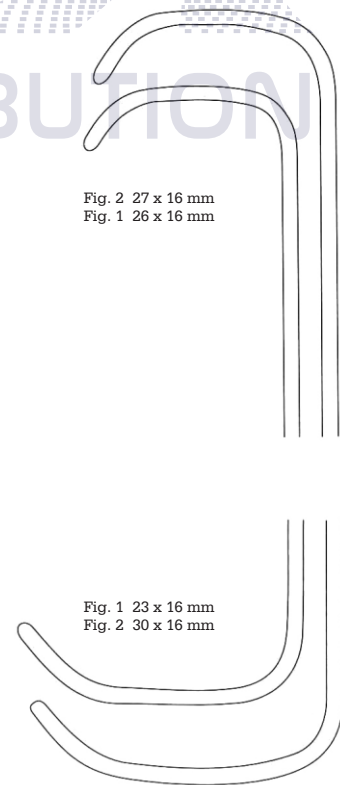
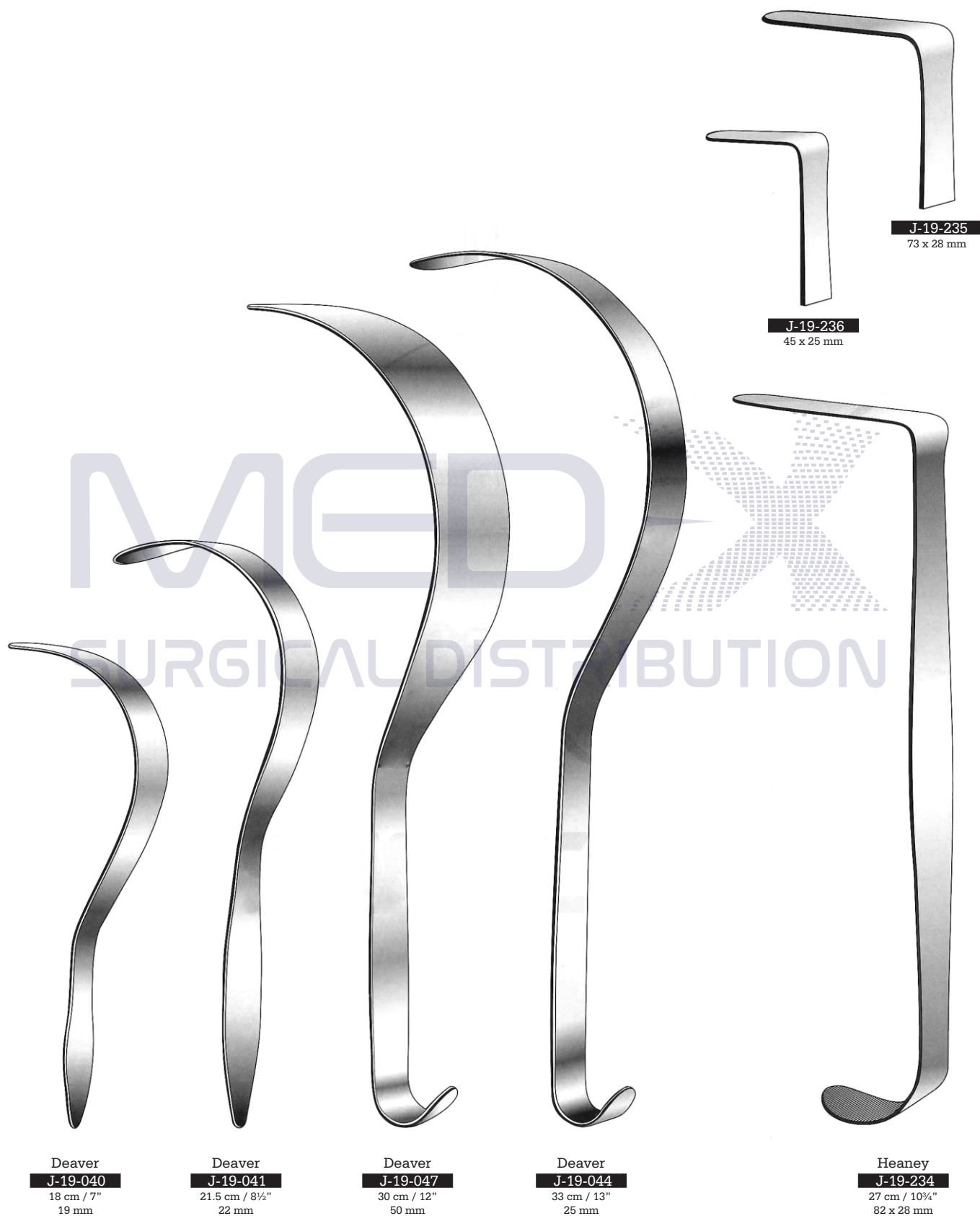
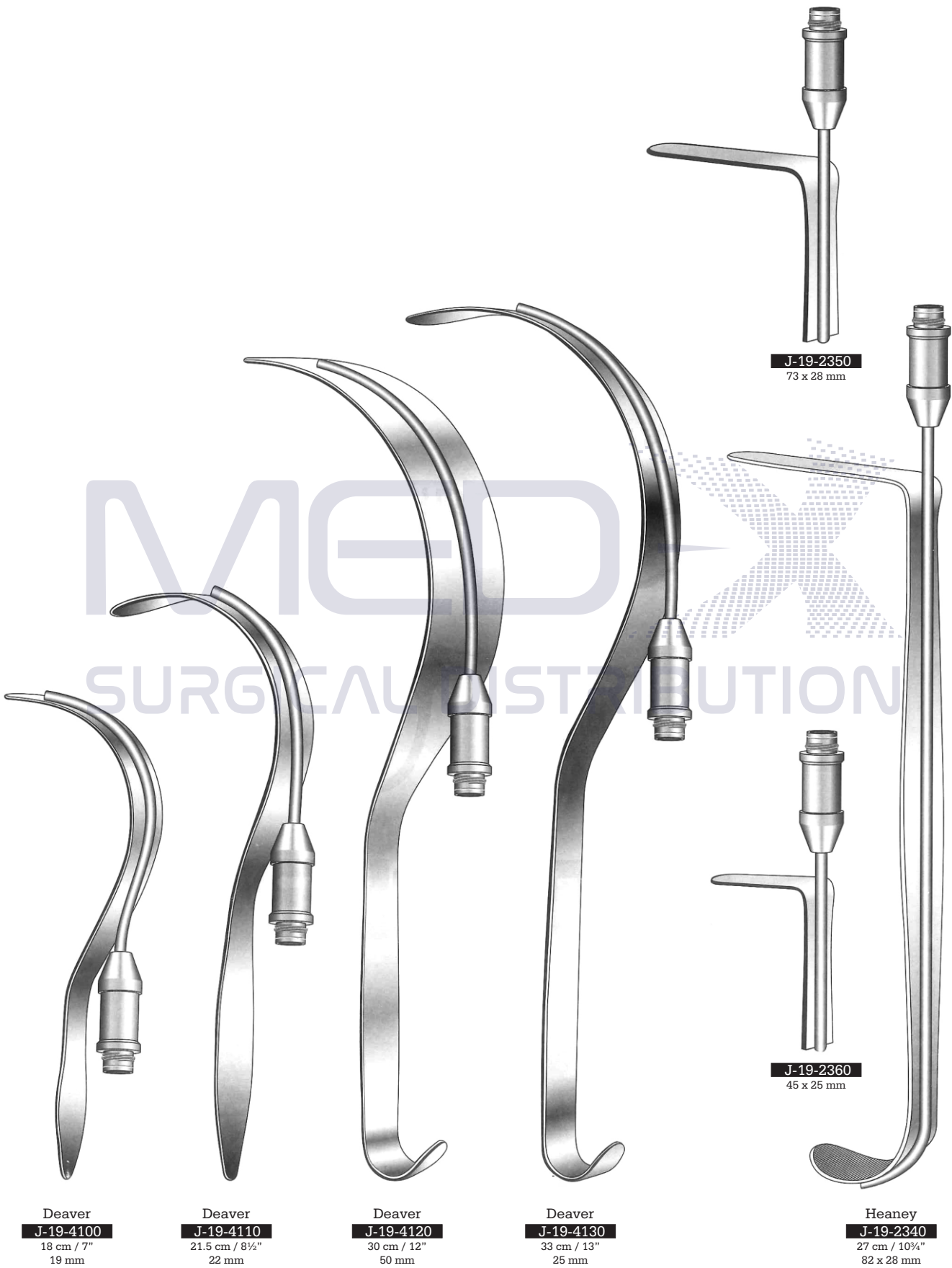
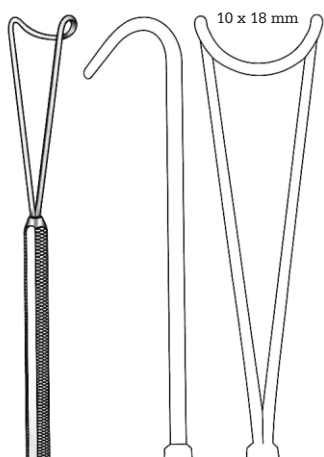

Fig. 2 27 x 16 mm
 Fig. 1 26 x 16 mm

Fig. 1 23 x 16 mm
 Fig. 2 30 x 16 mm







Masing
J-32-5495
20 cm / 8"
Alar Retractor

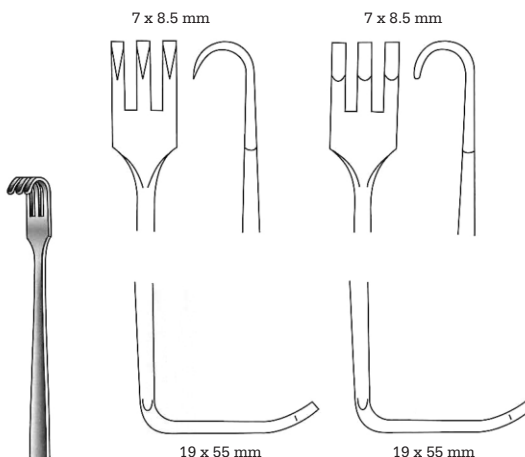

J-19-117
Sharp

J-19-118
Blunt

Senn-Miller
16 cm / 6¼"



Ragnell-Davis
J-19-114
14 cm / 5½"

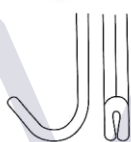

Cope-Walter
J-19-1140
17.5 cm / 7"
Nasal Retractors

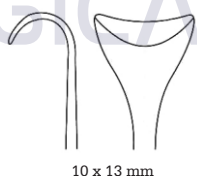

10 x 13 mm

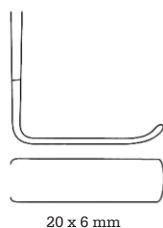

20 x 6 mm

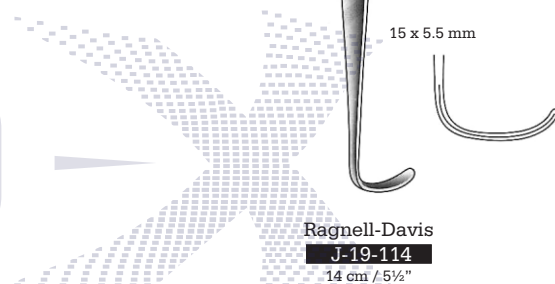

15 x 5.5 mm



6 x 8 mm

Jackson
J-26-140
17 cm / 6¾"



10 x 12 mm

SURGICAL DISTRIBUTION

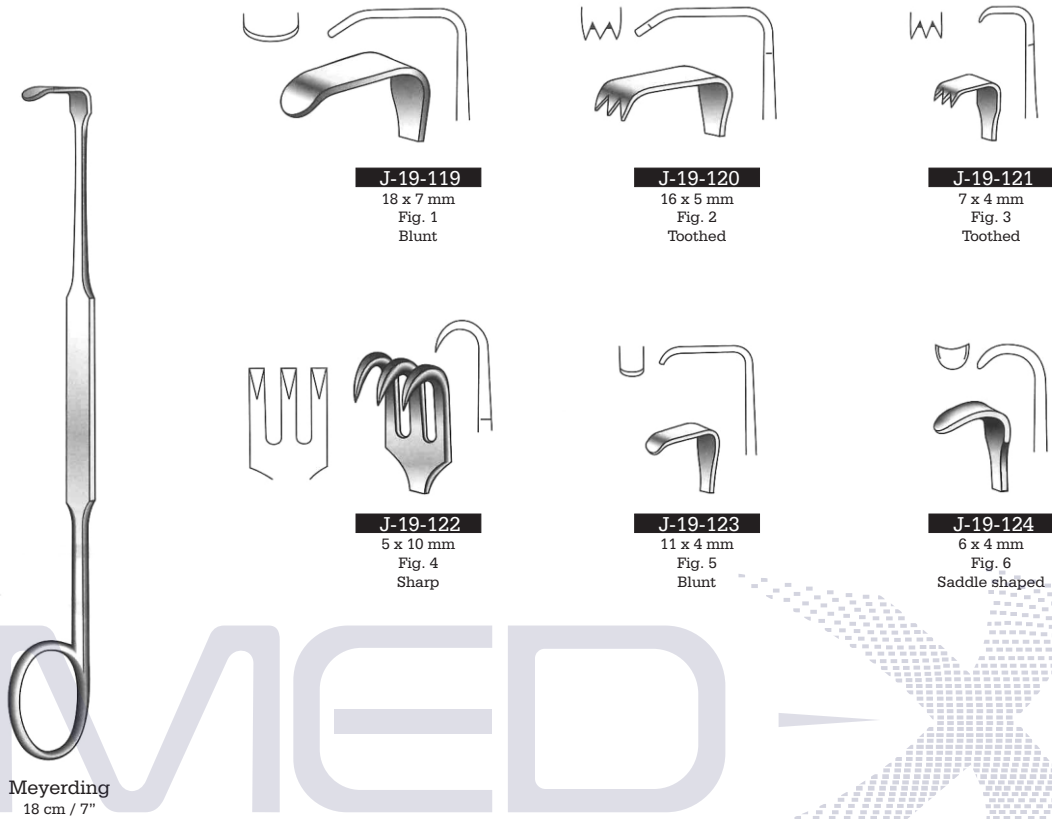

SURGICAL DISTRIBUTION

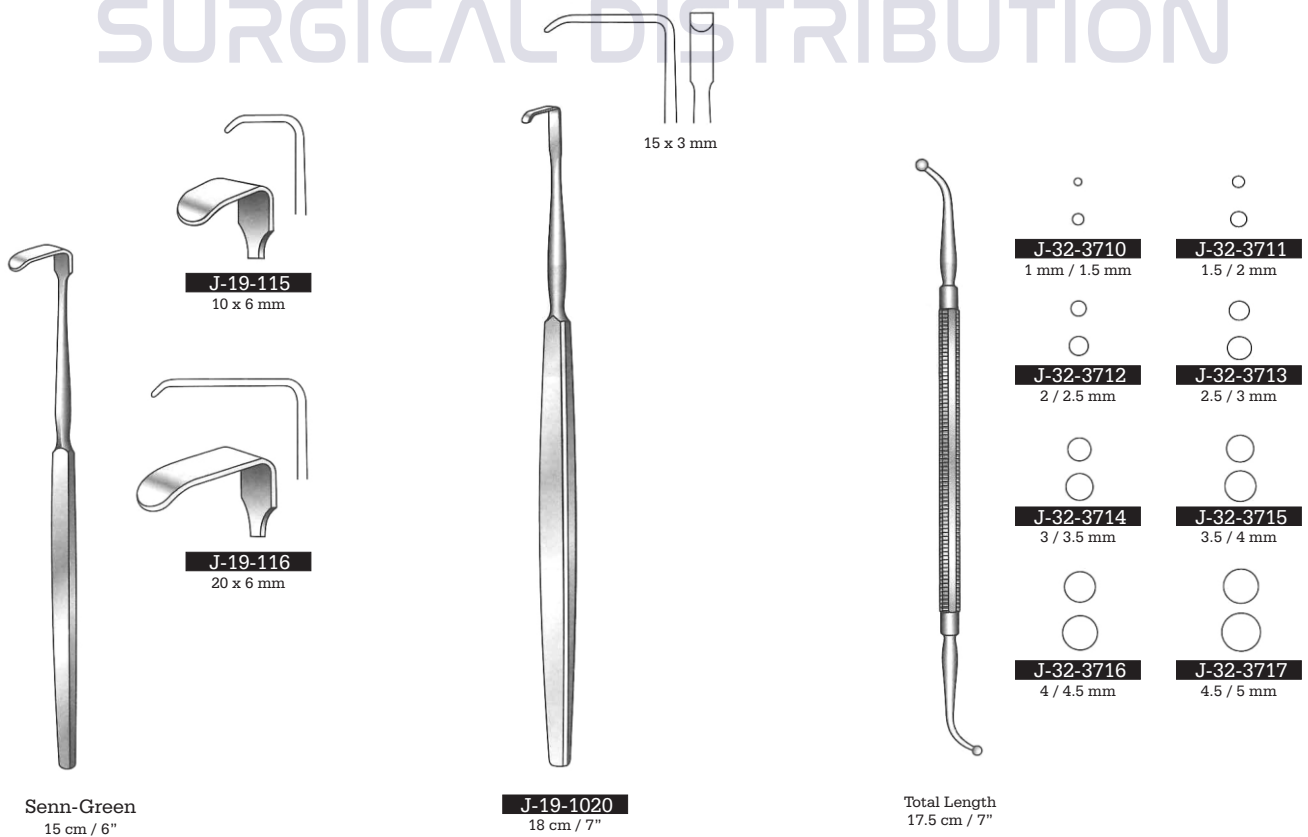

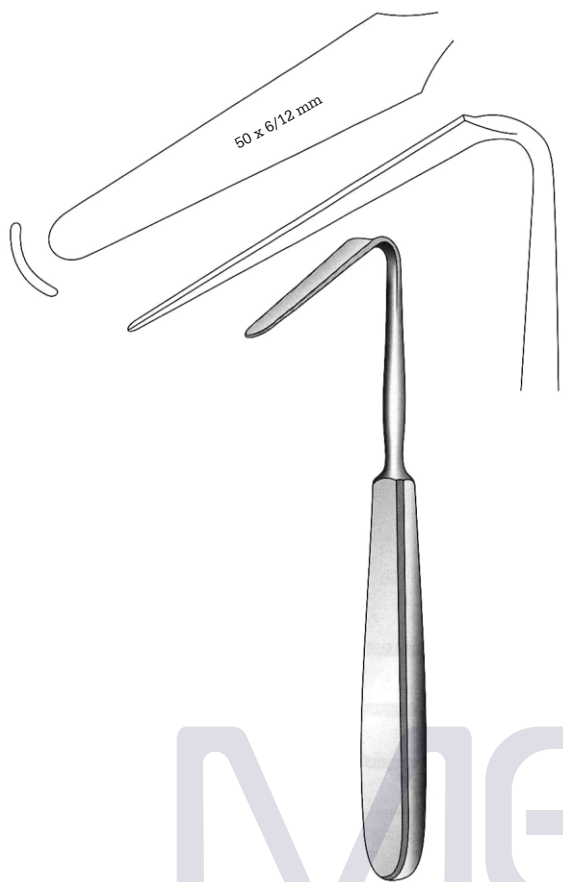

Gubisch-Aufricht
J-33-807
17 cm / 6 3/4"

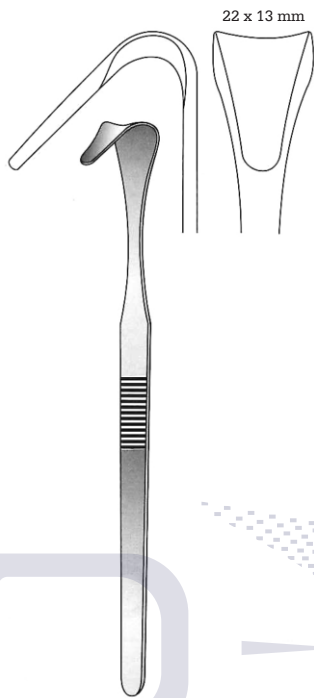

Cottle
J-32-1599
15 cm / 6"

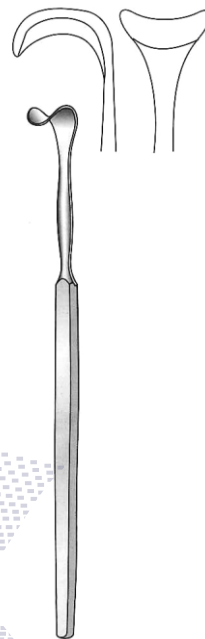

Cottle
J-32-1598
15 cm / 6"
Saddle hook

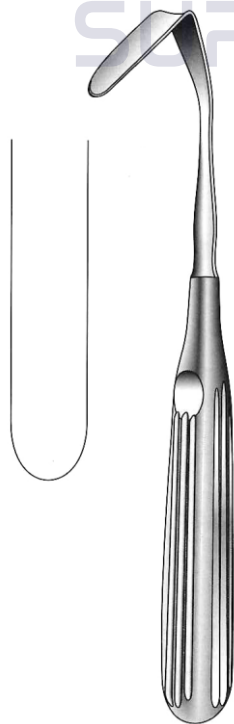

Aufricht
J-33-800
19 cm / 7 1/2"
40 x 12 mm blade

Aufricht
J-33-801
16 cm / 6 1/4"
45 x 6 mm blade

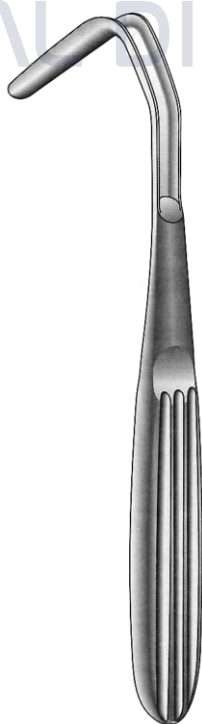

Aufricht
J-32-5510
12.5 cm / 5"
1:2 Teeth
Nasal Retractor

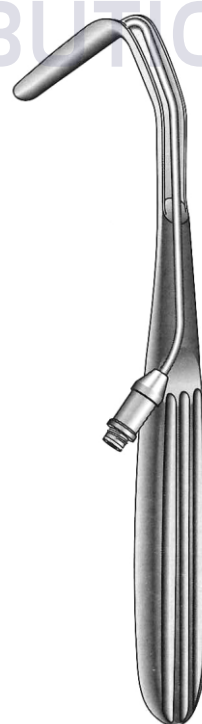

Aufricht
J-32-5512
12.5 cm / 5"
1:2 Teeth
Nasal Retractor
With Fiber Optics

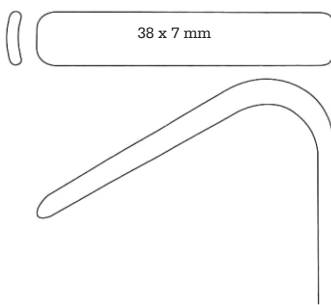

38 x 7 mm

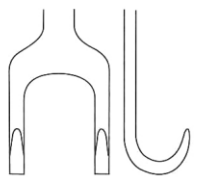

13 x 9 mm

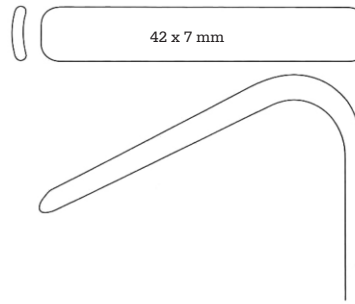

42 x 7 mm

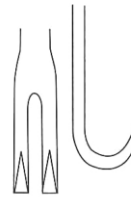

5 x 9 mm

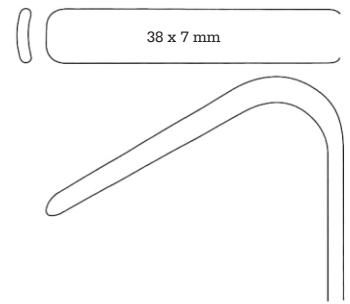

38 x 7 mm

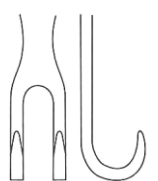

8 x 9 mm



Aufricht
J-32-1621 38 x 7 mm | 13 x 9 mm
J-32-1601 60 x 6.5 mm | 13 x 9 mm
 13.5 cm / 5 1/4"
 Blunt



Aufricht Walter
J-32-5530 42 x 7 mm | 5 x 9 mm
J-32-5535 38 x 7 mm | 8 x 9 mm
 13.5 cm / 5 1/4"

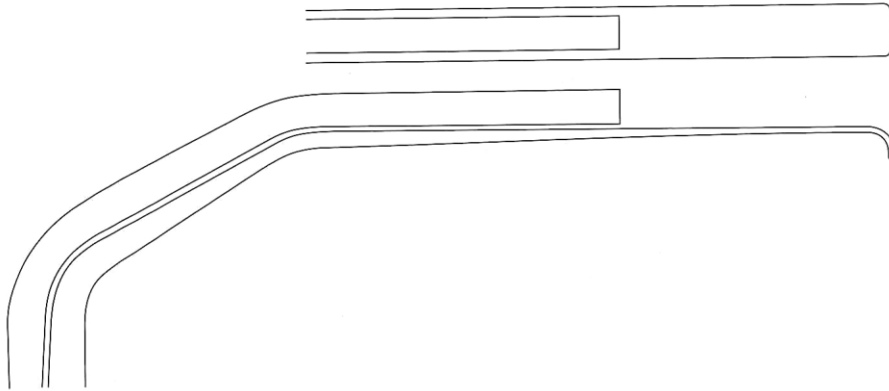

Retractor with fiber optic illumination
including adapter for connection to fiber cable



J-32-5540
18.5 cm / 7 1/4"

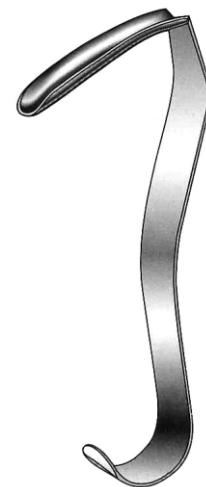
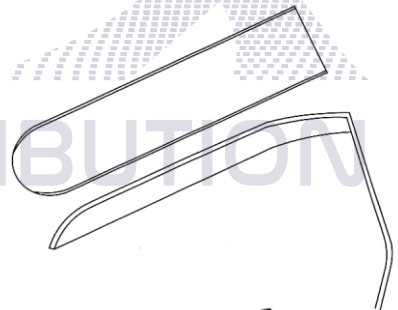

Converse
J-33-650
10.5 cm / 4"
44 x 11 mm blade

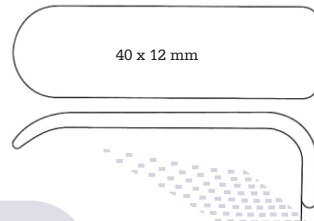
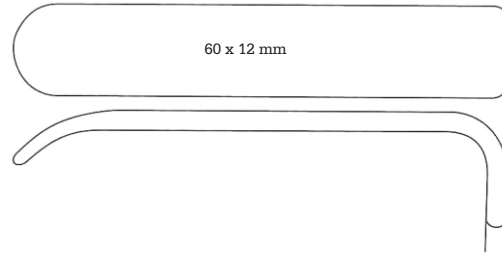
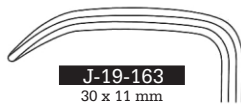
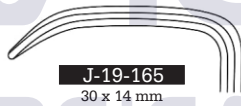
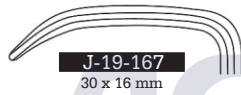
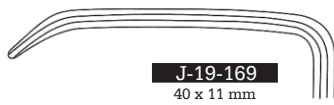

J-19-1280
23 cm / 9"

J-19-1282
23 cm / 9"

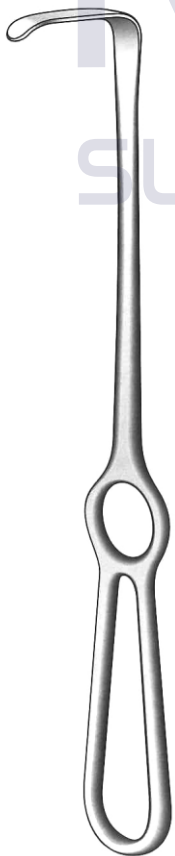

Langenbeck
21 cm / 8¼"



Kocher

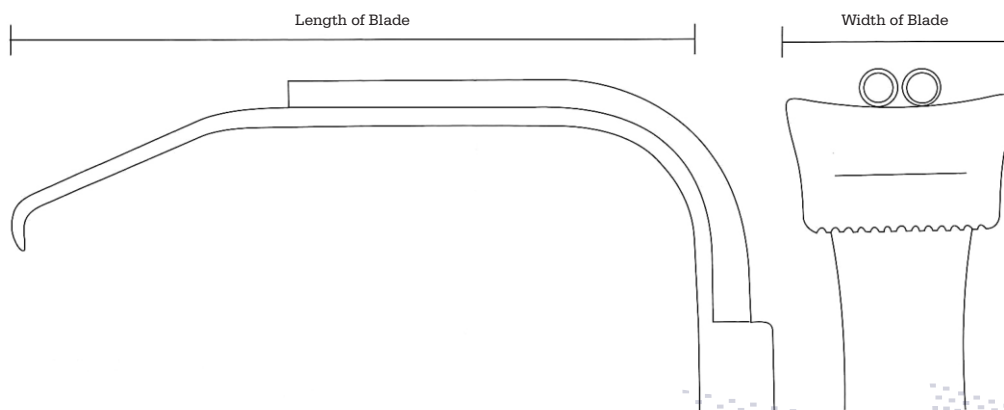

MEDICAL
SURGICAL DISTRIBUTION



Tebbetts
18.5 cm / 7¼"

	Length x Width
J-19-1291	90 x 24 mm
J-19-1292	90 x 30 mm
J-19-1294	115 x 24 mm
J-19-1296	150 x 36 mm
J-19-1298	190 x 30 mm

With fiber optic illumination and irrigation tube
Including adapter for connection to fiber optic cable

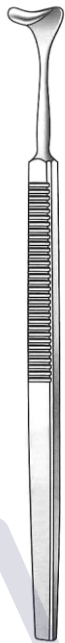

Desmarres
16 cm / 6¼"

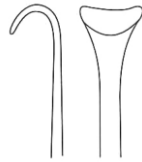

J-19-086
6 x 8 mm

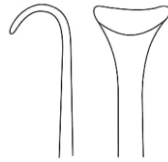

J-19-087
8 x 10 mm

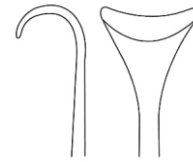

J-19-088
9 x 12 mm

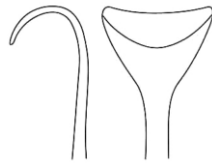

J-19-089
10 x 14 mm

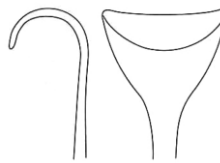

J-19-090
10 x 16 mm

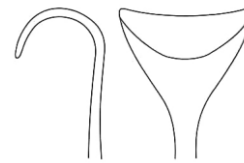

J-19-091
12 x 18 mm



J-33-1020
9/12 x 30 mm



J-33-1022
9/12 x 45 mm



J-33-1024
9/12 x 60 mm

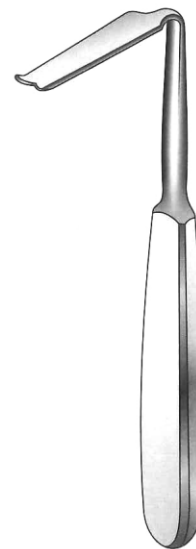

Obwegeser
21 cm / 8¼"
Mandibular rim retractor

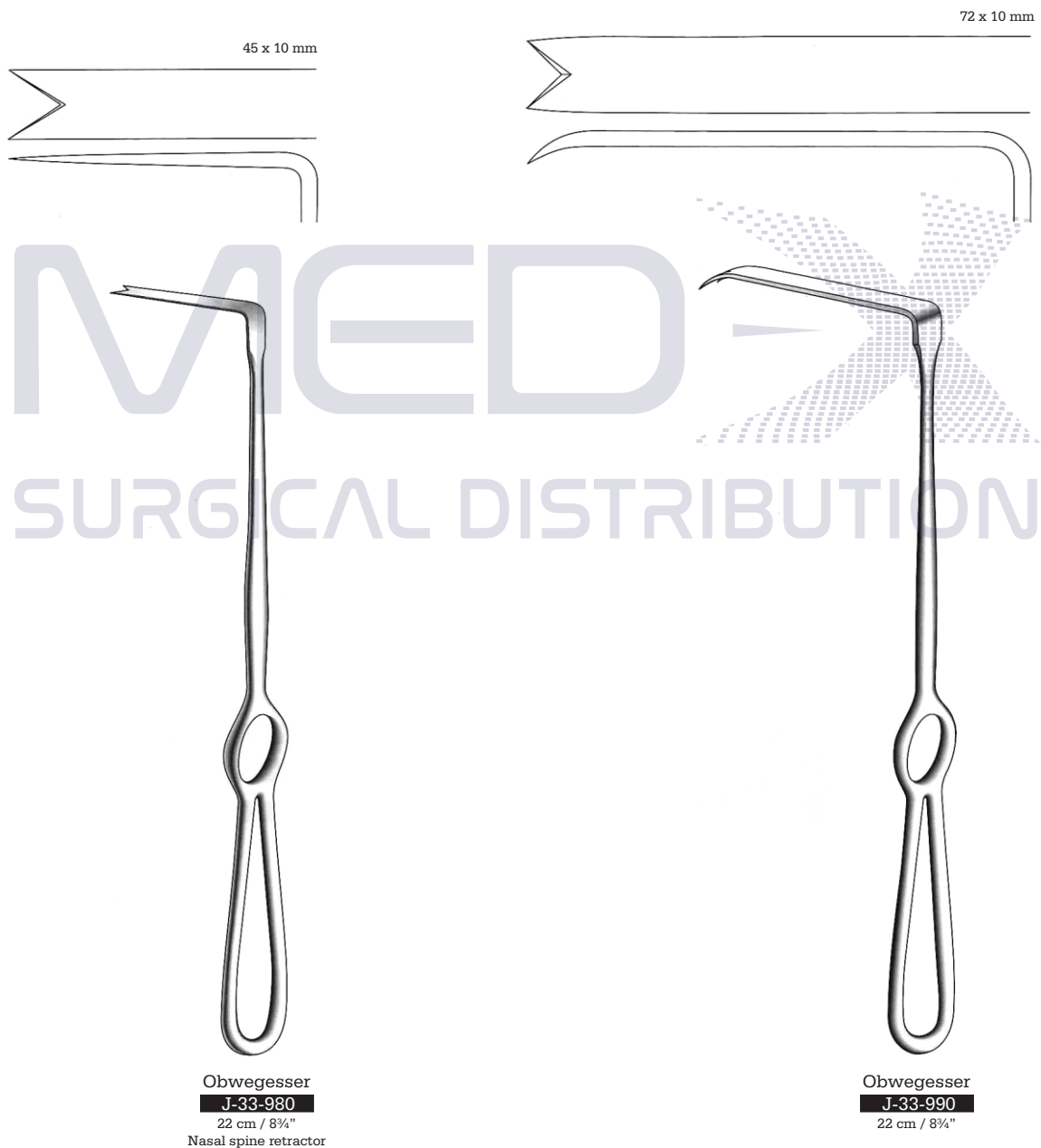

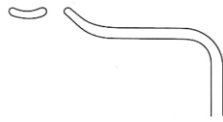

J-33-2310
16 x 5 mm

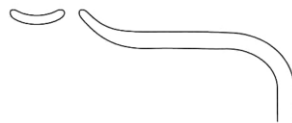

J-33-2311
25 x 7 mm

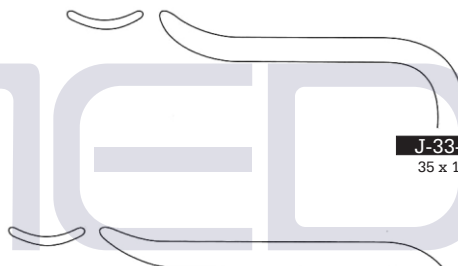

J-33-2312
35 x 10 mm



J-33-2313
42 x 10 mm

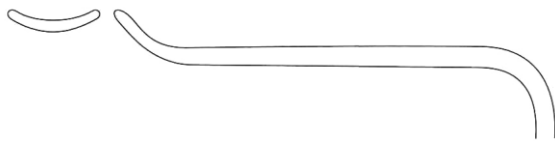

J-33-2314
55 x 12 mm

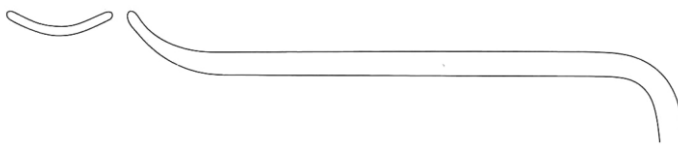

J-33-2315
70 x 14 mm

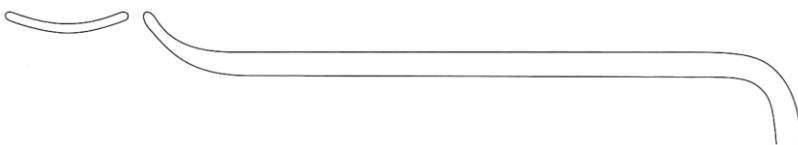

J-33-2316
80 x 16 mm

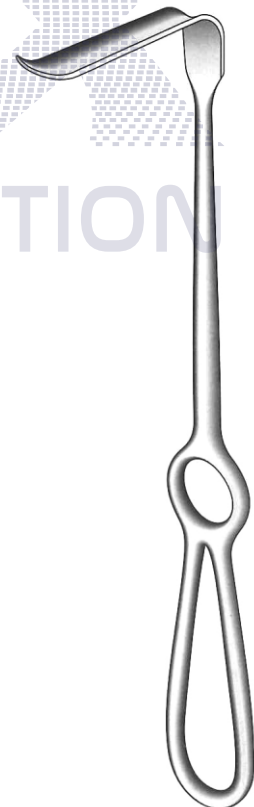

Obwegeser
24 cm / 9½"
Bent upwards

MED
SURGICAL DISTRIBUTION



J-33-2320
16 x 5 mm



J-33-2321
25 x 7 mm



J-33-2322
35 x 10 mm



J-33-2323
42 x 10 mm

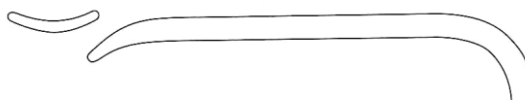

J-33-2324
55 x 12 mm

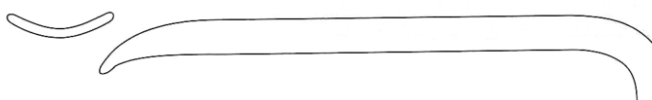

J-33-2325
70 x 14 mm

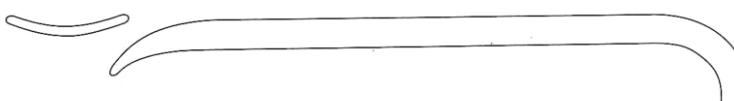

J-33-2326
80 x 16 mm

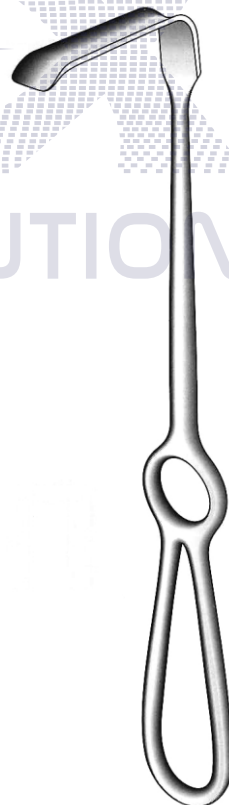
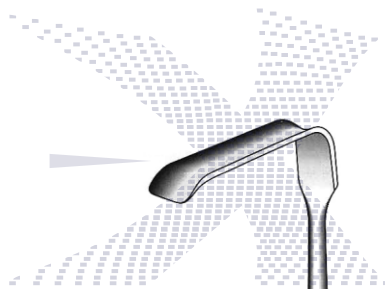

Obwegeser
24 cm / 9½"
Bent downwards

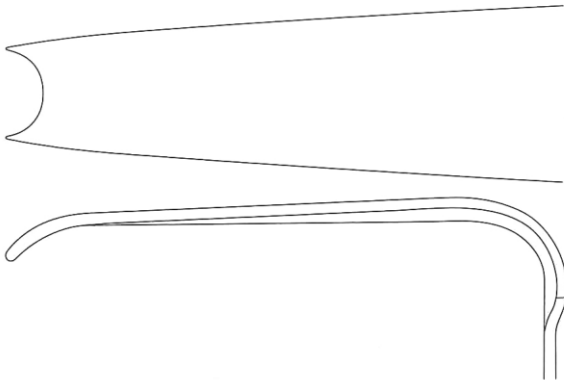

70 x 15/22 mm

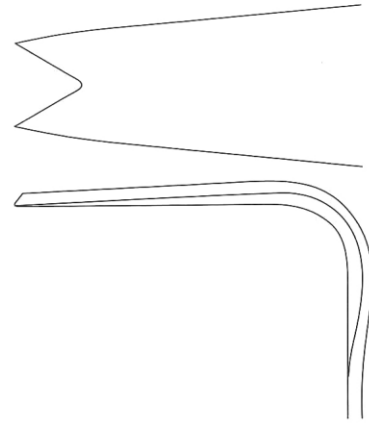

40 x 10/23 mm

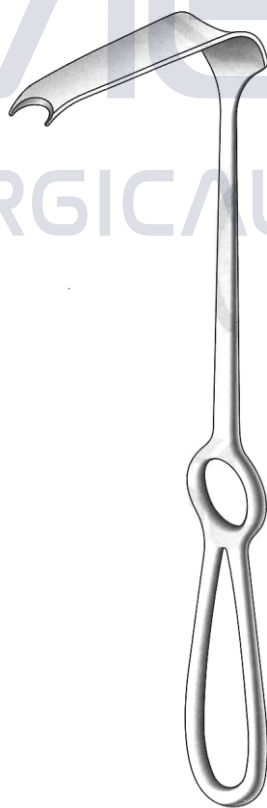

Obwegeser
J-33-930
24 cm / 9½"
Third molar retractor

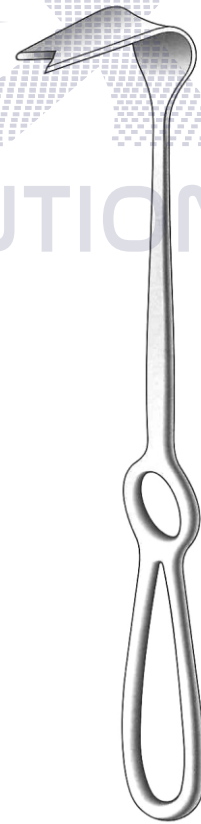

Obwegeser
J-33-1010
24.5 cm / 9¾"
Nasal spine retractor

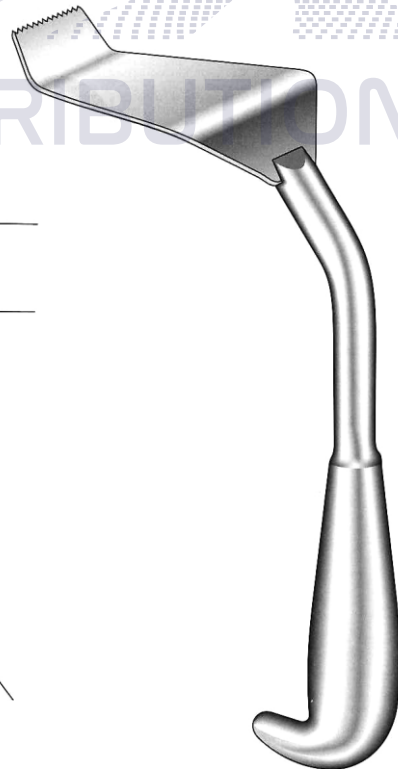
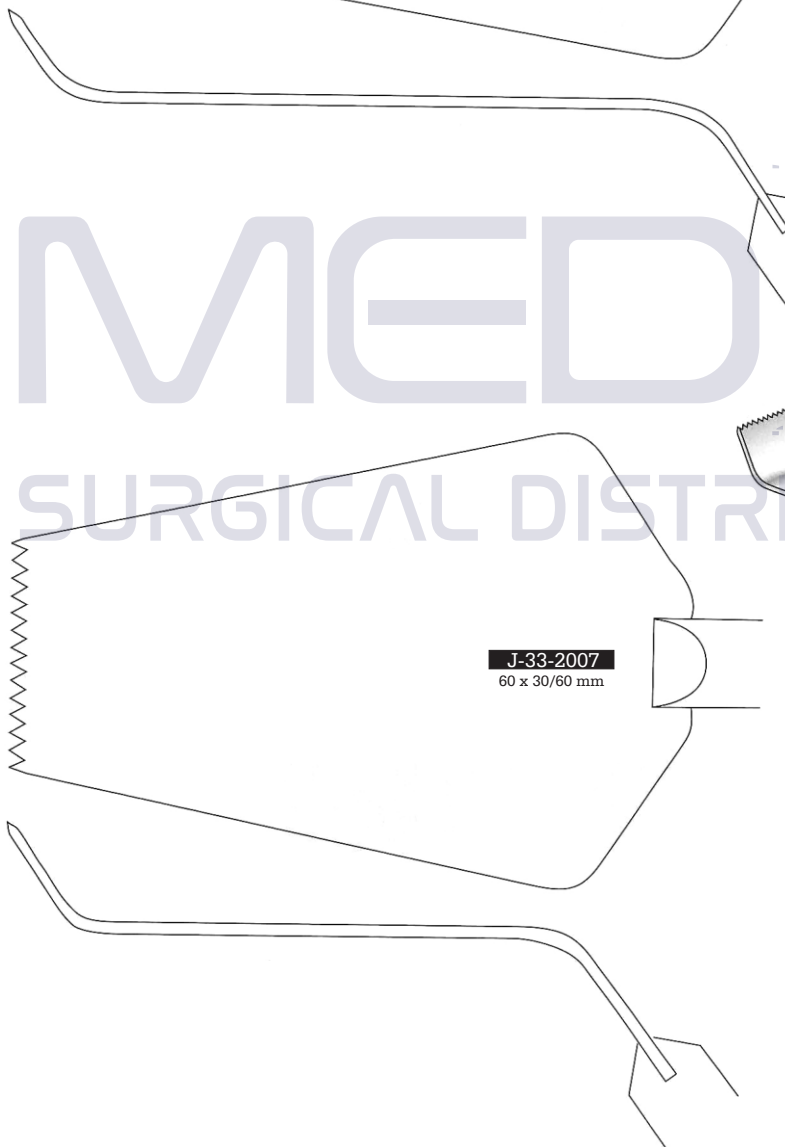
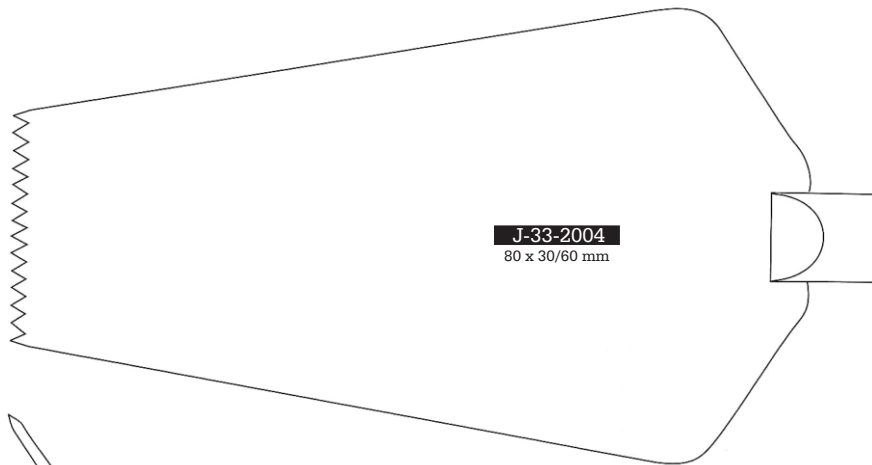

Obwegeser
22 cm / 8 3/4"
Liac crest retractors

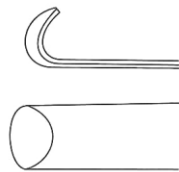

J-33-830
10 x 8 mm



J-33-831
10 x 10 mm

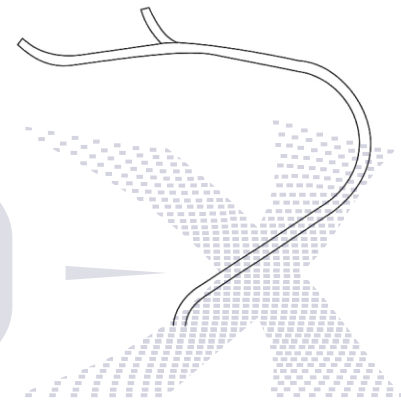
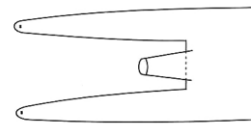

MED X
SURGICAL DISTRIBUTION

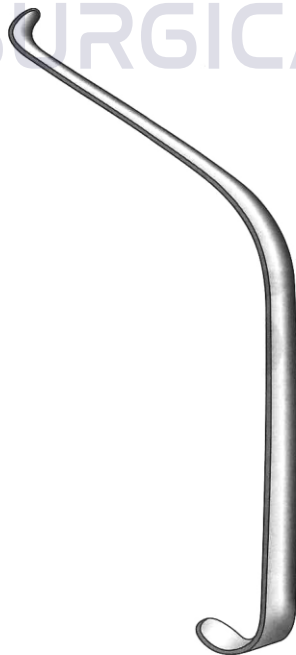

Obwegeser
16.5 cm / 6½"

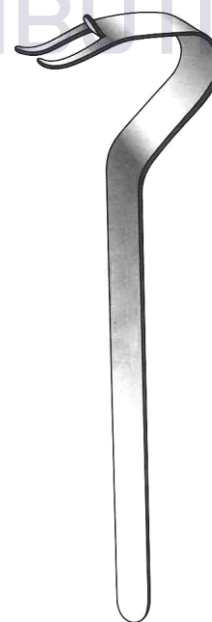

Obwegeser
J-33-700
16 cm / 6¼"
16.5 mm
Chin holder

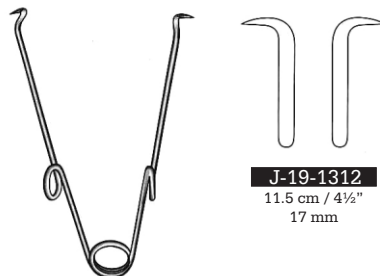
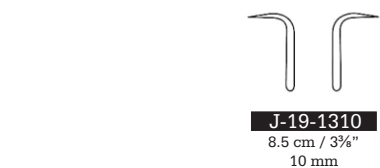

Sharp

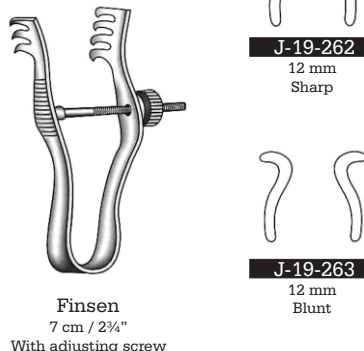
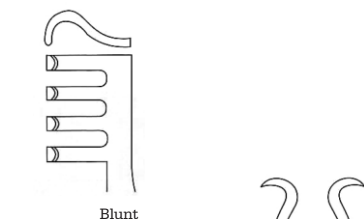
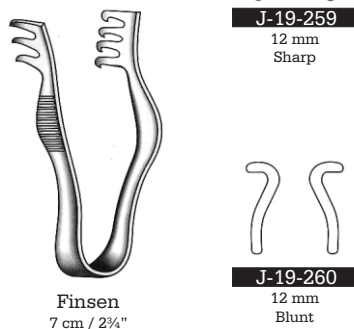
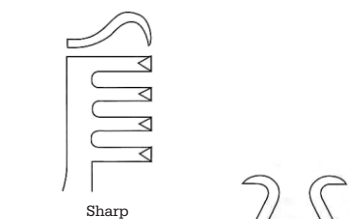
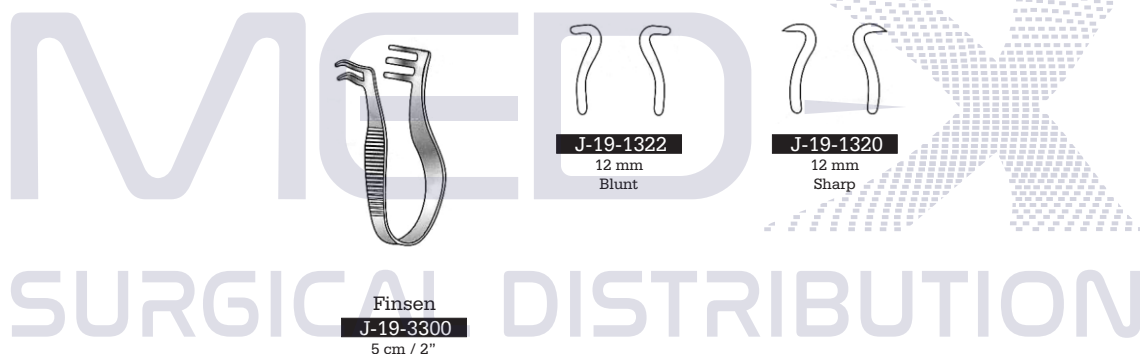
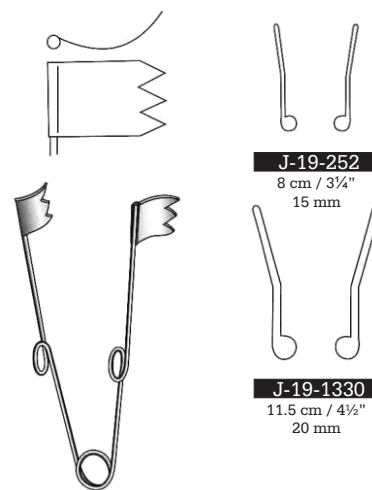

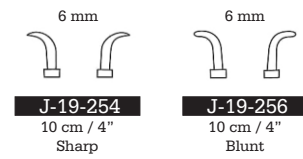
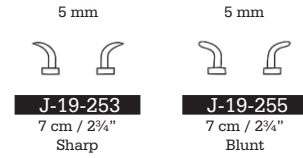
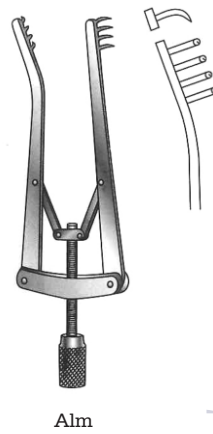
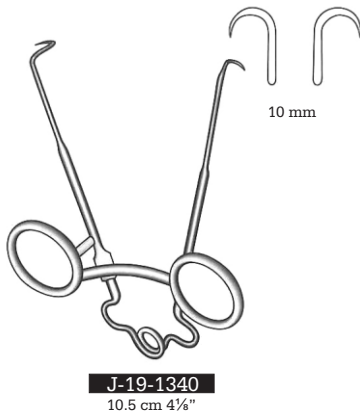

MED 
SURGICAL DISTRIBUTION

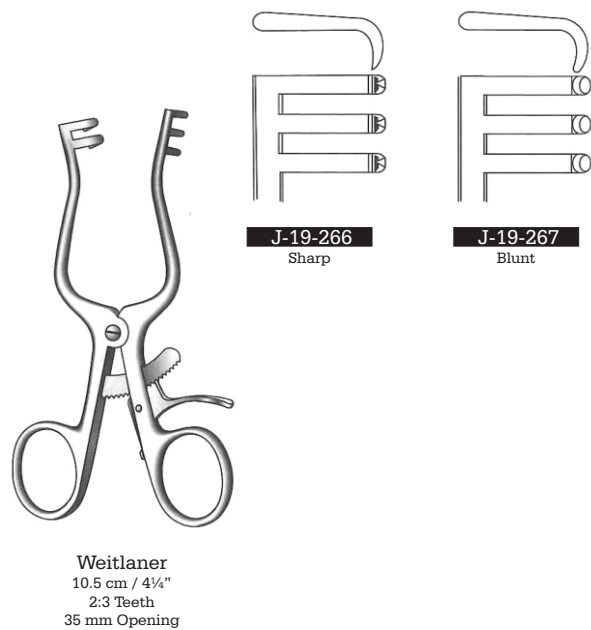
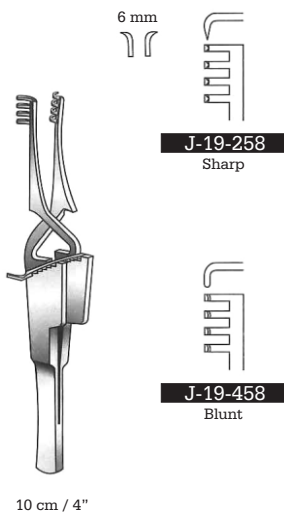

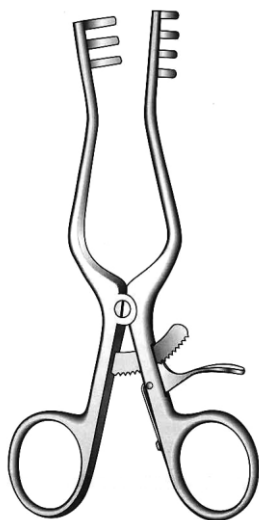

Weitlaner
3:4 Teeth

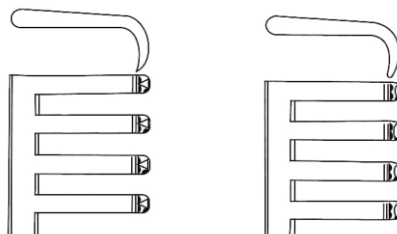

J-19-268	14 cm / 5½"	J-19-468
J-19-270	16.5 cm / 6½"	J-19-470
J-19-271	18 cm / 7"	J-19-471
J-19-272	20 cm / 8"	J-19-472
J-19-273	24.5 cm / 9½"	J-19-473
Sharp		Blunt

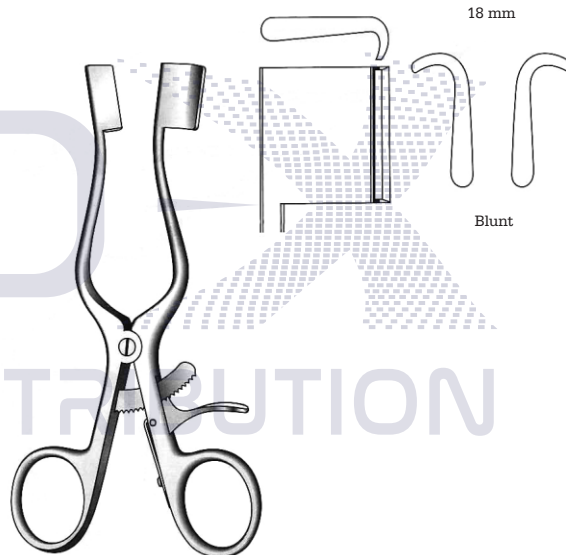

Weitlaner
J-19-277
14 cm / 5½"

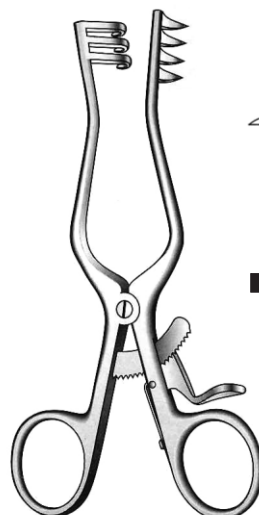

Weitlaner
13 cm / 5½"
3:4 Teeth

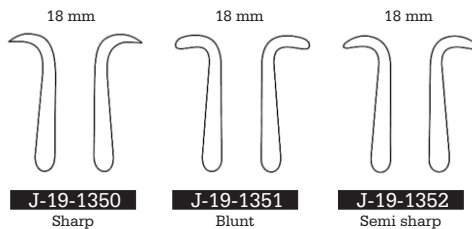

J-19-1350	J-19-1351	J-19-1352
Sharp	Blunt	Semi sharp

ENT & Plastic Surgery Instruments



Otology

Otology

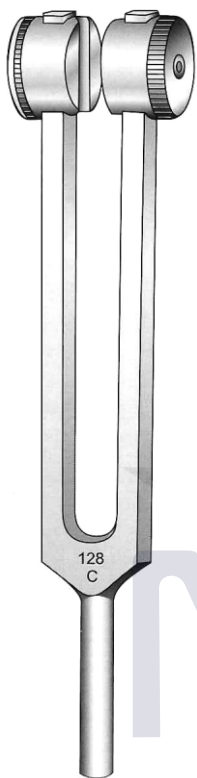

Alloy
J-31-002
C 128

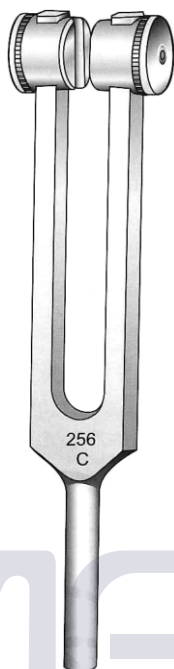

Alloy
J-31-003
C¹ 256



Alloy
J-31-004
C² 512

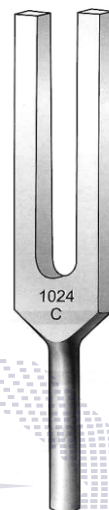

Alloy
J-31-005
C³ 1024

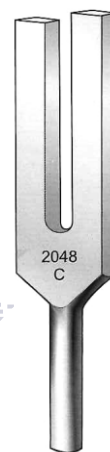

Alloy
J-31-006
C⁴ 2048



Hartmann
J-31-007
C 128



Hartmann
J-31-008
C¹ 256



Hartmann
J-31-009
C² 512



Hartmann
J-31-011
C³ 1024



Hartmann
J-31-012
C⁴ 2048



Hartmann
J-31-013
C⁵ 4096



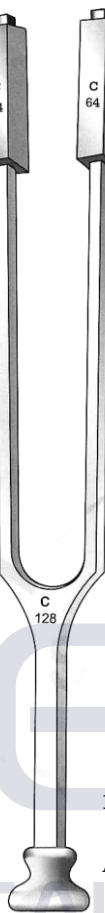
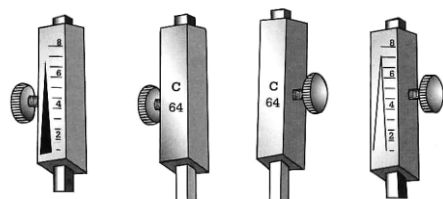

Rydel-Seiffert
J-31-026
C 64 / C 128
Also for neurology

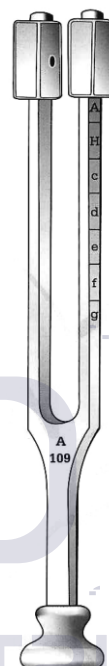

Konig
J-31-027
A 109
Movable up to g

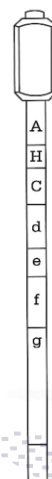

J-31-028
a¹ 440



Lucae
J-31-031
C 128

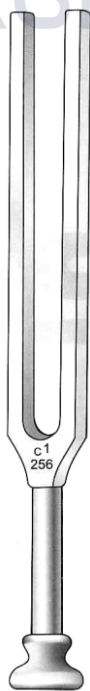

Lucae
J-31-032
c¹ 256



Lucae
J-31-033
C² 512



Lucae
J-31-034
C³ 1024



Lucae
J-31-035
c⁴ 2048



Lucae
J-31-036
c⁵ 4096



Troeltsch
J-31-015
 Set of 3



J-31-016
 6 mm \varnothing
 Fig.1



J-31-017
 7 mm \varnothing
 Fig.2



J-31-018
 8 mm \varnothing
 Fig.3



Hartmann
J-31-042
 Set of 5



J-31-041
 3 mm \varnothing
 Fig.1



J-31-040
 4 mm \varnothing
 Fig.2



J-31-043
 5 mm \varnothing
 Fig.3



J-31-044
 6 mm \varnothing
 Fig.4



J-31-045
 7 mm \varnothing
 Fig.5



Hartmann
J-31-065
 Set of 4



J-31-060
 4.5 mm \varnothing
 Fig.1



J-31-070
 5.5 mm \varnothing
 Fig.2



J-31-080
 6.5 mm \varnothing
 Fig.3



J-31-081
 7.5 mm \varnothing
 Fig.4



Toynbee
J-31-095
 Set of 4



J-31-090
 4.5 mm \varnothing
 Fig.1



J-31-100
 5.5 mm \varnothing
 Fig.2



J-31-110
 6.5 mm \varnothing
 Fig.3



J-31-111
 7.5 mm \varnothing
 Fig.4



Poltzer
J-31-125
 Set of 4



J-31-120
 3 mm \varnothing
 Fig.1



J-31-130
 4.5 mm \varnothing
 Fig.2



J-31-140
 5.5 mm \varnothing
 Fig.3



J-31-141
 6.5 mm \varnothing
 Fig.4



Pritchard
J-31-155
 Set of 3



J-31-150
 4.5 mm \varnothing
 Fig.1



J-31-160
 6.5 mm \varnothing
 Fig.2



J-31-170
 7.5 mm \varnothing
 Fig.3



Erhardt
J-31-175 Round
J-31-205 Oval
 Set of 3



J-31-180
 4.5 mm \varnothing
 Fig.1



J-31-207
 4.5 mm \varnothing
 Fig.1



J-31-190
 5.5 mm \varnothing
 Fig.2



J-31-208
 5.5 mm \varnothing
 Fig.2



J-31-200
 6.5 mm \varnothing
 Fig.3



J-31-209
 6.5 mm \varnothing
 Fig.3



Gruber
J-31-212 Round
J-31-214 Oval
 Set of 4



J-31-210
 4.5 mm \varnothing
 Fig.1



J-31-222
 4.5 mm \varnothing
 Fig.1



J-31-220
 5.5 mm \varnothing
 Fig.2



J-31-224
 5.5 mm \varnothing
 Fig.2



J-31-216
 6.5 mm \varnothing
 Fig.3



J-31-226
 6.5 mm \varnothing
 Fig.3



J-31-218
 7.5 mm \varnothing
 Fig.4



J-31-228
 7.5 mm \varnothing
 Fig.4

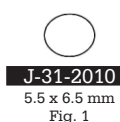

J-31-2010
5.5 x 6.5 mm
Fig. 1

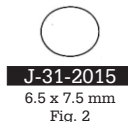

J-31-2015
6.5 x 7.5 mm
Fig. 2

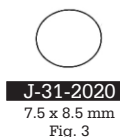

J-31-2020
7.5 x 8.5 mm
Fig. 3

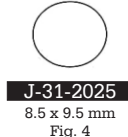

J-31-2025
8.5 x 9.5 mm
Fig. 4

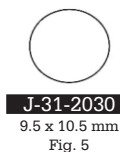

J-31-2030
9.5 x 10.5 mm
Fig. 5

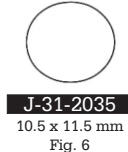

J-31-2035
10.5 x 11.5 mm
Fig. 6



Zollner
J-31-2000
3.8 cm / 1½"
Set of 6 pieces
Oval, Black



Farrior
J-31-149
3.6 cm / 1½"
Set of 7 pieces
Black



J-31-142
5.5 mm \varnothing
Fig. 1



J-31-143
6.5 mm \varnothing
Fig. 2



J-31-144
7.5 mm \varnothing
Fig. 3



J-31-145
8.5 mm \varnothing
Fig. 4



J-31-146
9.5 mm \varnothing
Fig. 5



J-31-147
10.5 mm \varnothing
Fig. 6

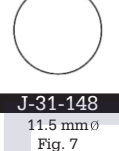

J-31-148
11.5 mm \varnothing
Fig. 7

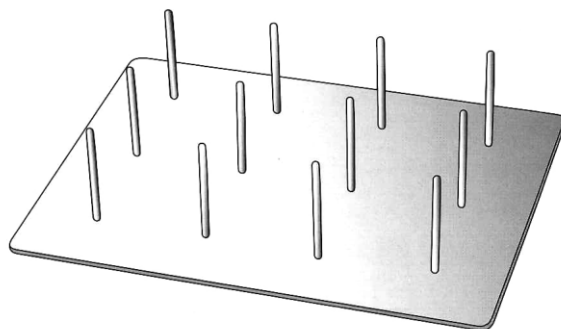

J-31-245
Ear specula storage rack

SURGICAL DISTRIBUTION

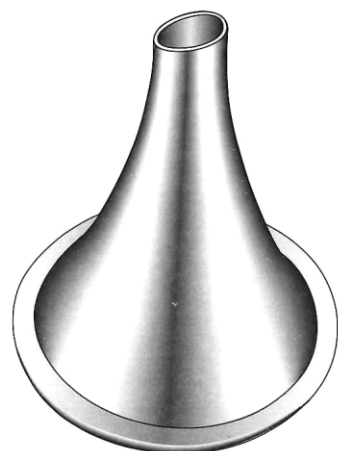

J-31-2100
Oval, Angled end
Set of 9 pieces

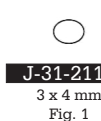

J-31-2110
3 x 4 mm
Fig. 1



J-31-2115
4 x 5 mm
Fig. 2



J-31-2120
4.5 x 5.5 mm
Fig. 3

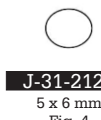

J-31-2125
5 x 6 mm
Fig. 4



J-31-2130
5.5 x 6.5 mm
Fig. 5

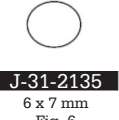

J-31-2135
6 x 7 mm
Fig. 6



J-31-2140
6.5 x 7.5 mm
Fig. 7



J-31-2145
7 x 8 mm
Fig. 8

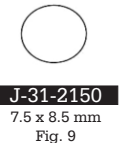

J-31-2150
7.5 x 8.5 mm
Fig. 9



Boucheron
J-31-2160
Round
Set of 4



J-31-2165
Fig. 1



J-31-2170
Fig. 2



J-31-2175
Fig. 3



J-31-2180
Fig. 4



J-31-250
 6.5 mm ϕ



J-31-260
 7 mm ϕ



J-31-270
 8 mm ϕ

Siegle
J-31-241
 Complete set

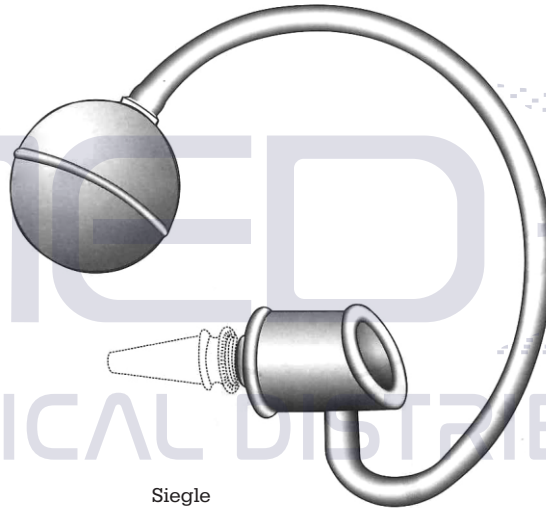

Siegle
J-31-240

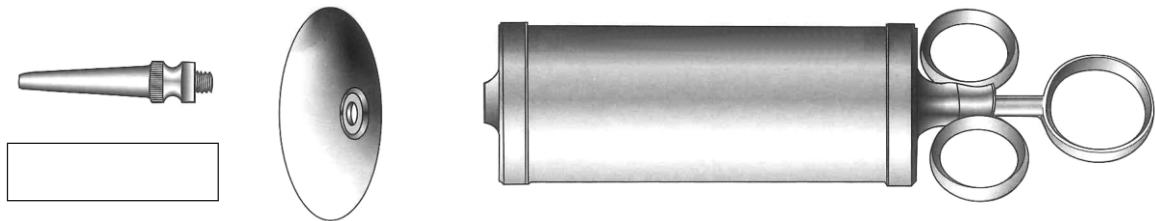

Pimeroy
J-31-280 50 c.c.
J-31-290 75 c.c.
J-31-300 100 c.c.
J-31-310 150 c.c.
J-31-320 200 c.c.

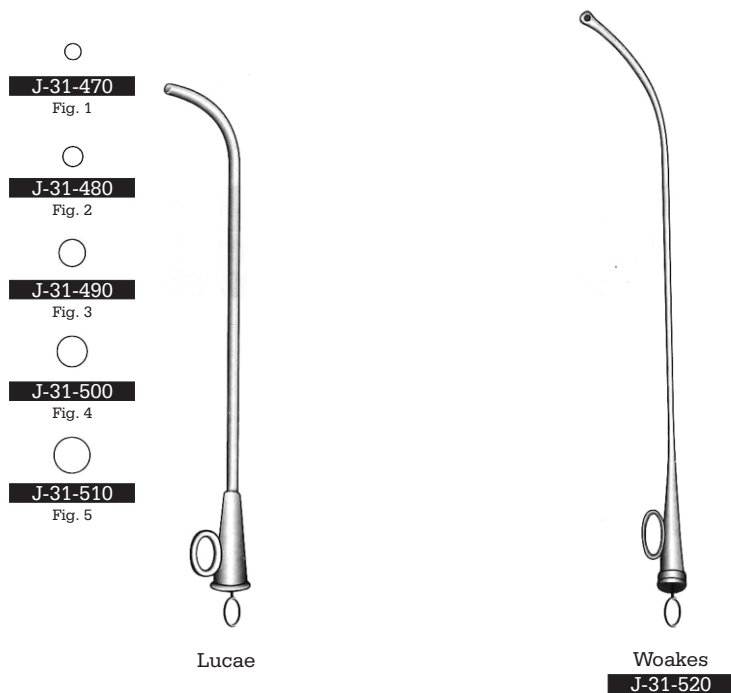
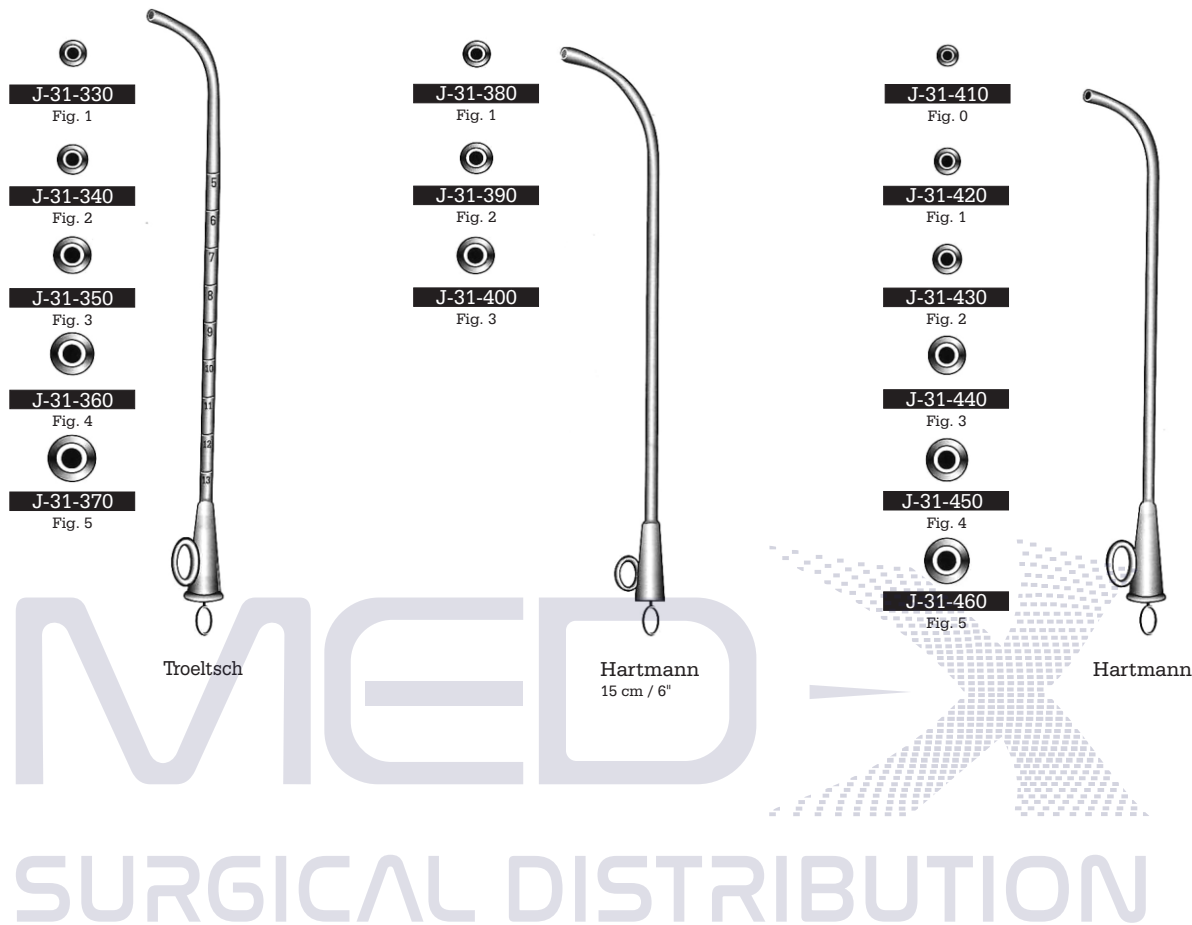

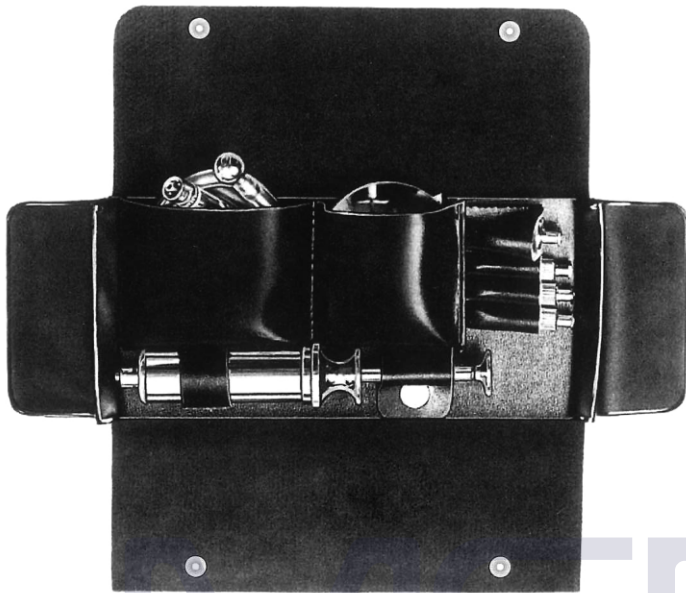

J-31-2200
 Ear syringe, complete
 self filling in plastic pouch

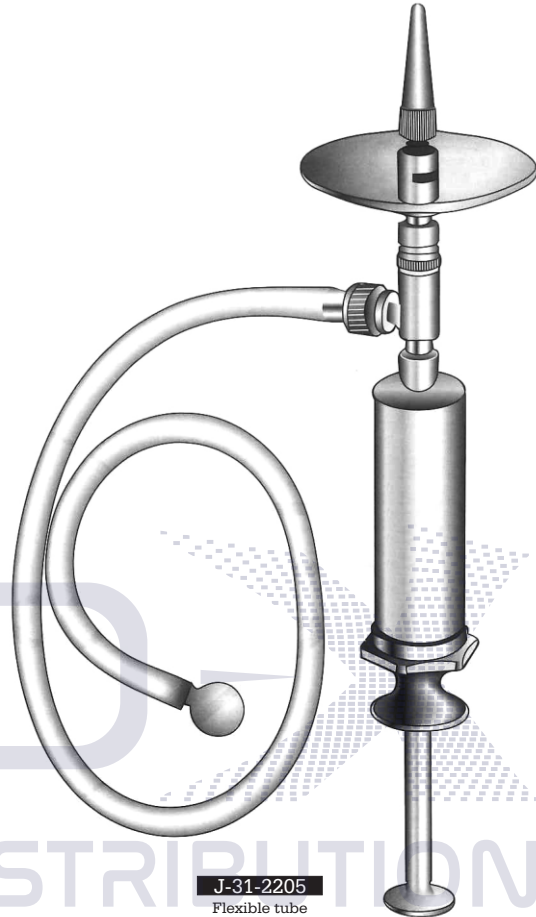

J-31-2205
 Flexible tube

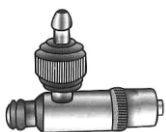

J-31-2210
 Valve attachment



J-31-2215
 Suction nozzle

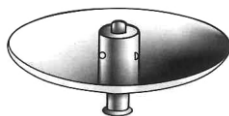

J-31-2220
 Protecting disc



J-31-2225
 Metal olive



J-31-2230
 Conical tip



J-31-2235
 Button ended tip



J-31-2240
 Threaded tip

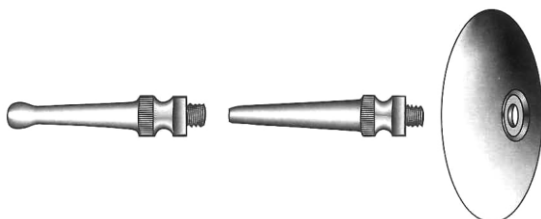

J-31-2250 50 ml
J-31-2260 75 ml
J-31-2270 100 ml
 Ear syringe, complete with
 protecting disc and 2 tips

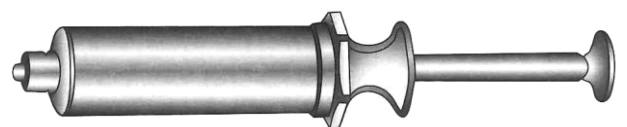



J-31-2305
Connecting nozzle



J-31-2310
4 mm \emptyset
Ear olive



J-31-2315
15 mm \emptyset
Nose olive



J-31-2320
17 mm \emptyset
Nose olive



J-31-2325
22 mm \emptyset
Nose olive

MEDIX
SURGICAL DISTRIBUTION



Poltzer
J-31-2300
J-31-2301 Complete set



Barbara
16 cm / 6 1/4"

J-31-2370	0.3 mm
J-31-2372	0.6 mm
J-31-2374	1.0 mm

25°

J-31-2390	0.3 mm
J-31-2392	0.6 mm
J-31-2394	1.0 mm
J-31-2396	1.2 mm
J-31-2398	1.5 mm
J-31-2400	2.0 mm
J-31-2402	2.5 mm

45°

J-31-2410	0.3 mm
J-31-2412	0.6 mm
J-31-2414	1.0 mm
J-31-2416	1.2 mm
J-31-2418	1.5 mm
J-31-2420	2.0 mm
J-31-2422	2.5 mm

90°

J-31-2430	0.5 mm
J-31-2432	1.0 mm

Rosen
16 cm / 6 1/4"

SURGICAL DISTRIBUTION



15.5 cm / 6"

J-31-2440	0.3 mm
J-31-2442	0.6 mm
J-31-2444	1.0 mm

90°

J-31-2450	0.3 mm
J-31-2452	0.6 mm
J-31-2454	1.0 mm

90°

J-31-2460	0.5 mm
J-31-2465	1.0 mm

McGee
For footplate

J-31-2470	0.5 mm
J-31-2475	1.0 mm

McGee
For footplate



Barbara
15.5 cm / 6"

J-31-2480
J-31-2485

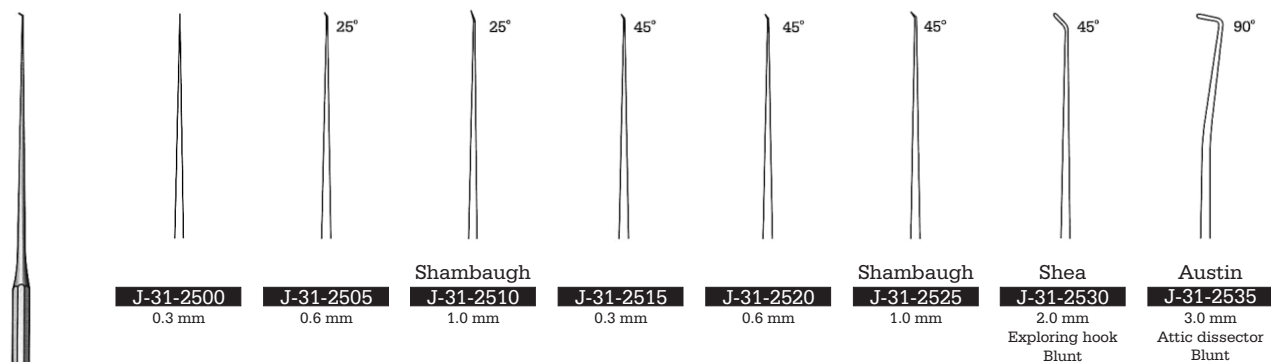

MEDIX
SURGICAL DISTRIBUTION

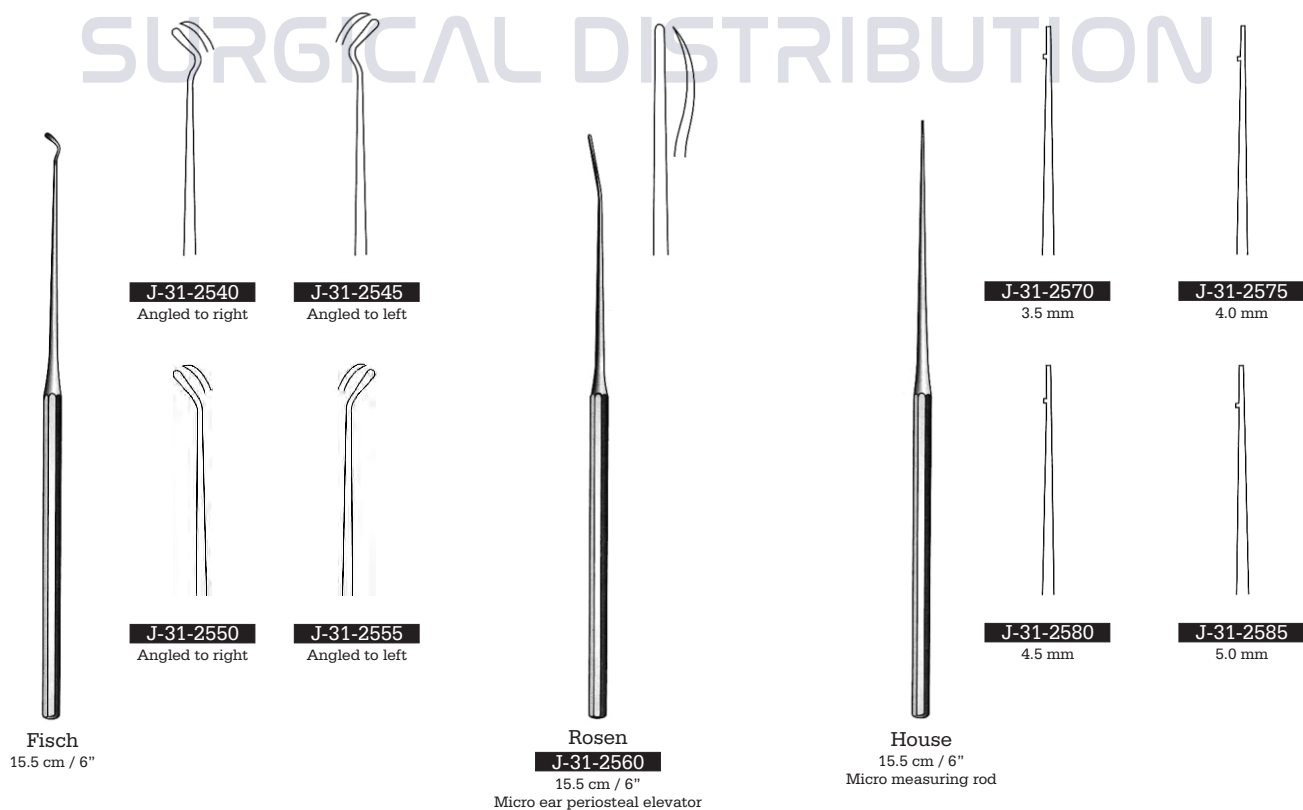

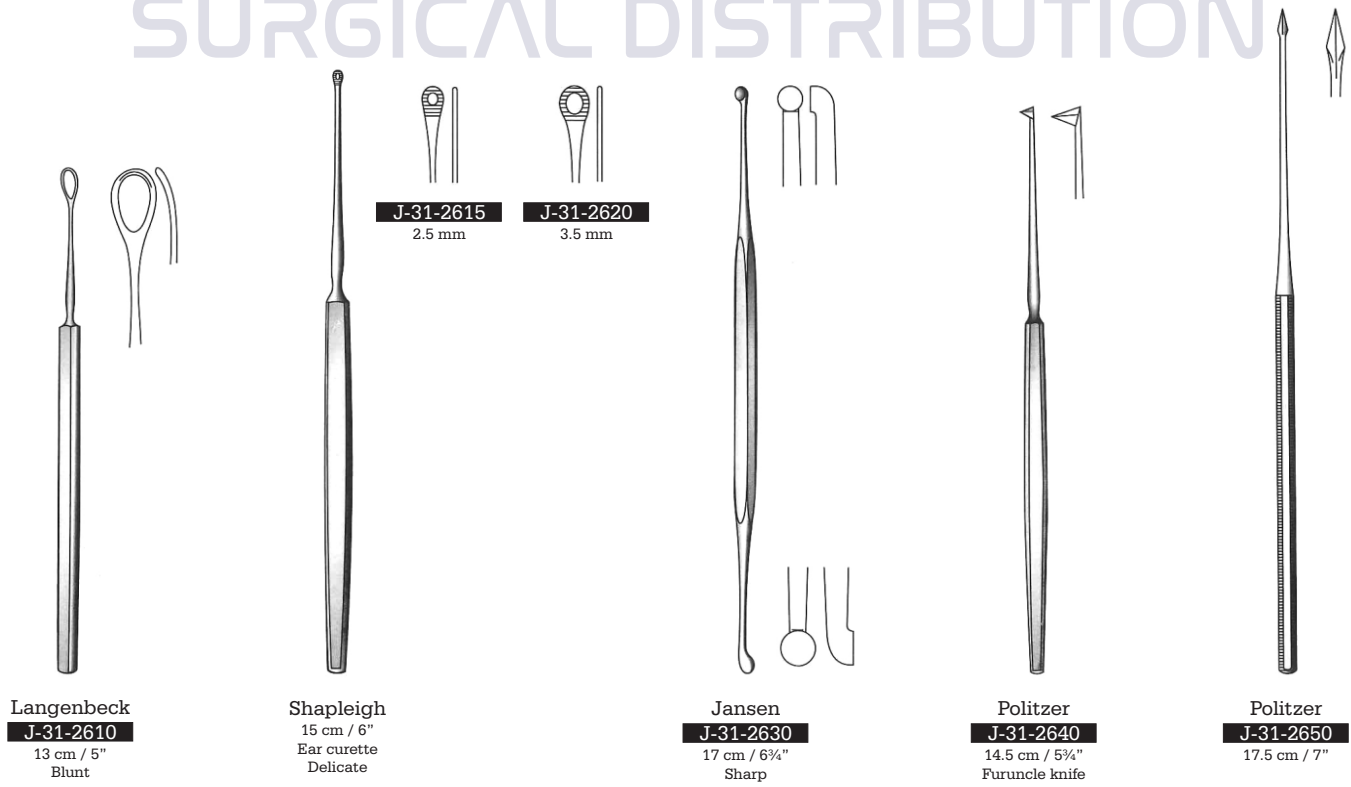
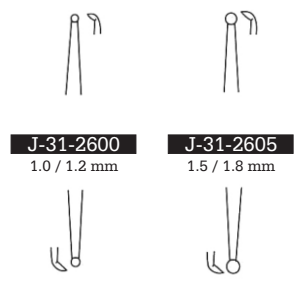
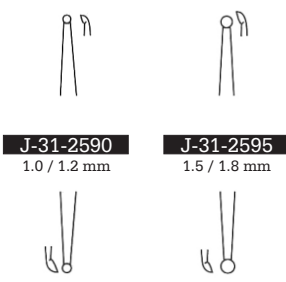
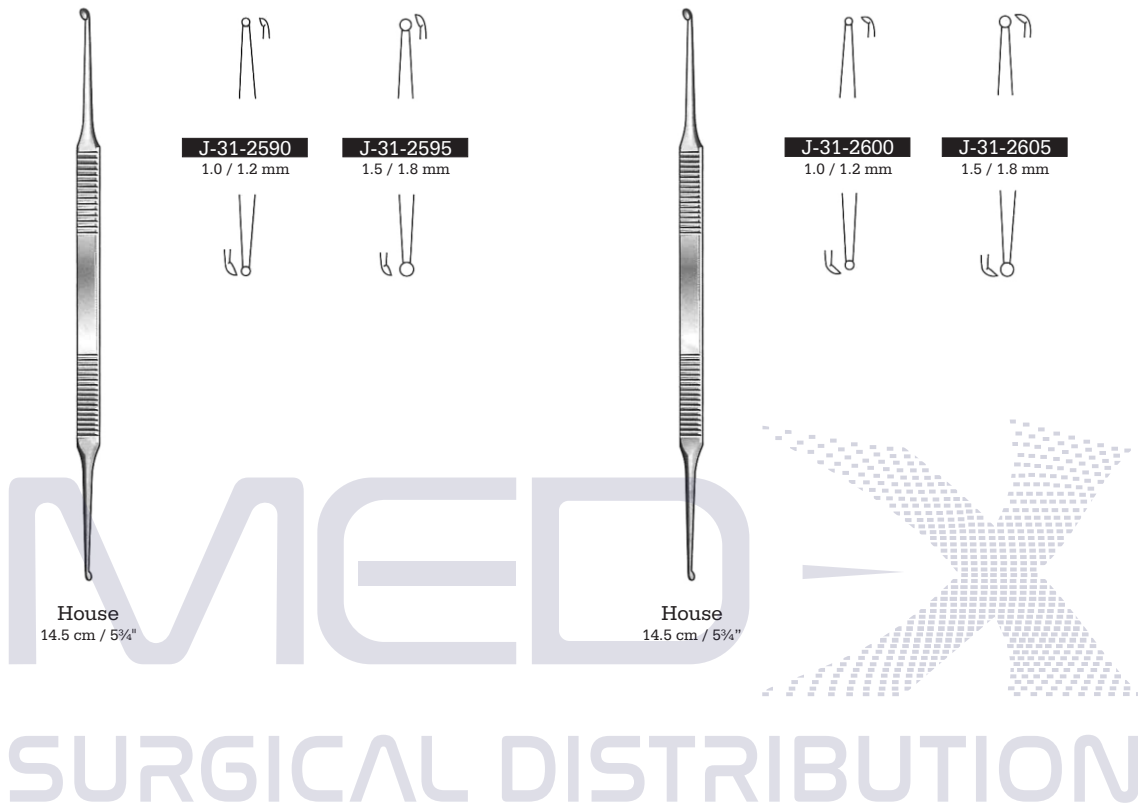

Langenbeck
J-31-2610
 13 cm / 5"
 Blunt

Shapleigh
 15 cm / 6"
 Ear curette
 Delicate

Jansen
J-31-2630
 17 cm / 6 3/4"
 Sharp

Politzer
J-31-2640
 14.5 cm / 5 3/4"
 Furuncle knife

Politzer
J-31-2650
 17.5 cm / 7"

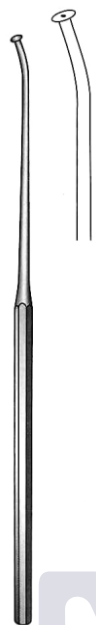

Schuknecht
J-31-2660
Rotary knife



Schuknecht
J-31-2670
14.5 cm / 5 3/4"
Sickle knife



Wullstein
J-31-2680
15.5 cm / 6"
Sickle knife



Tabb
J-31-2690
Mucosa knife



Plester
J-31-2700
15 cm / 6"
Flap knife

SURGICAL DISTRIBUTION



Rosen
15 cm / 6"
Circular cut knives



J-31-2710
1 mm ϕ
Fig. 7



J-31-2715
1.4 mm ϕ
Fig. 6



J-31-2720
1.6 mm ϕ
Fig. 5



J-31-2725
2 mm ϕ
Fig. 4



J-31-2730
2.6 mm ϕ
Fig. 3



J-31-2735
2.8 mm ϕ
Fig. 2



J-31-2740
3 mm ϕ
Fig. 1

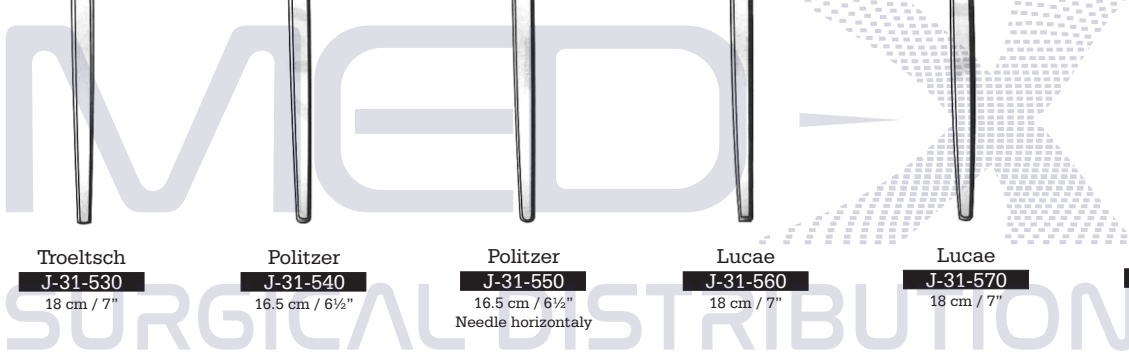
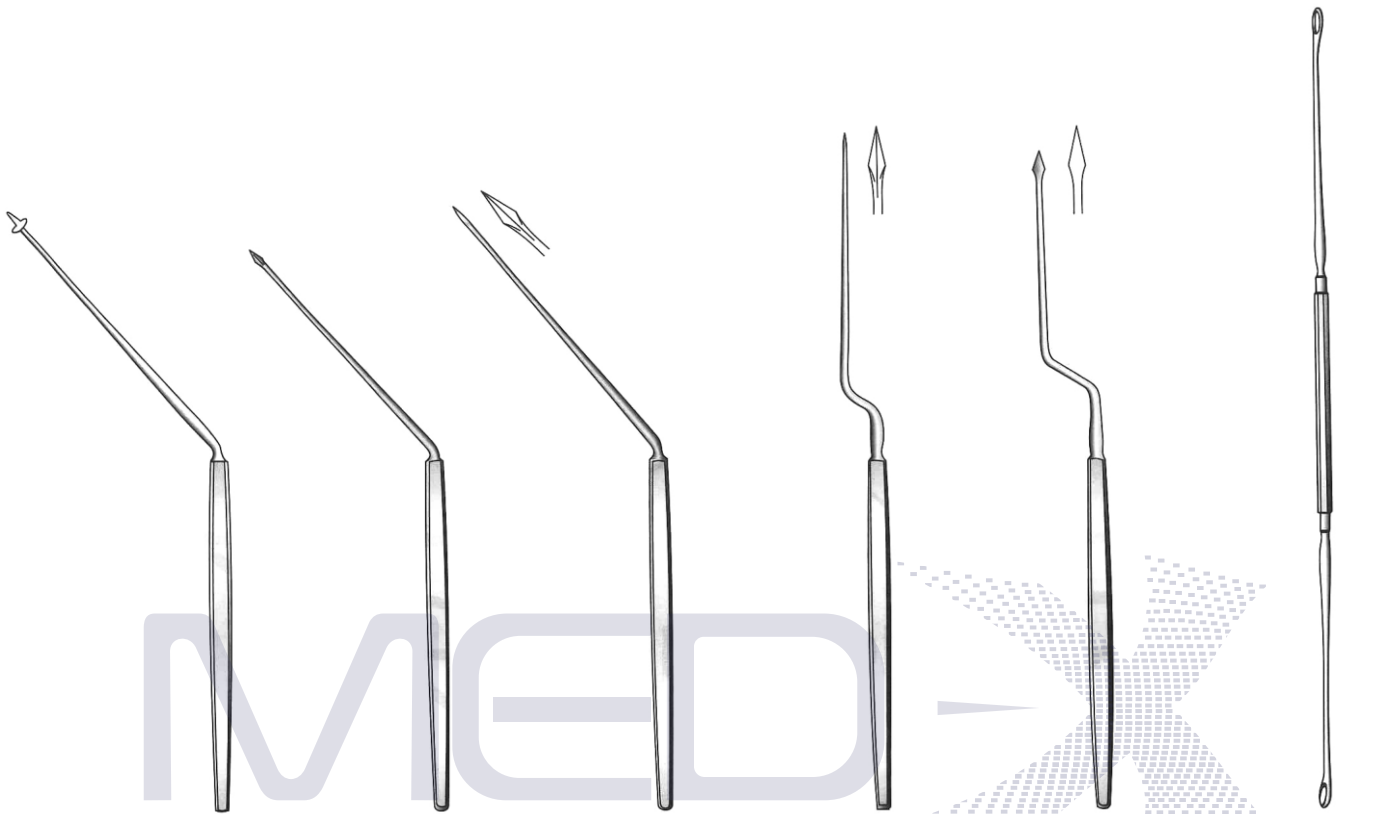

Troeltsch
J-31-530
 18 cm / 7"

Politzer
J-31-540
 16.5 cm / 6½"

Politzer
J-31-550
 16.5 cm / 6½"
 Needle horizontal

Lucae
J-31-560
 18 cm / 7"

Lucae
J-31-570
 18 cm / 7"

Barker
J-31-580
 17 cm / 6¾"



Gross
J-31-590
 12 cm / 4¾"
 Blunt / Sharp



Gross
J-31-600
 12 cm / 4¾"
 Blunt
 Ear scoop / hook



Gross
J-31-610
 12 cm / 4¾"
 Blunt



Gross
J-31-620
 12 cm / 4¾"
 Blunt / Sharp



Gross
J-31-630
 12 cm / 4¾"



J-31-640
 2.75 mm

J-31-650
 3.75 mm

J-31-660
 5.5 mm

Billeau
 16.5 cm / 6½"
 Ear loop



Weber-Loch
J-31-2760
16.5 cm / 6½"
Ear loop

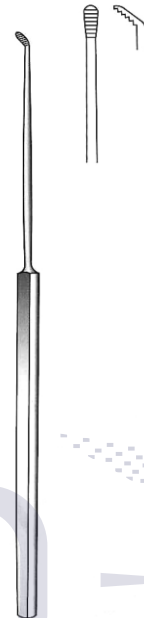

Moldenhauer
J-31-2770
15.5 cm / 6"
Foreign body lever

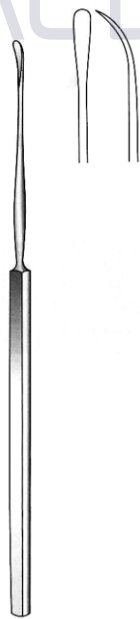

Zaufal
J-31-2780
15 cm / 6"
Foreign body lever



Hartmann
J-31-2790
16 cm / 6¼"
Sharp, ear hooklet

MEDIX
SURGICAL DISTRIBUTION

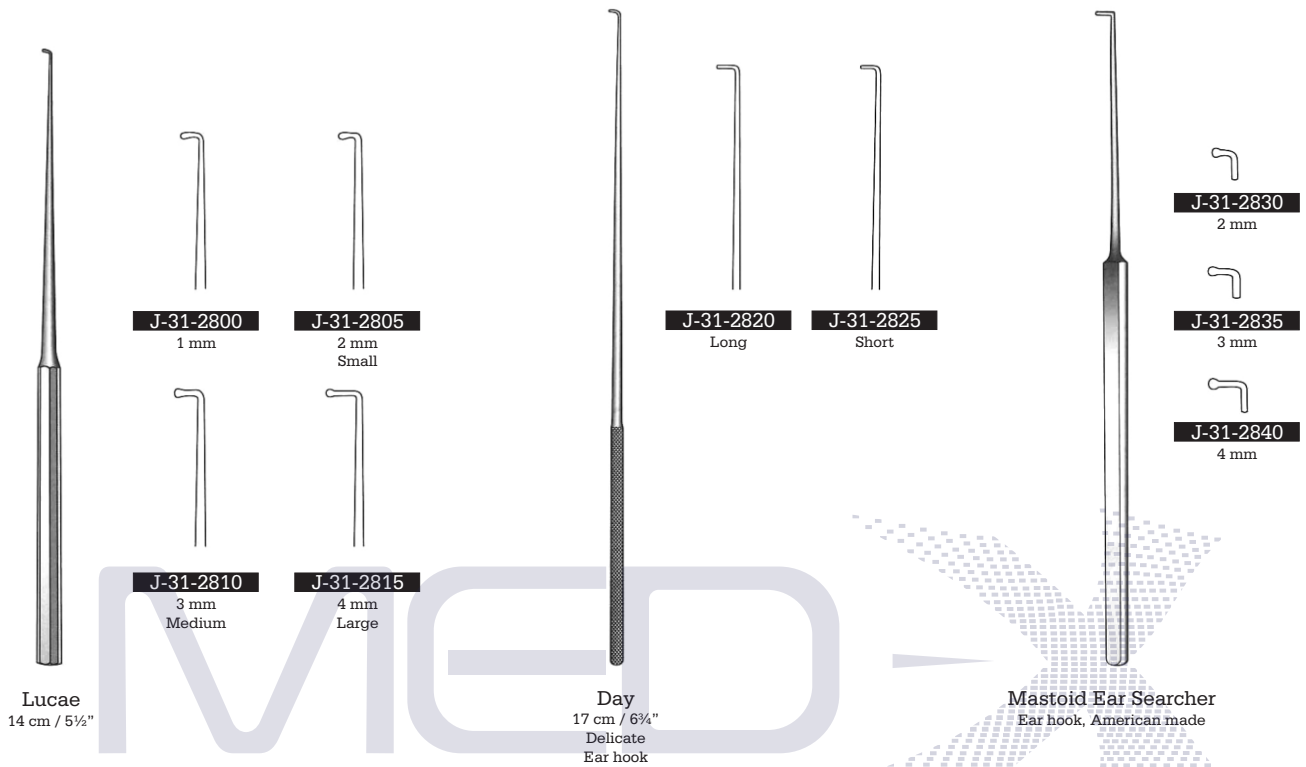

SURGICAL DISTRIBUTION

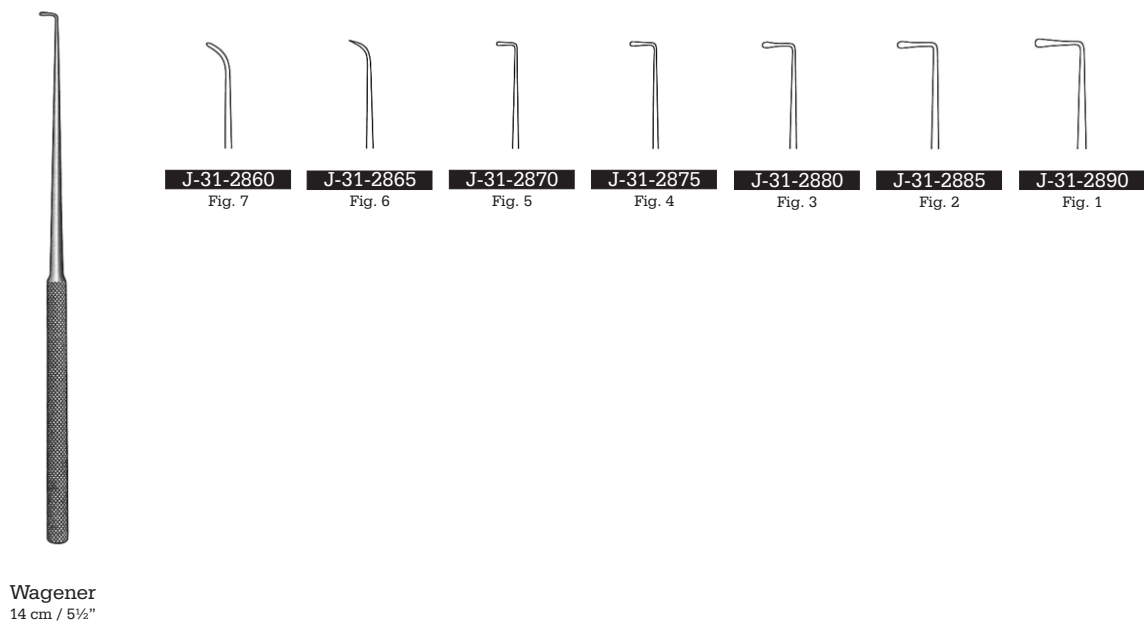

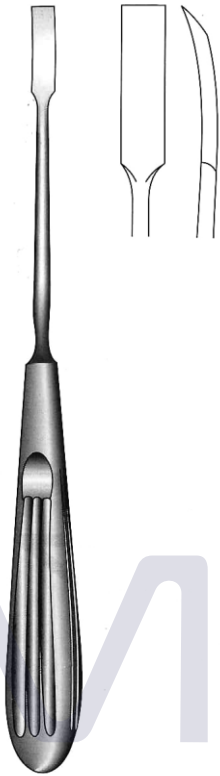

Lempert
J 31-2900
20.5 cm / 8"
6 mm



Lempert
J-31-2910
18 cm / 7"
6 mm

MEDIX
SURGICAL DISTRIBUTION



Lempert
21.5 cm / 8½"
Sharp

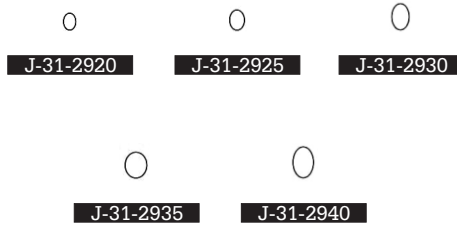

J-31-2920

J-31-2925

J-31-2930









J-31-2935

J-31-2940



Buck
 16.5 cm / 6½"



				
	Fig. 000	Fig. 00	Fig. 0	Fig. 1
Blunt	J-31-670	J-31-680	J-31-690	J-31-700
Sharp	J-31-750	J-31-760	J-31-770	J-31-780
				
	Fig. 2	Fig. 3	Fig. 4	Fig. 5
Blunt	J-31-710	J-31-720	J-31-730	J-31-740
Sharp	J-31-790	J-31-800	J-31-810	J-31-820



- J-31-830** Fig. 000
- J-31-840** Fig. 00
- J-31-850** Fig. 0
- J-31-860** Fig. 1
- J-31-870** Fig. 2
- J-31-880** Fig. 3
- J-31-890** Fig. 4
- J-31-900** Fig. 5

Round handle
 Blunt



- J-31-910** Fig. 000
- J-31-920** Fig. 00
- J-31-930** Fig. 0
- J-31-940** Fig. 1
- J-31-950** Fig. 2
- J-31-960** Fig. 3
- J-31-970** Fig. 4
- J-31-980** Fig. 5

Round handle
 Sharp

Buck
 16.5 cm / 6½"
 extra extra fine



- J-31-831** Fig. 000
- J-31-841** Fig. 00
- J-31-851** Fig. 0
- J-31-861** Fig. 1
- J-31-871** Fig. 2
- J-31-881** Fig. 3
- J-31-891** Fig. 4
- J-31-901** Fig. 5

Octagonal handle
 Blunt







- J-31-911** Fig. 000
- J-31-921** Fig. 00
- J-31-931** Fig. 0
- J-31-941** Fig. 1
- J-31-951** Fig. 2
- J-31-961** Fig. 3
- J-31-971** Fig. 4
- J-31-981** Fig. 5

Octagonal handle
 Sharp

Buck
 16.5 cm / 6½"



Myles
 17 cm / 6¾"

-  **J-32-1620**
-  **J-32-1630**
-  **J-32-1640**
-  **J-32-1650**
-  **J-32-1660**

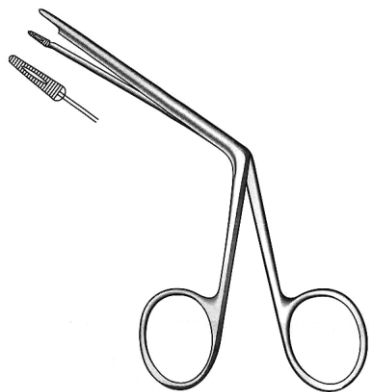

Littauer
J-31-1120
12 cm / 4¾"

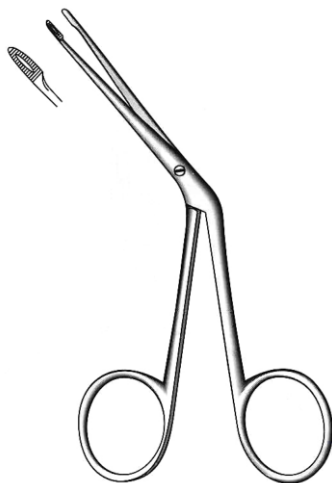

Hartmann
J-31-1130
12 cm / 4¾"
Fine model

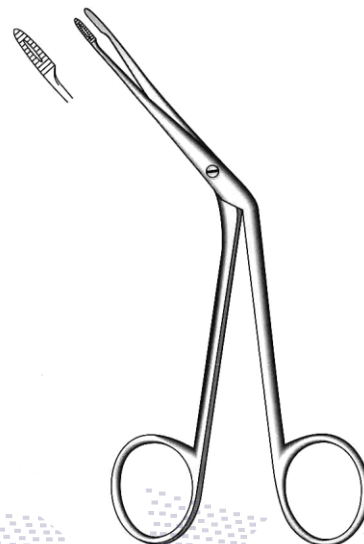

Hartmann
J-31-1140
14 cm / 5 ½"
Regular model

MEDIX
SURGICAL DISTRIBUTION

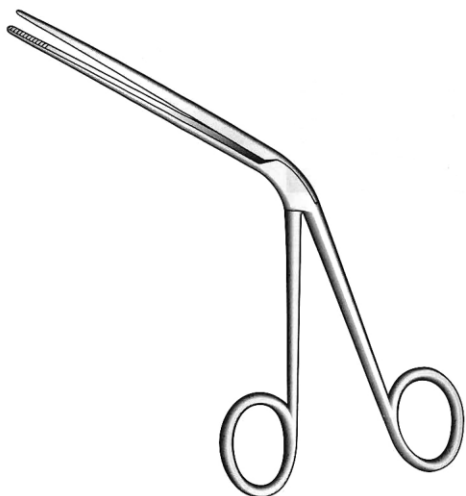

Tilley
J-31-1150
16.5 cm / 6½"

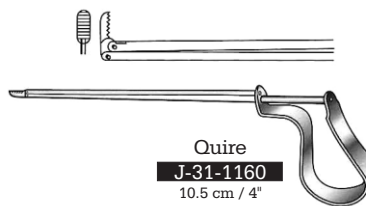

Quire
J-31-1160
10.5 cm / 4"
Foreign body lever

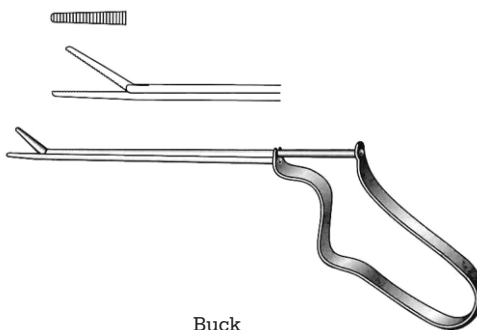

Buck
J-31-1170
11.5 cm / 4½"
Foreign body forceps

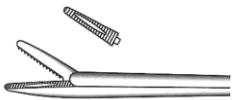

Hartmann
J-31-1180 8.5 cm / 3½"
J-31-1182 12 cm / 4¾"
J-31-1190 14 cm / 5½"
J-31-1200 16.5 cm / 6½"



Hartmann Wullstein
J-31-1210
 8.5 cm / 3½"

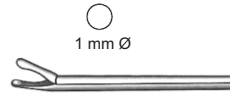

Hartmann Wullstein
J-31-1220
 8.5 cm / 3½"

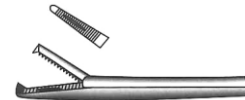

Hartmann
J-31-1230 8.5 cm / 3½"
J-31-1232 12 cm / 4¾"
J-31-1240 14 cm / 5½"
 1:2 Teeth

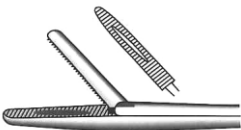

Hartmann Noyes
J-31-1250
 9 cm / 3½"



Hartmann Noyes
J-31-1260
 9 cm / 3½"
 1:2 Teeth

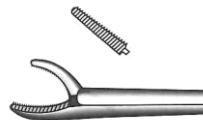

Hartmann Weingartner
J-31-1270
 8.5 cm / 3½"

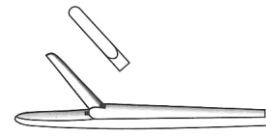

Hartmann
J-31-1280
 8.5 cm / 3½"



Hartmann
J-31-1290 8.5 cm / 3½"
J-31-1291 12 cm / 4¾"
J-31-1292 14 cm / 5½"
 2 mm Ø



Hartmann
J-31-1320
 8.5 cm / 3½"



Struempel
J-31-1330
 8.5 cm / 3½"

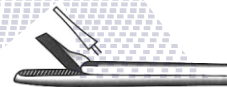

Hartmann
J-31-1340
 8.5 cm / 3½"

J-31-1300 8.5 cm / 3½"
J-31-1301 12 cm / 4¾"
J-31-1302 14 cm / 5½"
 2.5 mm Ø

J-31-1310 8.5 cm / 3½"
J-31-1311 12 cm / 4¾"
J-31-1312 14 cm / 5½"
 3 mm Ø



Hartmann
J-31-1350
 8.5 cm / 3½"



Hartmann Hoffmann
J-31-1360
 8.5 cm / 3½"

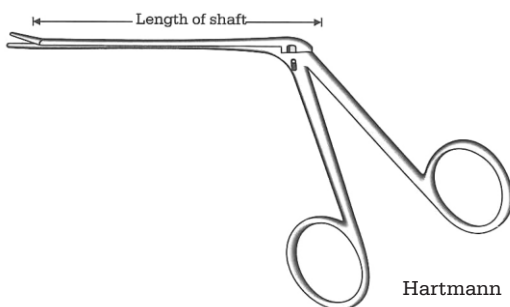



J-31-3000

80 mm

J-31-3001

110 mm

Smooth, Straight

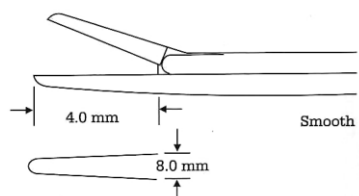

J-31-3050

80 mm

J-31-3051

110 mm

Serrated, Straight

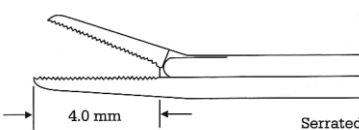

J-31-3055

80 mm

J-31-3056

110 mm

Upward, Serrated



J-31-3060

80 mm

J-31-3061

110 mm

Right, Serrated

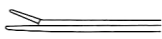

J-31-3065

80 mm

J-31-3066

110 mm

Left, Serrated



J-31-3080

80 mm

J-31-3081

110 mm

Smooth, straight

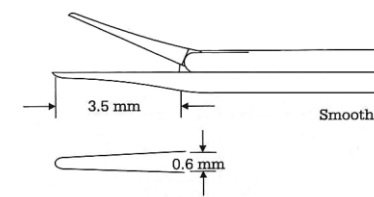

J-31-3090

80 mm

J-31-3091

110 mm

Serrated, straight

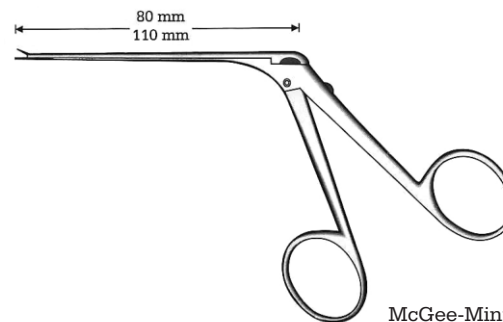
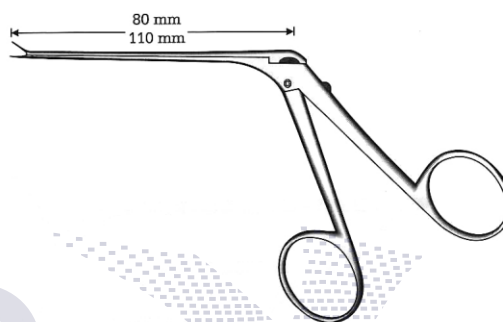
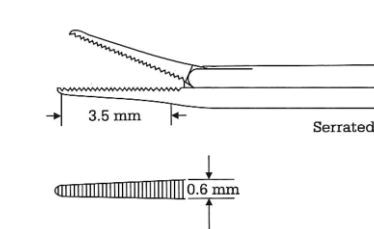

MEDICAL DISTRIBUTION

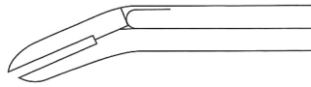

J-31-3100
J-31-3105 Black finish
 80 mm

J-31-3101
J-31-3106 Black finish
 110 mm
 0.8 x 3.5 mm



J-31-3110
J-31-3115 Black finish
 80 mm

J-31-3111
J-31-3116 Black finish
 110 mm
 0.8 x 6 mm

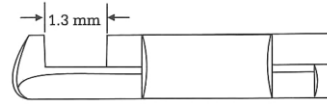

J-31-3120
J-31-3125 Black finish
 80 mm

J-31-3121
J-31-3126 Black finish
 110 mm
 Upward cutting

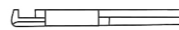

J-31-3130
J-31-3135 Black finish
 80 mm

J-31-3131
J-31-3136 Black finish
 110 mm
 Downward cutting

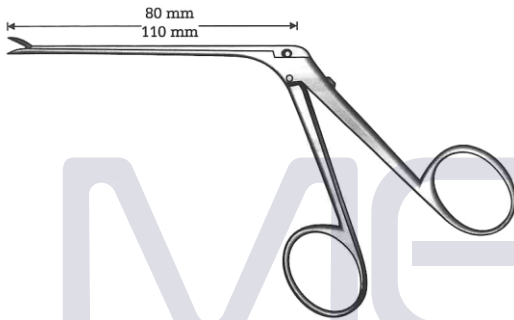
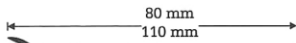

McGee
 Wire bending forceps
 bends downward

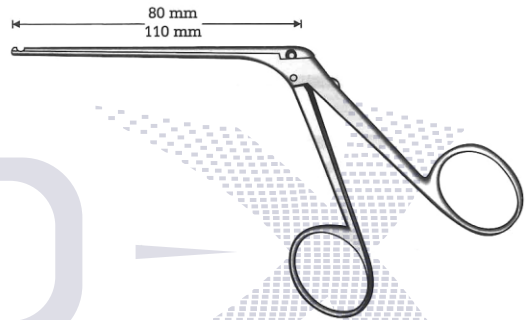
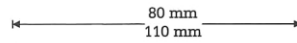

House-Dieter
 Malleus nipper

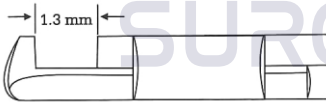

J-31-3150
J-31-3155 black finish
 80 mm

J-31-3151
J-31-3156 black finish
 110 mm
 Right cutting

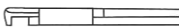

J-31-3160
J-31-3165 black finish
 80 mm

J-31-3161
J-31-3166 black finish
 110 mm
 Left cutting

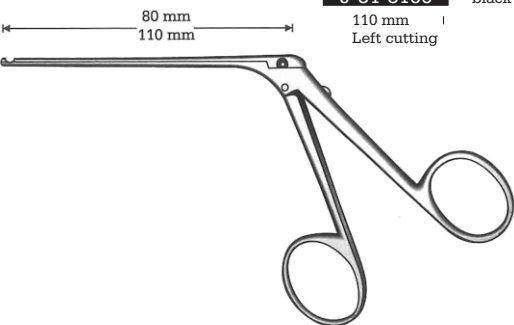
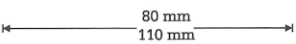

House-Dieter
 Malleus nipper



J-31-3180
J-31-3185 Black finish
 80 mm

J-31-3181
J-31-3186 Black finish
 110 mm
 For teflon prosthesis

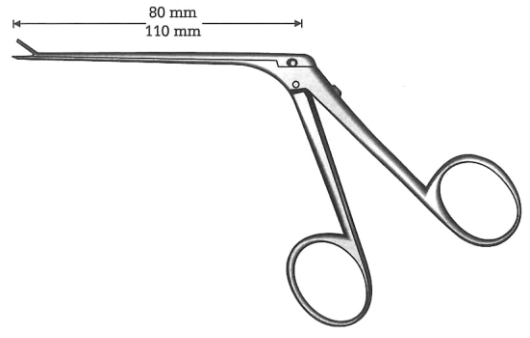
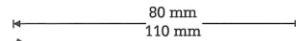



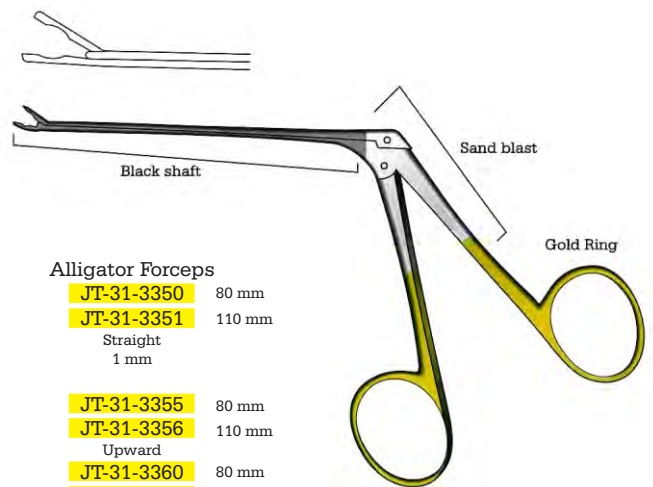
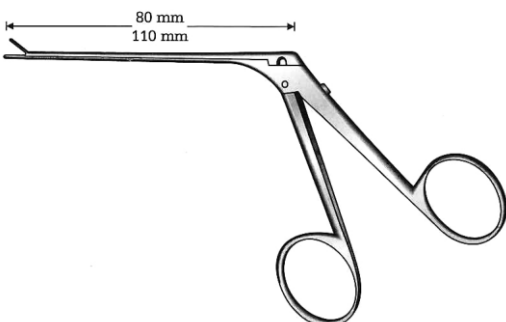
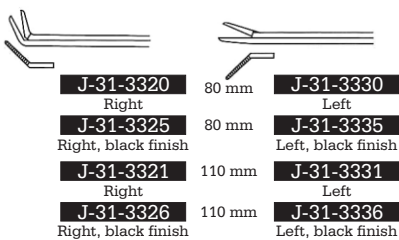
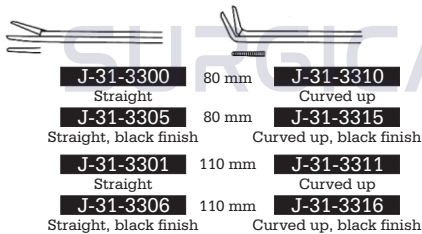
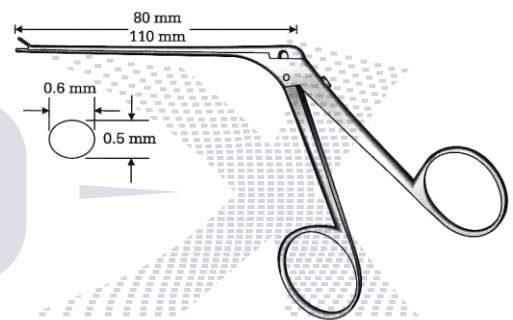
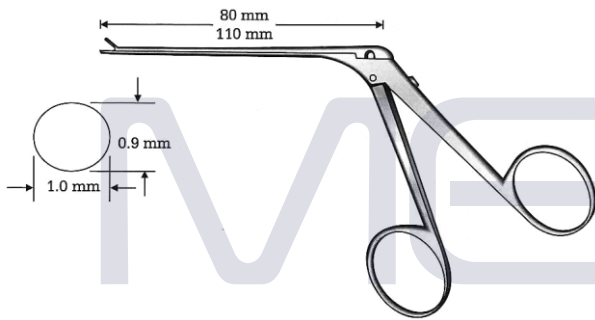
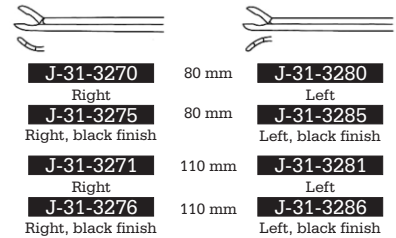
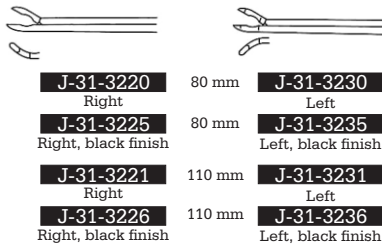
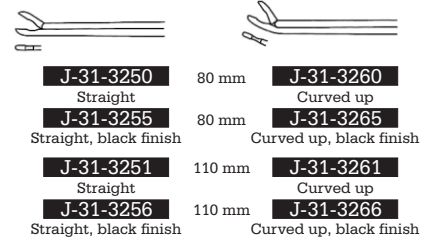
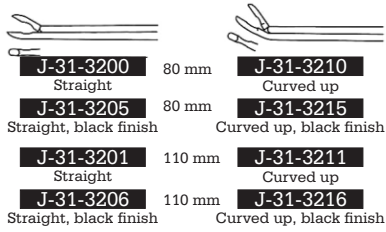



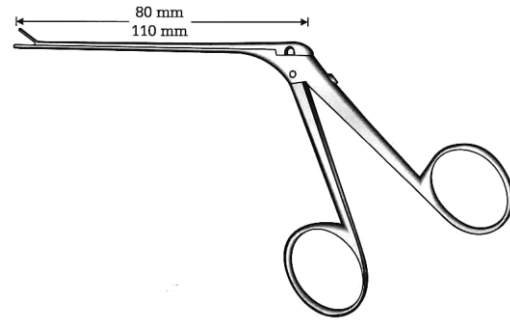

Fuller
 Introducing forceps









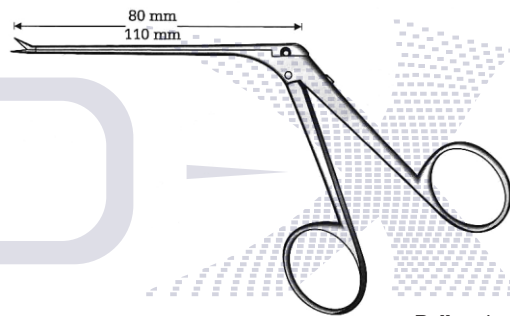
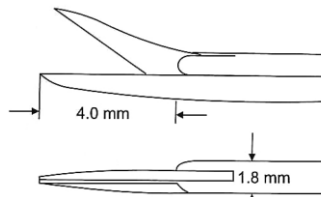

Alligator Forceps
Delicate, Gold Ring
Tip 1 mm

-  **J-31-3370** Straight
-  **J-31-3375** Straight, black finish
80 mm
-  **J-31-3371** Straight
-  **J-31-3376** Straight, black finish
110 mm
4.0 x 0.6 mm











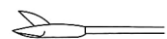
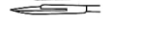





-  **J-31-3400** Straight
-  **J-31-3405** Straight, black finish
80 mm
-  **J-31-3401** Straight
-  **J-31-3406** Straight, black finish
110 mm
-  **J-31-3410** Curved up
-  **J-31-3415** Curved up, black finish
80 mm
-  **J-31-3411** Curved up
-  **J-31-3416** Curved up, black finish
110 mm



-  **J-31-3420** Right
-  **J-31-3425** Right, black finish
80 mm
-  **J-31-3421** Right
-  **J-31-3426** Right, black finish
110 mm
-  **J-31-3430** Left
-  **J-31-3435** Left, black finish
80 mm
-  **J-31-3431** Left
-  **J-31-3436** Left, black finish
110 mm

Bellucci
 Very delicate

-  **J-31-3450** Straight
-  **J-31-3455** Straight, black finish
80 mm
-  **J-31-3451** Straight
-  **J-31-3456** Straight, black finish
110 mm
-  **J-31-3460** Curved up
-  **J-31-3465** Curved up, black finish
80 mm
-  **J-31-3461** Curved up
-  **J-31-3466** Curved up, black finish
110 mm
-  **J-31-3470** Right
-  **J-31-3475** Right, black finish
80 mm
-  **J-31-3471** Right
-  **J-31-3476** Right, black finish
110 mm
-  **J-31-3480** Left
-  **J-31-3485** Left, black finish
80 mm
-  **J-31-3481** Left
-  **J-31-3486** Left, black finish
110 mm

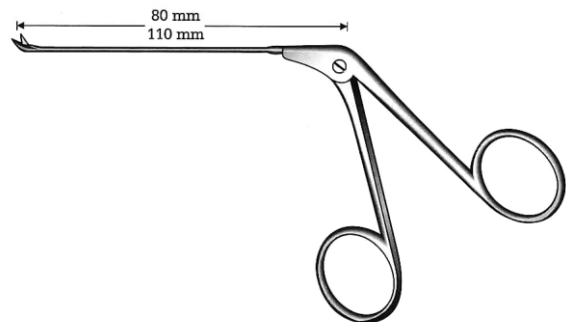
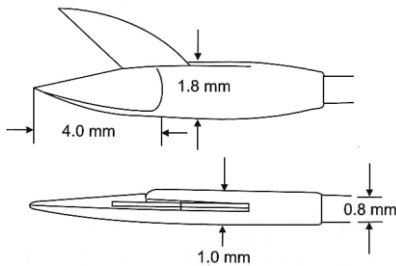

Wullstein

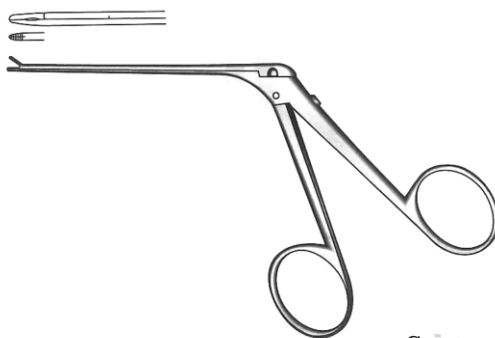

Greven
J-31-1385

MED  SURGICAL DISTRIBUTION

2 mm

3 mm



Citelli
J-31-1386 2 mm
J-31-1387 3 mm

2 mm

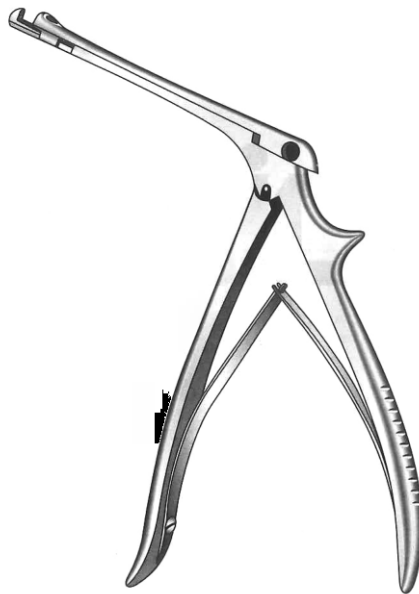

Beyer
J-31-1388

1 mm

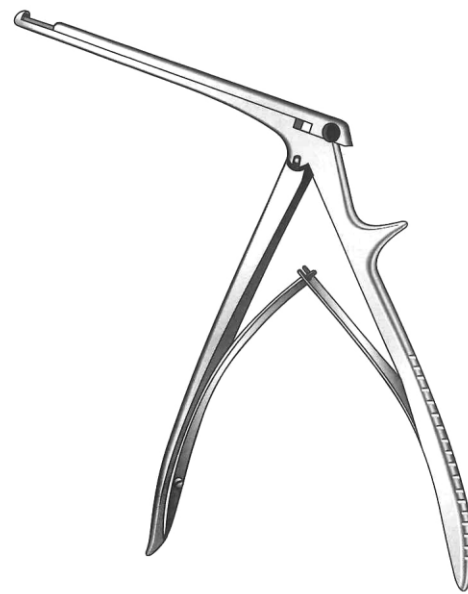

Beyer
J-31-1389

ENT & Plastic Surgery
Instruments



Suction Tubes

Suction Tubes



J-14-041	1.5 mm ϕ
J-14-042	2.0 mm ϕ
J-14-043	2.5 mm ϕ
J-14-044	3.5 mm ϕ

J-14-045	1.5 mm ϕ
J-14-046	2.0 mm ϕ
J-14-047	2.5 mm ϕ
J-14-048	3.5 mm ϕ
With additional side holes	

Adson
J-14-049
21 cm / 8½"
4 mm ϕ

Frazier	
Fr.	mm
J-14-050	06 2
J-14-250	07 2.3
J-14-051	08 2.6
J-14-251	09 3
J-14-052	10 3.3
J-14-252	11 3.6
J-14-053	12 4
J-14-253	14 4.6
J-14-254	16 5
19 cm / 7½"	

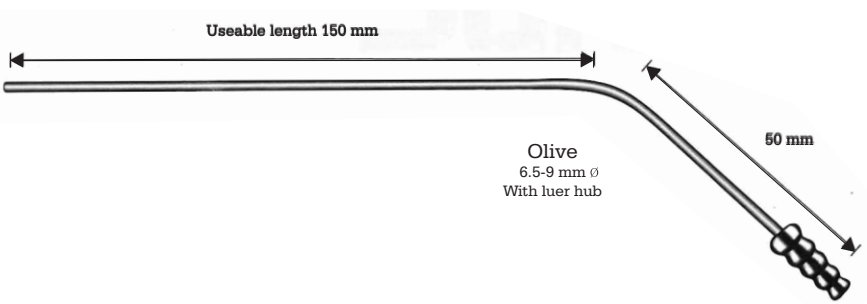

Yasargil	
J-14-054	150 mm x 1.5 mm
J-14-055	150 mm x 2.0 mm
J-14-057	150 mm x 2.5 mm
J-14-058	150 mm x 3.5 mm
11 cm / 4¼"	

Frazier
J-14-260
9 Fr. 3 mm



Frazier	Fr.	
J-14-130	6	2 mm
J-14-131	7	2.3 mm
J-14-132	8	2.6 mm
J-14-133	9	3 mm
J-14-134	10	3.3 mm
J-14-135	11	3.6 mm
J-14-136	12	4 mm
J-14-137	14	4.6 mm
J-14-138	16	5 mm

Ear suction tube

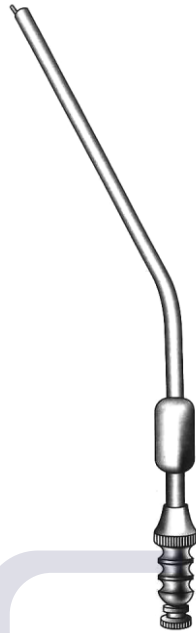

Frazier	Fr.	
J-14-140	6	2 mm
J-14-141	7	2.3 mm
J-14-142	8	2.6 mm
J-14-143	9	3 mm
J-14-144	10	3.3 mm
J-14-145	11	3.6 mm
J-14-146	12	4 mm
J-14-147	14	4.6 mm
J-14-148	16	5 mm



Unit Auditive	Inside	Outside
J-14-150	1 mm	2 mm
J-14-151	1.2 mm	2.2 mm
J-14-152	1.5 mm	2.5 mm
J-14-153	2 mm	3 mm

14.5 cm / 5 3/4"

SURGICAL DISTRIBUTION

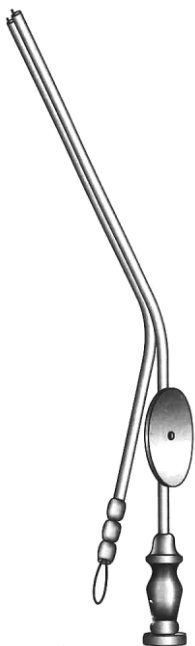

House Suction Irrigating Tubes	
J-14-160	5 French
J-14-161	7 French
J-14-162	8 French
J-14-163	10 French
J-14-164	12 French
J-14-165	14 French

Ear suction tube



Baron	
J-14-170	3 French
J-14-171	5 French
J-14-172	7 French with finger cut off

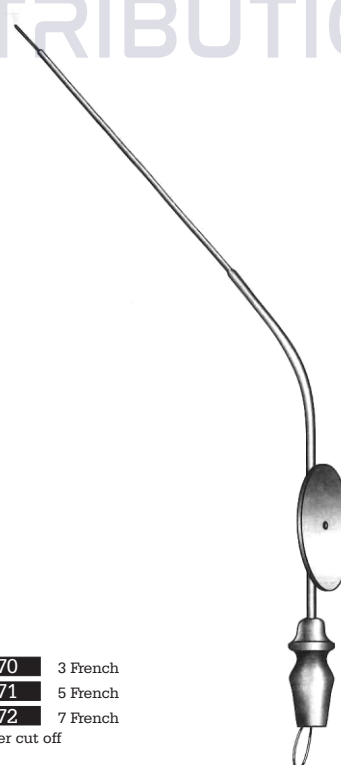

Baron	
J-14-180	3 French
J-14-185	5 French
J-14-190	7 French

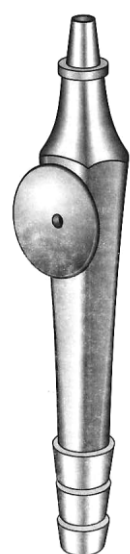
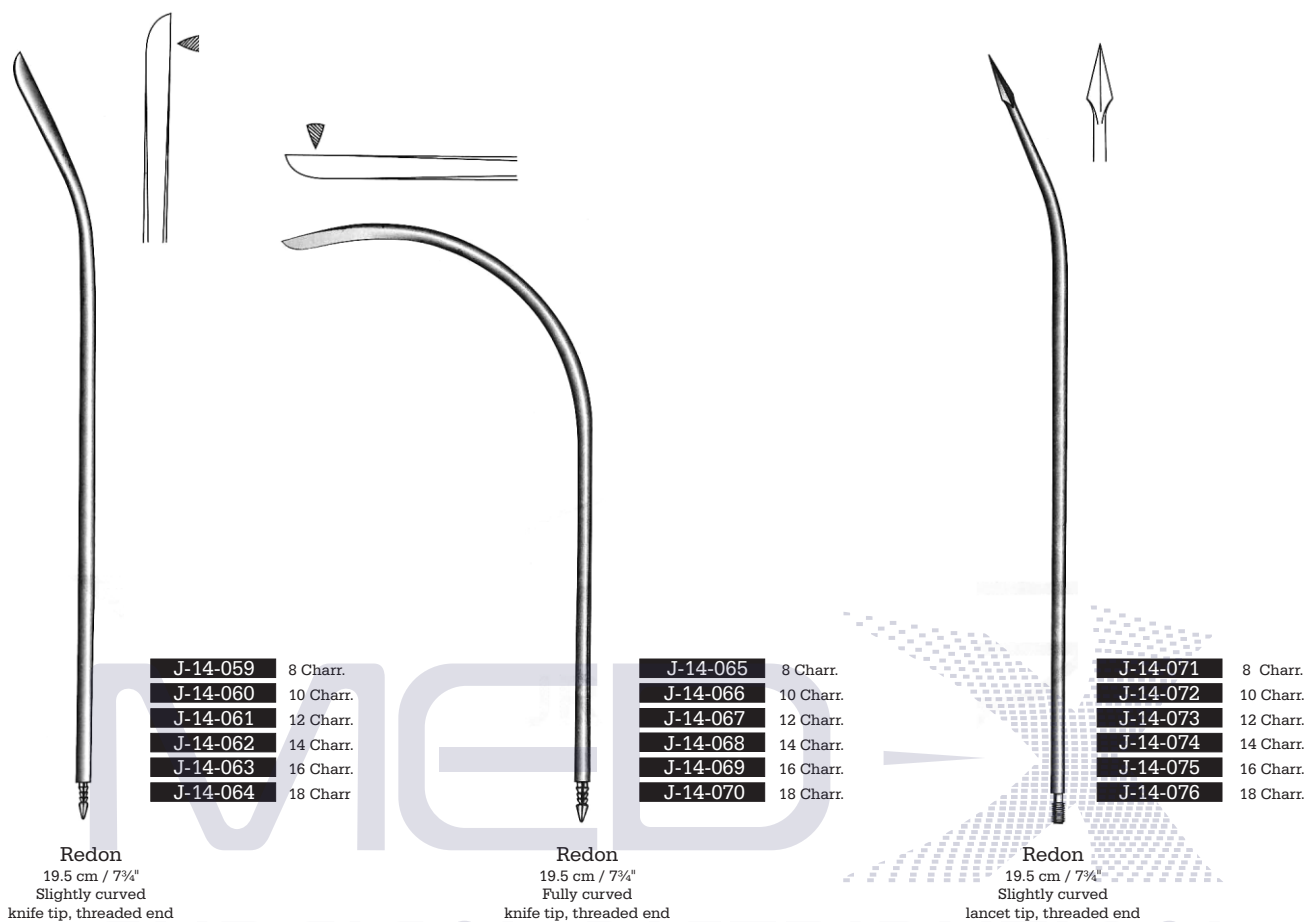

Suction Adapter
J-14-315



Suction Tube
J-14-330
Fig. 1



Suction Tube
J-14-331
Fig. 2



Suction Tube
J-14-332
Fig. 3



Suction Tube
J-14-333
Fig. 4



Suction Tube
J-14-334
Fig. 5

ENT & Plastic Surgery Instruments



Rhinology, Esophagoscopy, Maxio Facial

Rhinology
Esophagoscopy
Maxio Facial



J-32-200
Fig. 0

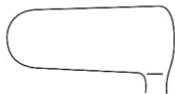

J-32-210
Fig. 1



J-32-220
Fig. 2



J-32-230
Fig. 3

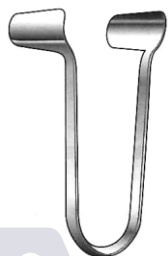

Goldsmith Thudichum

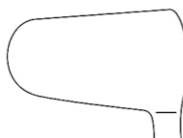

J-32-240
Fig. 4

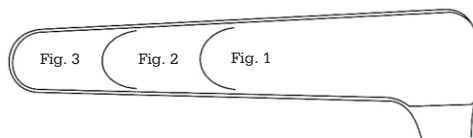
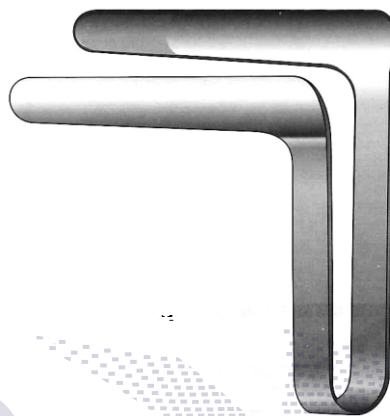

Fig. 3

Fig. 2

Fig. 1



St. Clair Thomson

- J-32-250** Fig. 1, 35 mm
- J-32-260** Fig. 2, 50 mm
- J-32-270** Fig. 3, 75 mm

MED SURGICAL DISTRIBUTION



J-32-160
Fig. 1

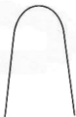

J-32-170
Fig. 2



J-32-180
Fig. 3



Voltolini

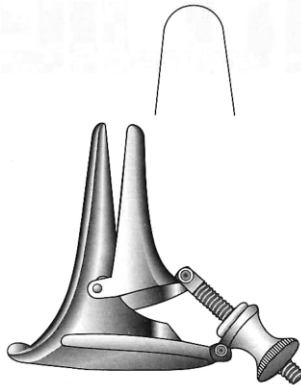

Vacher
J-32-190

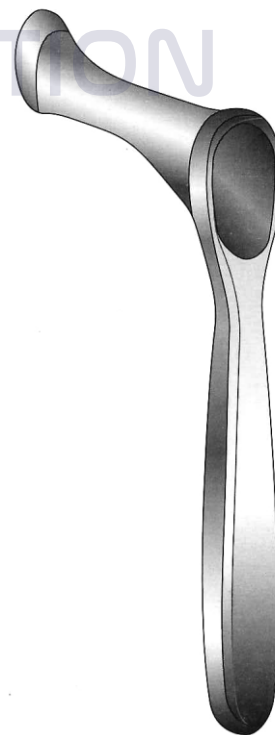

Yankauer
J-32-280
19 cm / 7½"

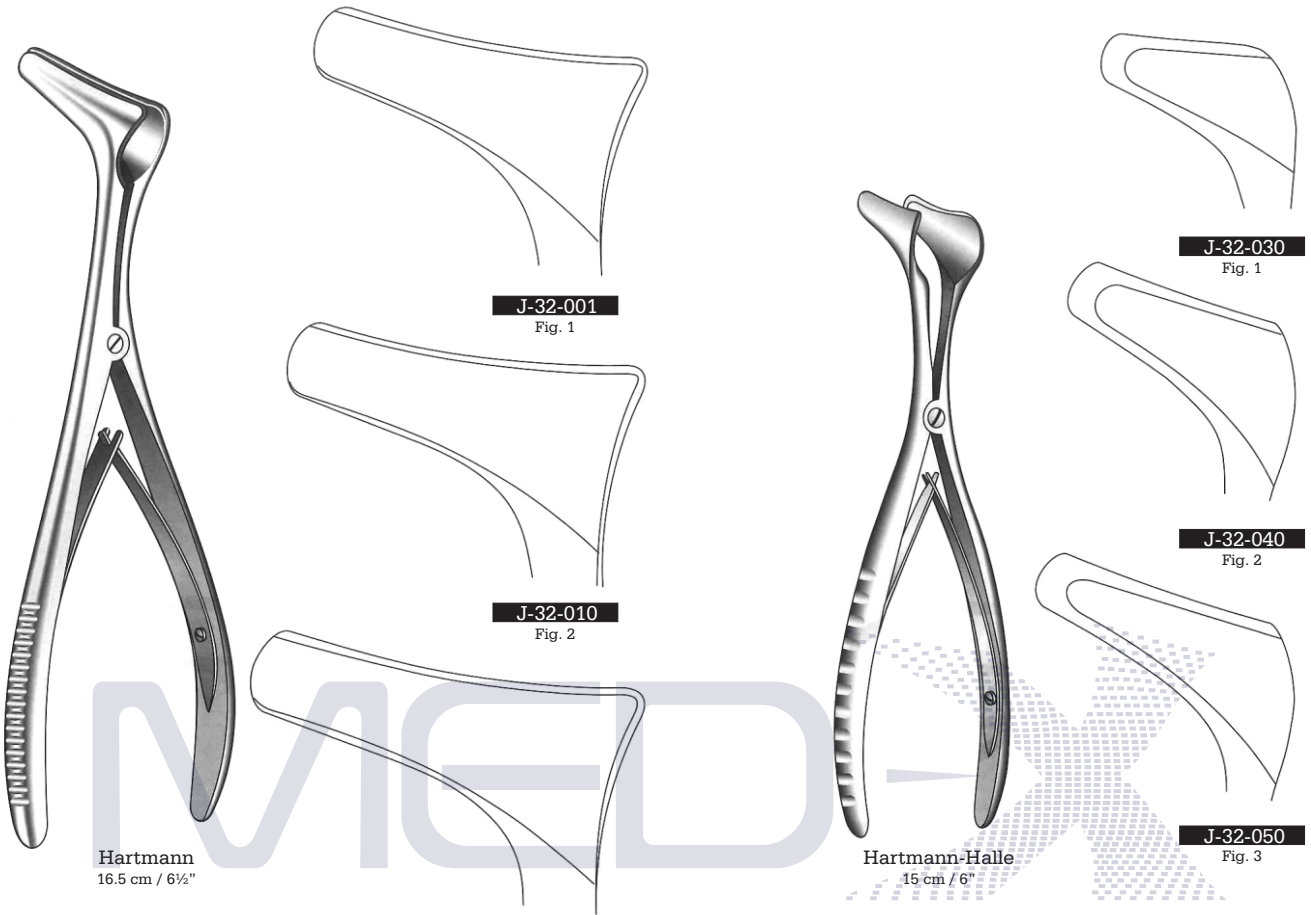

SURGICAL DISTRIBUTION

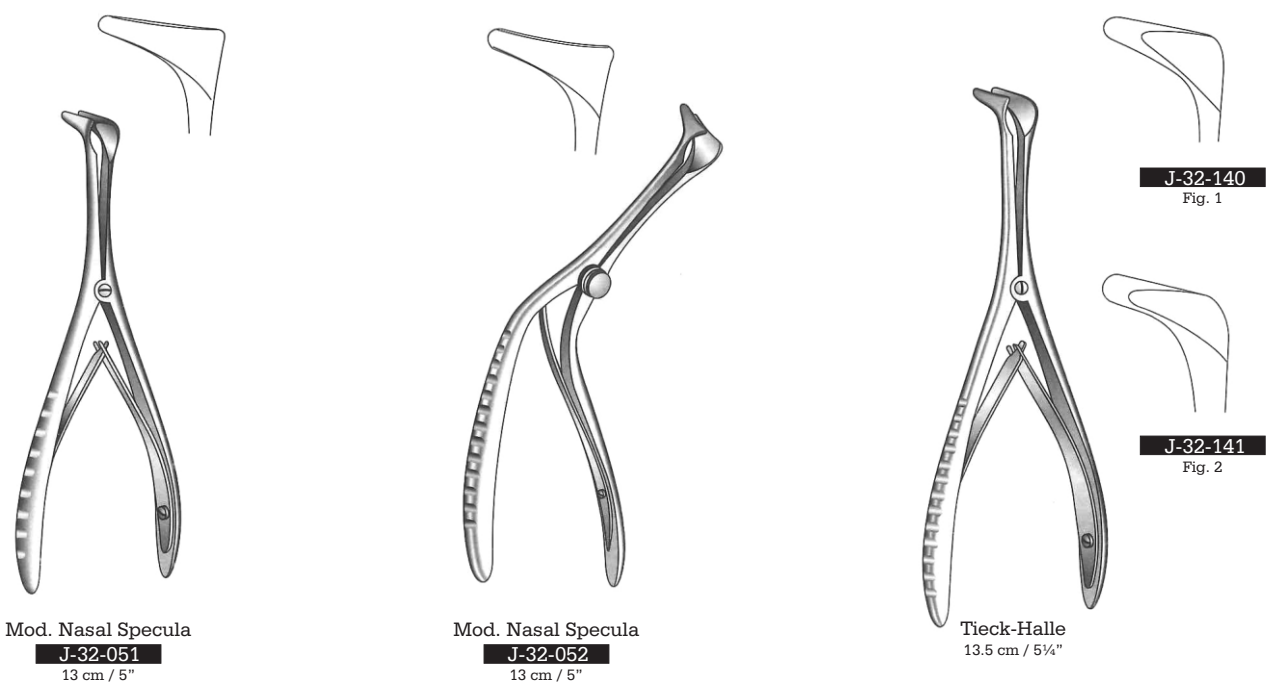

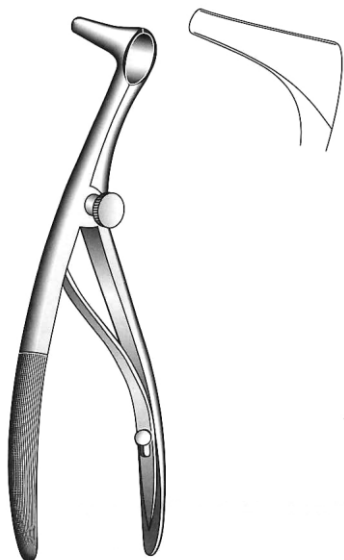

Beckman
J-32-053
15 cm / 6"



Vienna
J-32-100 Infant
J-32-110 Child
J-32-120 Adult
J-32-125 Sheet
J-32-130 Metal
14.5 cm / 5½"

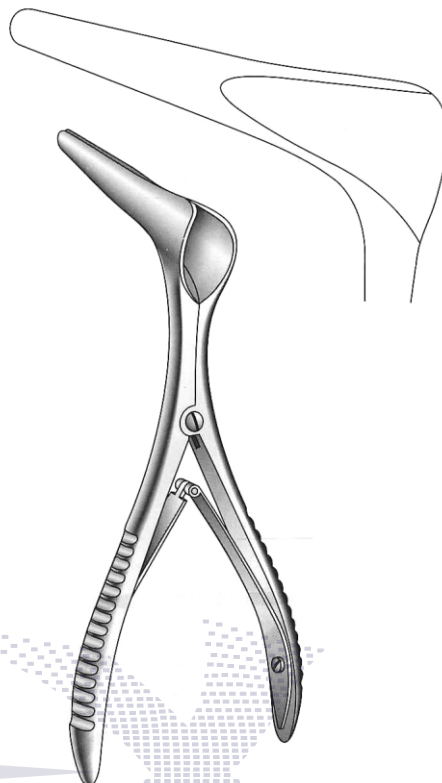

Cottle
J-32-5370
14 cm / 5½"

MEDICAL SURGICAL DISTRIBUTION

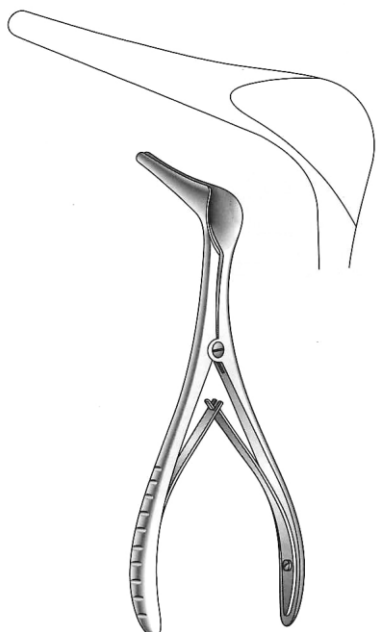

Cottle
J-32-5380
13 cm / 5½"



Dull black chrome plated



J-32-143

J-32-142



Killian
13 cm / 5"

J-32-3550	Standard	J-32-131
J-32-7140	With Fiber Optics	J-32-7141
Stainless Steel Finish		
J-32-7143	Standard	J-32-7145
J-32-7146	With Fiber Optics	J-32-7147
Black Finish		
J-32-7200	Standard	J-32-7201
J-32-7204	Black Finish	J-32-7205
Extra Thin Blades, Take Of Joint		
With Side Screw	Blade Size 35 mm	Without Side Screw

J-32-3552	Standard	J-32-3551
J-32-7149	With Fiber Optics	J-32-7150
Stainless Steel Finish		
J-32-7151	Standard	J-32-7153
J-32-7154	With Fiber Optics	J-32-7155
Black Finish		
J-32-7210	Standard	J-32-7211
J-32-7214	Black Finish	J-32-7215
Extra Thin Blades, Take Of Joint		
With Side Screw	Blade Size 40 mm	Without Side Screw

J-32-3553	Standard	J-32-132
J-32-7157	With Fiber Optics	J-32-7158
Stainless Steel Finish		
J-32-7159	Standard	J-32-7161
J-32-7162	With Fiber Optics	J-32-7163
Black Finish		
J-32-7220	Standard	J-32-7221
J-32-7224	Black Finish	J-32-7225
Extra Thin Blades, Take Of Joint		
With Side Screw	Blade Size 50 mm	Without Side Screw

J-32-7164	Standard	J-32-7165
J-32-7166	With Fiber Optics	J-32-7167
Stainless Steel Finish		
J-32-7168	Standard	J-32-7169
J-32-7170	With Fiber Optics	J-32-7171
Black Finish		
J-32-7230	Standard	J-32-7231
J-32-7234	Black Finish	J-32-7235
Extra Thin Blades, Take Of Joint		
With Side Screw	Blade Size 65 mm	Without Side Screw

J-32-3554	Standard	J-32-133
J-32-7173	With Fiber Optics	J-32-7174
Stainless Steel Finish		
J-32-7175	Standard	J-32-7177
J-32-7178	With Fiber Optics	J-32-7179
Black Finish		
J-32-7240	Standard	J-32-7241
J-32-7244	Black Finish	J-32-7245
Extra Thin Blades, Take Of Joint		
With Side Screw	Blade Size 75 mm	Without Side Screw

J-32-3555	Standard	J-32-134
J-32-7181	With Fiber Optics	J-32-7182
Stainless Steel Finish		
J-32-7183	Standard	J-32-7185
J-32-7186	With Fiber Optics	J-32-7187
Black Finish		
J-32-7250	Standard	J-32-7251
J-32-7254	Black Finish	J-32-7255
Extra Thin Blades, Take Of Joint		
With Side Screw	Blade Size 90 mm	Without Side Screw

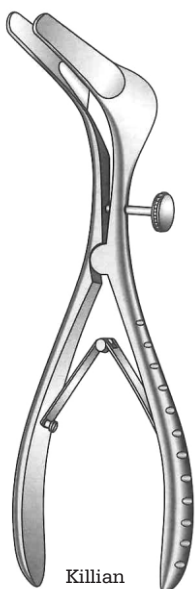
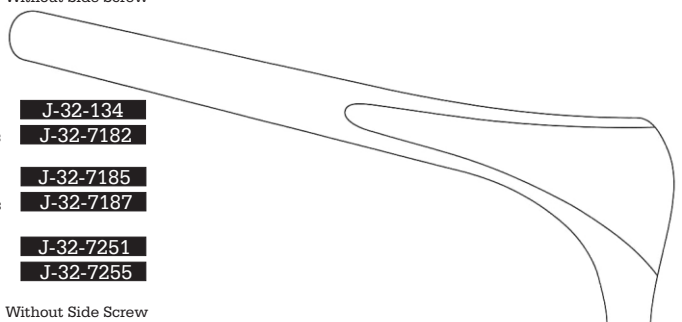
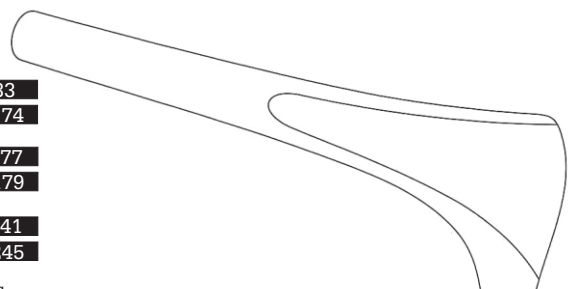
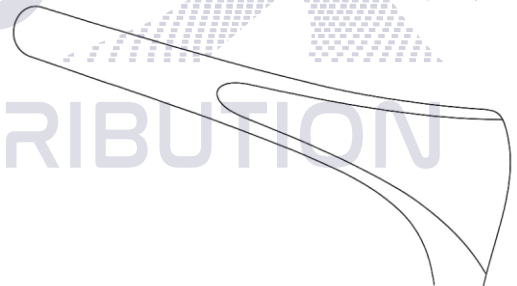
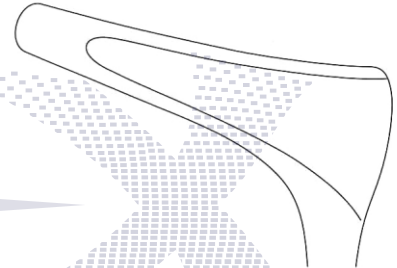
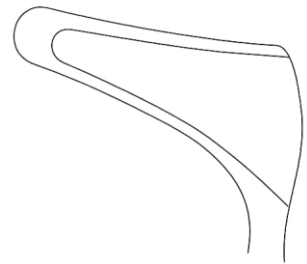
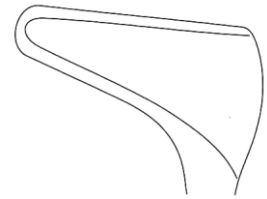

Killian
13 cm / 5"
Extra thin blades
Take of Joint



Cottle
14 cm / 5 1/2"
Extra thin blades

J-32-135	Standard	J-32-7001
J-32-7002	With Fiber Optics	J-32-7003
Stainless Steel Finish		
J-32-3560	Standard	J-32-7005
J-32-7006	With Fiber Optics	J-32-7007
Black Finish		
J-32-7300	Standard	J-32-7301
J-32-7304	Black Finish	J-32-7305
Extra Thin Blades, Take Of Joint		
With Side Screw	Blade Size 35 mm	Without Side Screw

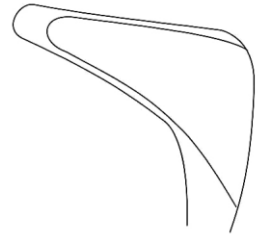

J-32-136	Standard	J-32-7009
J-32-7010	With Fiber Optics	J-32-7011
Stainless Steel Finish		
J-32-3561	Standard	J-32-7013
J-32-7014	With Fiber Optics	J-32-7015
Black Finish		
J-32-7320	Standard	J-32-7321
J-32-7324	Black Finish	J-32-7325
Extra Thin Blades, Take Of Joint		
With Side Screw	Blade Size 50 mm	Without Side Screw

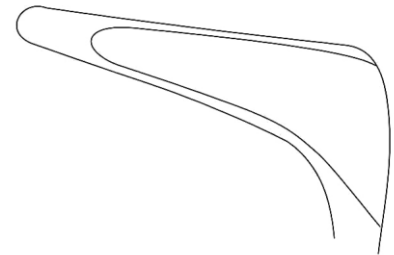

Cottle
14 cm / 5 1/2"
Extra thin blades
Black Finish

J-32-139	Standard	J-32-7017
J-32-7018	With Fiber Optics	J-32-7019
Stainless Steel Finish		
J-32-3562	Standard	J-32-7021
J-32-7022	With Fiber Optics	J-32-7023
Black Finish		
J-32-7330	Standard	J-32-7331
J-32-7334	Black Finish	J-32-7335
Extra Thin Blades, Take Of Joint		
With Side Screw	Blade Size 60 mm	Without Side Screw

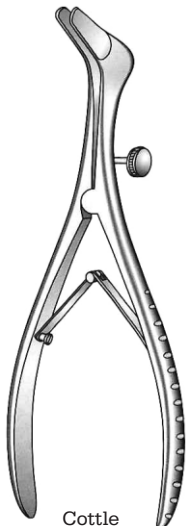

Cottle
14 cm / 5 1/2"
Extra thin blades
Take of Joint

J-32-137	Standard	J-32-7025
J-32-7026	With Fiber Optics	J-32-7027
Stainless Steel Finish		
J-32-3563	Standard	J-32-7029
J-32-7030	With Fiber Optics	J-32-7031
Black Finish		
J-32-7340	Standard	J-32-7341
J-32-7344	Black Finish	J-32-7345
Extra Thin Blades, Take Of Joint		
With Side Screw	Blade Size 75 mm	Without Side Screw

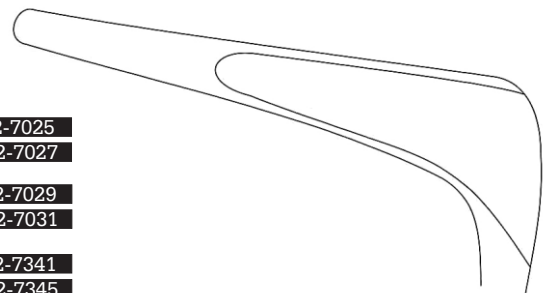

J-32-138	Standard	J-32-7033
J-32-7034	With Fiber Optics	J-32-7035
Stainless Steel Finish		
J-32-3564	Standard	J-32-7037
J-32-7038	With Fiber Optics	J-32-7039
Black Finish		
J-32-7350	Standard	J-32-7351
J-32-7354	Black Finish	J-32-7355
Extra Thin Blades, Take Of Joint		
With Side Screw	Blade Size 90 mm	Without Side Screw

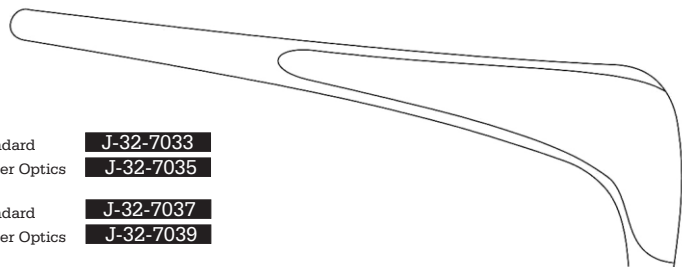



J-32-144
 70 x 8.5 mm blade
 For adults

J-32-145
 80 x 8.5 mm blade
 For adults

J-32-146
 60 x 7.0 mm blade
 For children

J-32-147
 70 x 7.0 mm blade
 For children

Fiber Optics



Killian
J-32-5360 14 cm / 5"
J-32-5361 18 cm / 7"
J-32-5362 23 cm / 9"



Killian
J-32-5363 14 cm / 5"
J-32-5364 18 cm / 7"
J-32-5365 23 cm / 9"
 with Fiber Optics



Tessier
 17 cm / 6 3/4"
 For dilation, black chromium plated



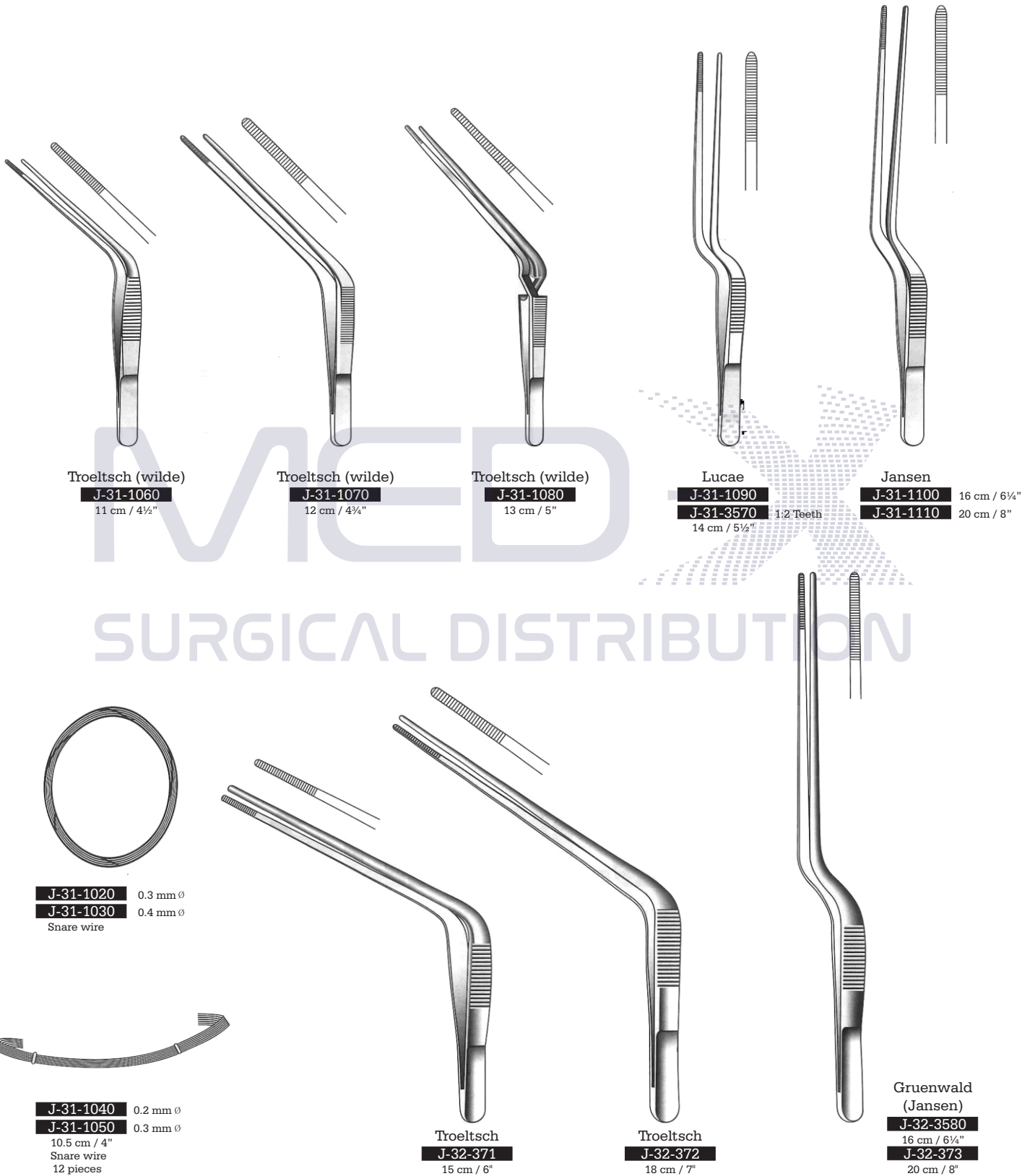

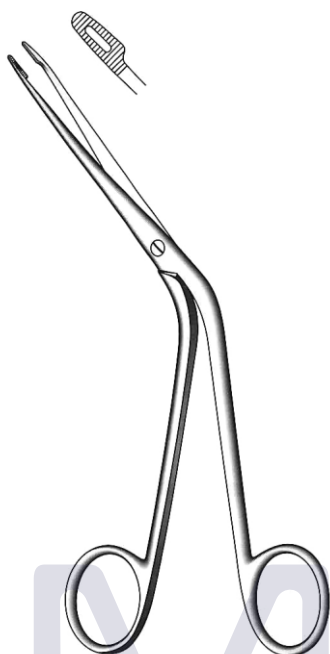

Hartmann
J-32-374
18 cm / 7"

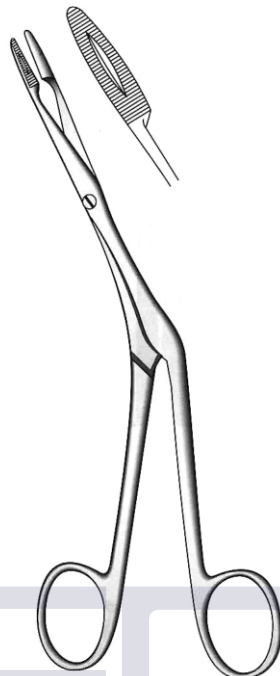

Heymann-Knight
J-32-375
18 cm / 7"

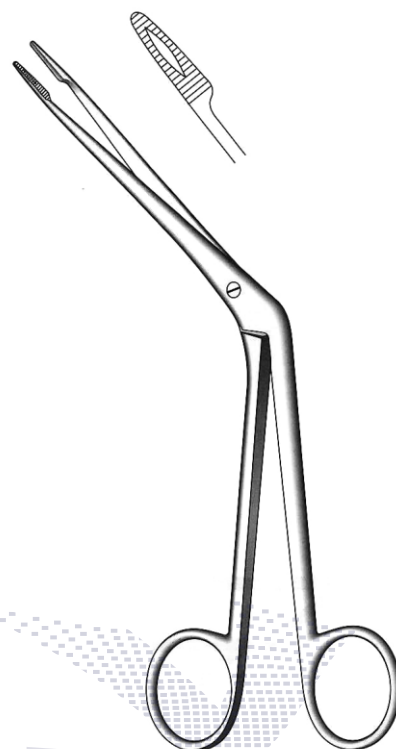

Hartmann
J-32-376
20 cm / 8"

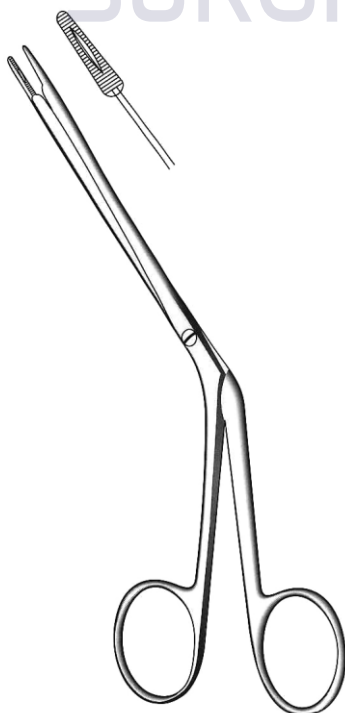

Littauer
J-32-377
18 cm / 7"

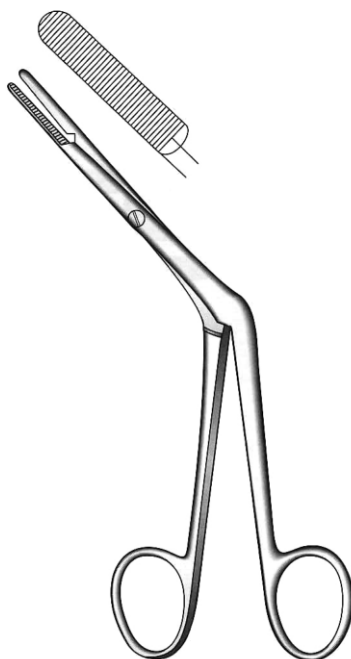

Killian
J-32-378
17 cm / 6 3/4"

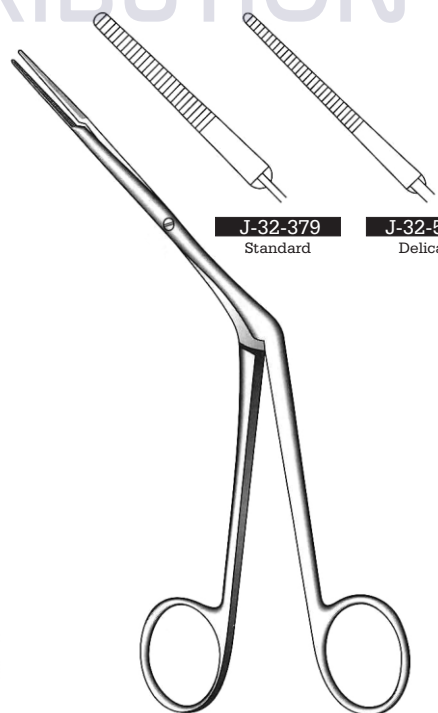

J-32-379 Standard
J-32-5550 Delicate

Westmacott
20 cm / 8"

SURGICAL DISTRIBUTION

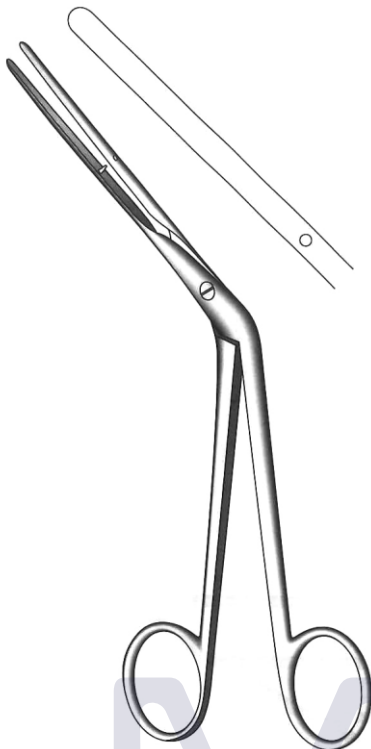

Lubet-Barbon
J-32-382
 20 cm / 8"
 Nasal tampon forceps

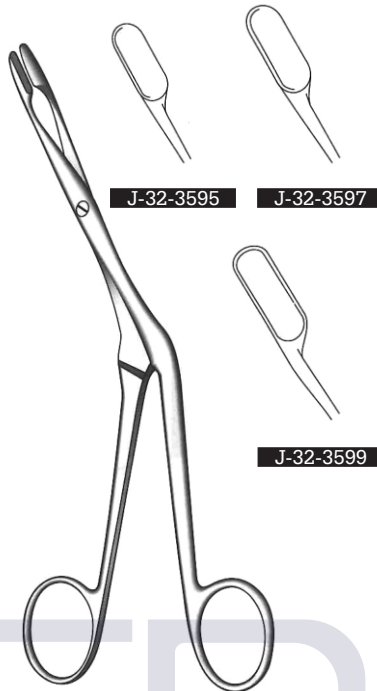

J-32-3595 **J-32-3597**

J-32-3599

Heymann
 18 cm / 7"

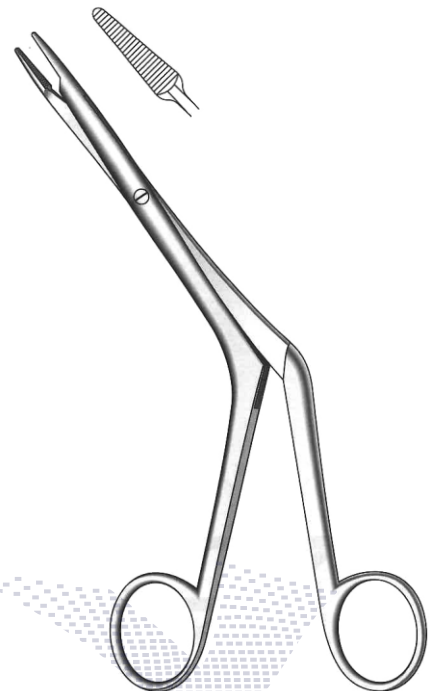

Heymann
J-32-5560
 18 cm / 7"

SURGICAL DISTRIBUTION

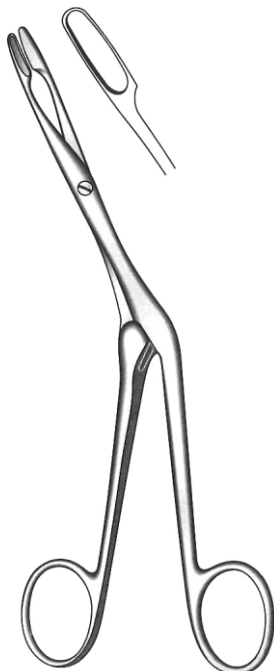

Knight
J-32-383
 18 cm / 7"

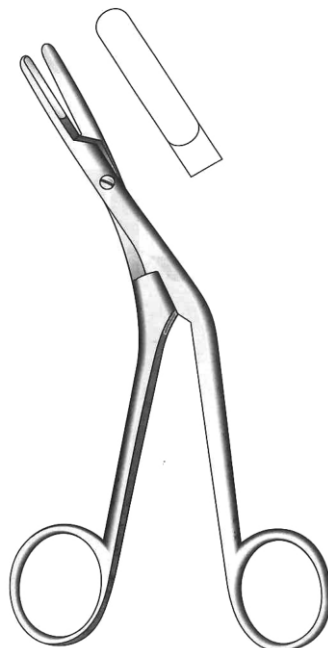

Graig
J-32-385
 18 cm / 7"

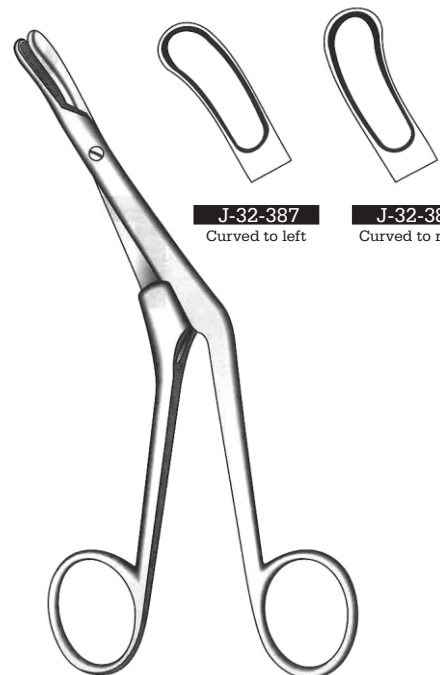

J-32-387
 Curved to left

J-32-386
 Curved to right

Craig-Domnick
 18 cm / 7"

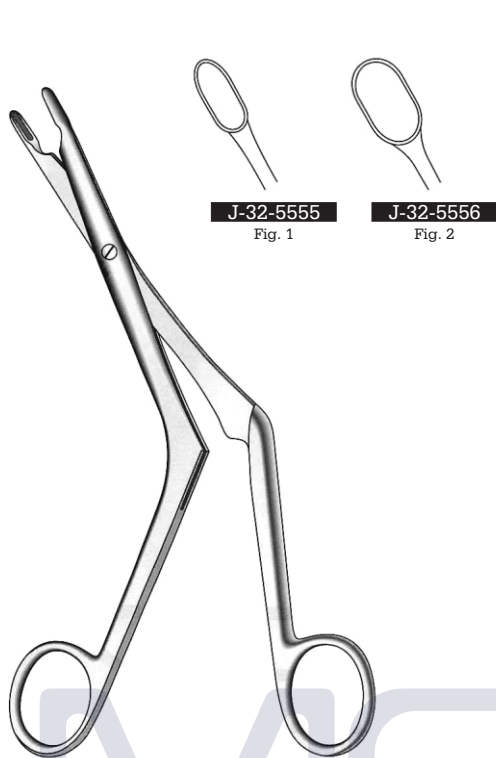

Luc-Brünings (Heymann)
18 cm / 7"

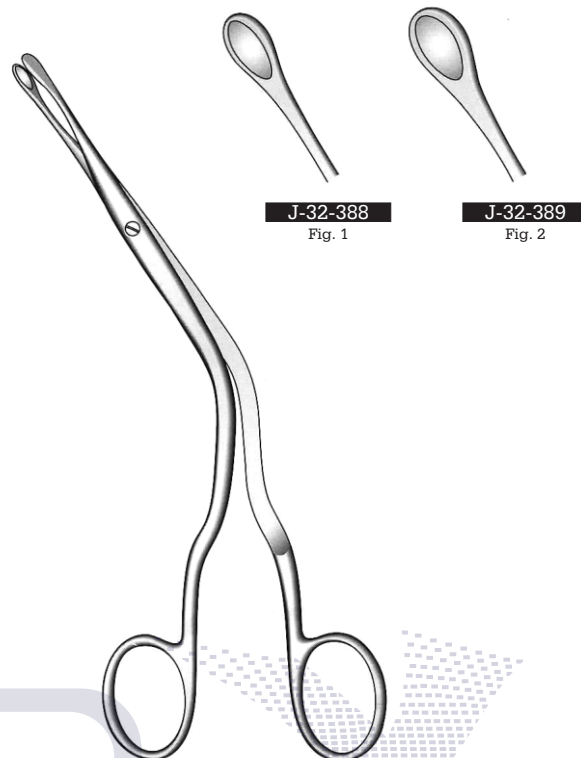

Luc
20 cm / 8"

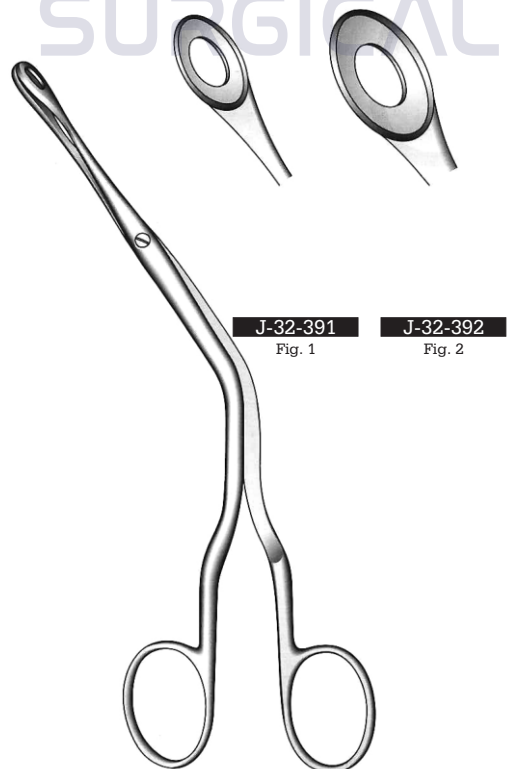

Luc
20 cm / 8"

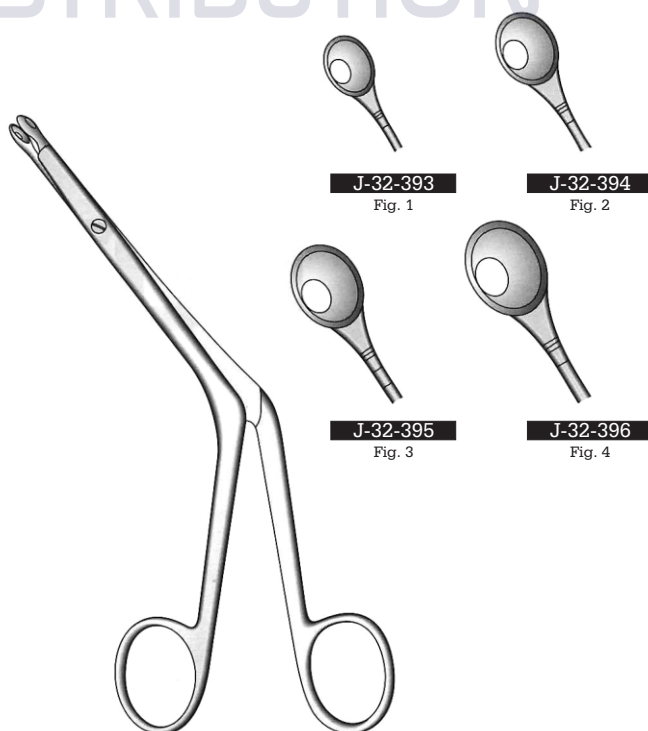

Bruenings
19 cm / 7½"

MEDICAL
SURGICAL DISTRIBUTION

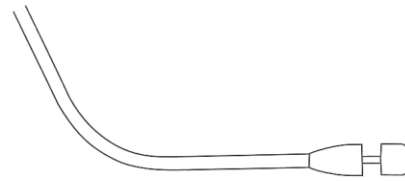

J-32-928

65° Curved Upwards, Cutting in a full circle of 360°

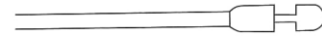

J-32-929

Straight, Cutting in a full circle of 360°

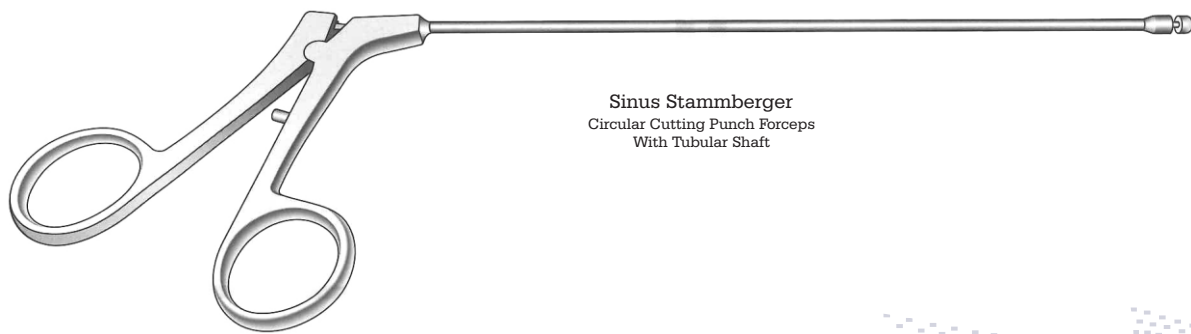

Sinus Stammberger
 Circular Cutting Punch Forceps
 With Tubular Shaft

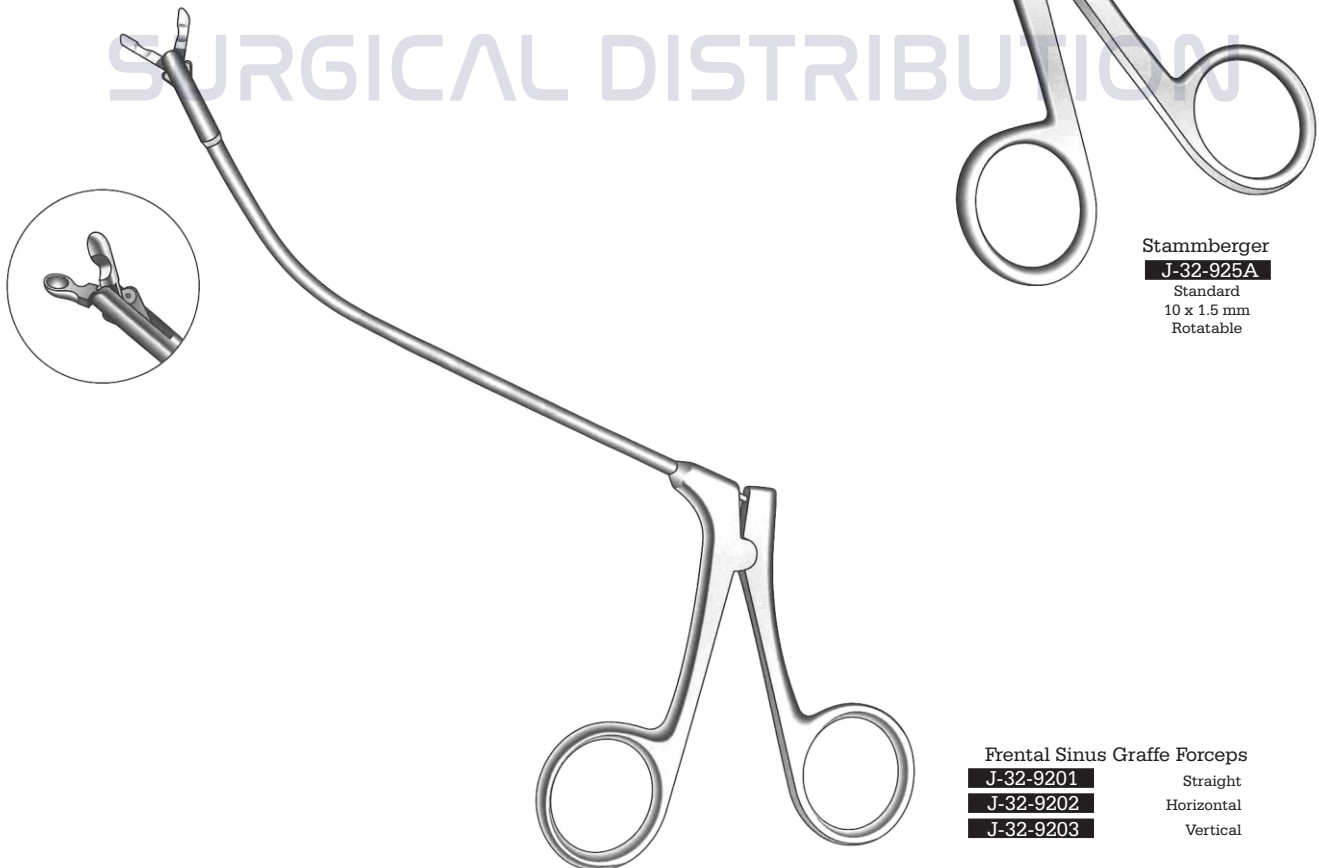

Stammberger
J-32-925A
 Standard
 10 x 1.5 mm
 Rotatable

Frenal Sinus Graffe Forceps
J-32-9201 Straight
J-32-9202 Horizontal
J-32-9203 Vertical

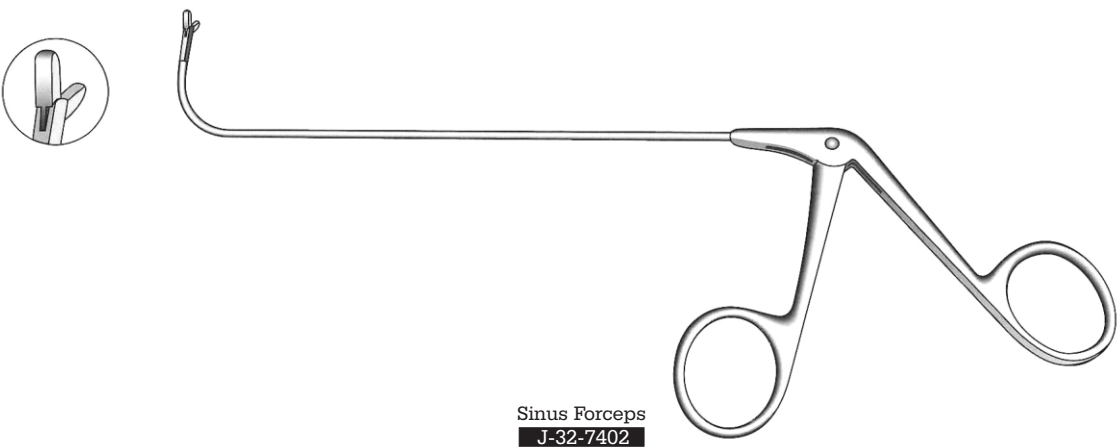
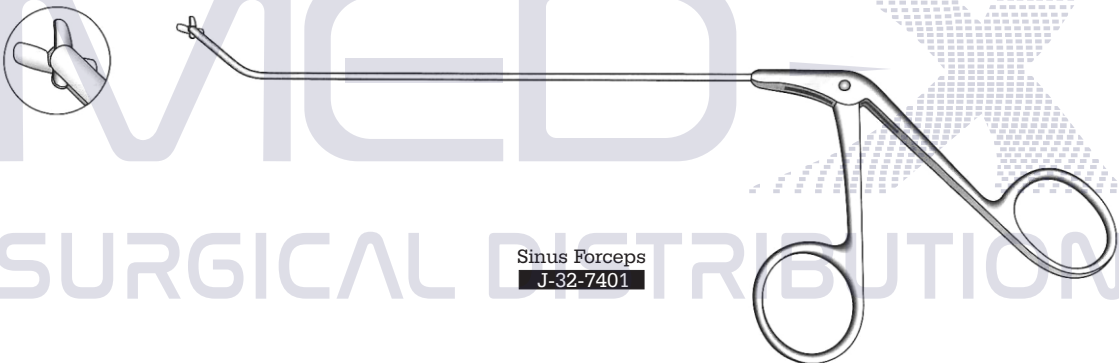
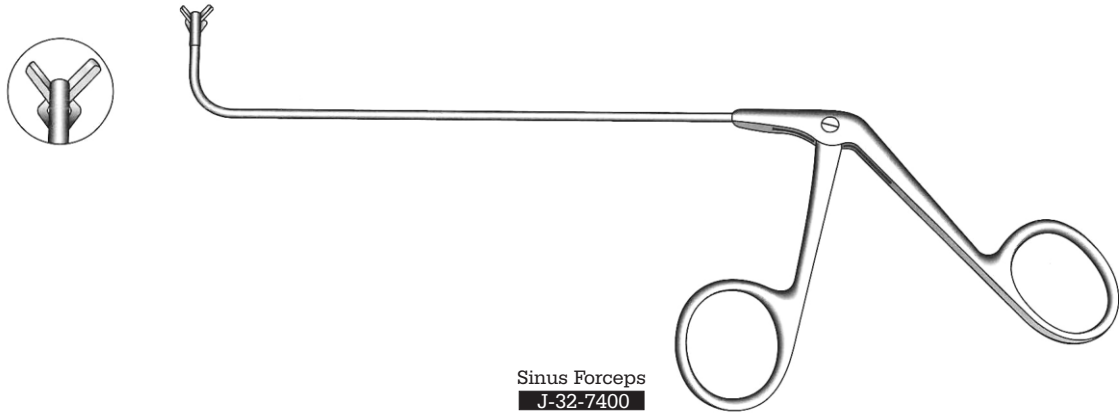

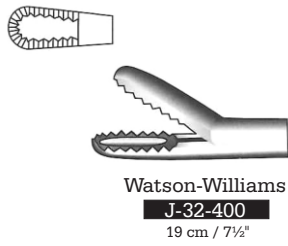

Watson-Williams
J-32-400
 19 cm / 7½"

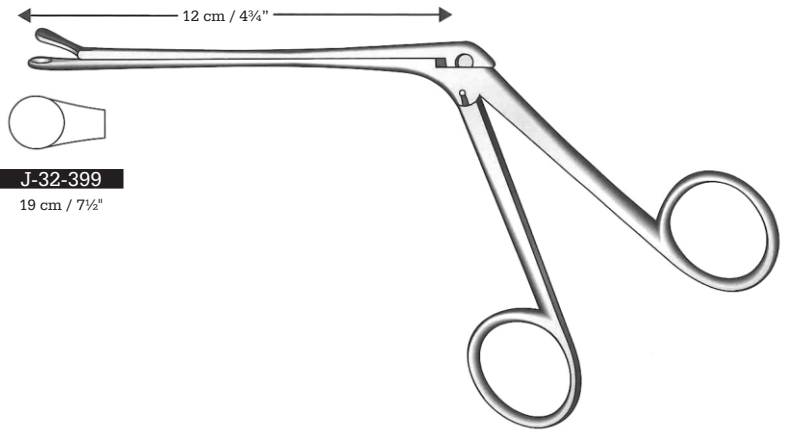

J-32-399
 19 cm / 7½"

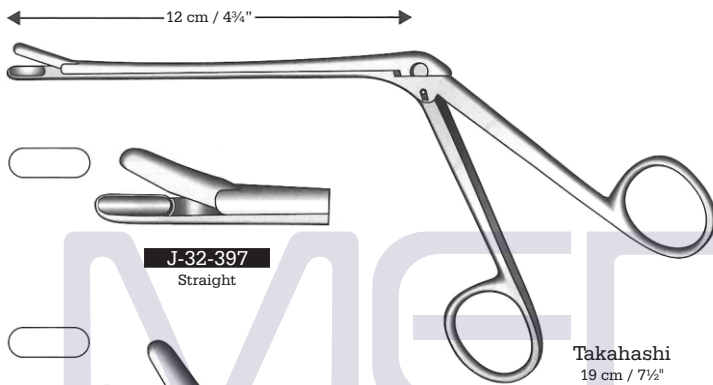

J-32-397
 Straight

Takahashi
 19 cm / 7½"



J-32-398
 Upward



Henckel
J-32-780
 20 cm / 8"

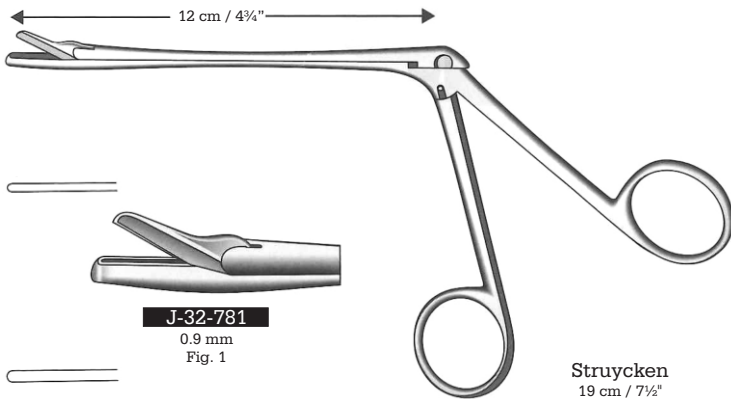

J-32-781
 0.9 mm
 Fig. 1

Struycken
 19 cm / 7½"

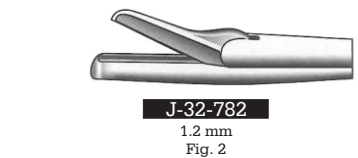

J-32-782
 1.2 mm
 Fig. 2

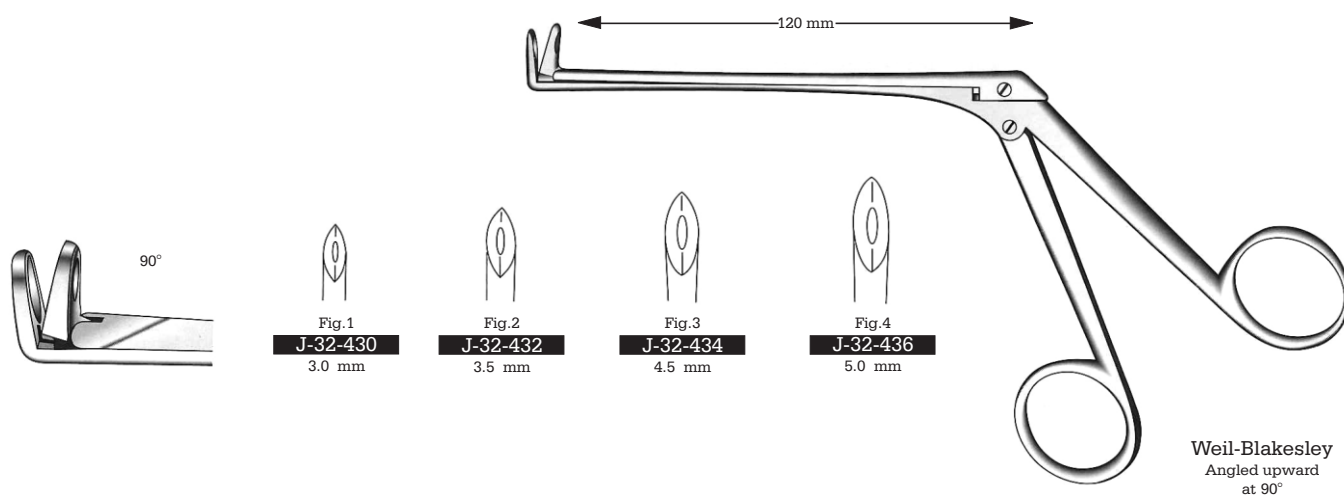
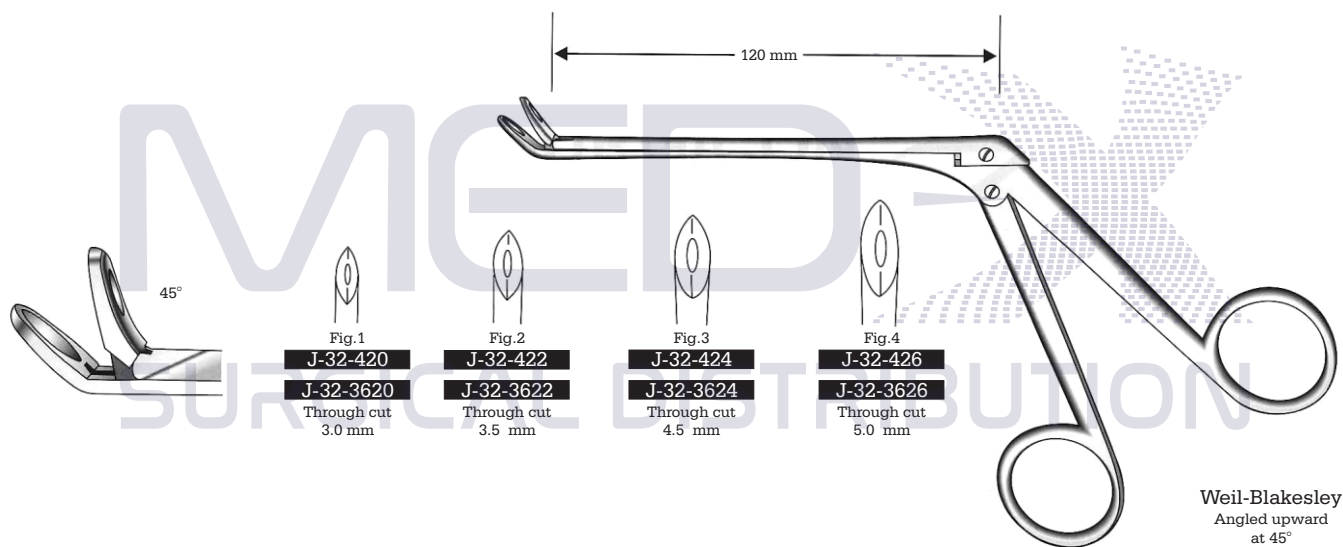
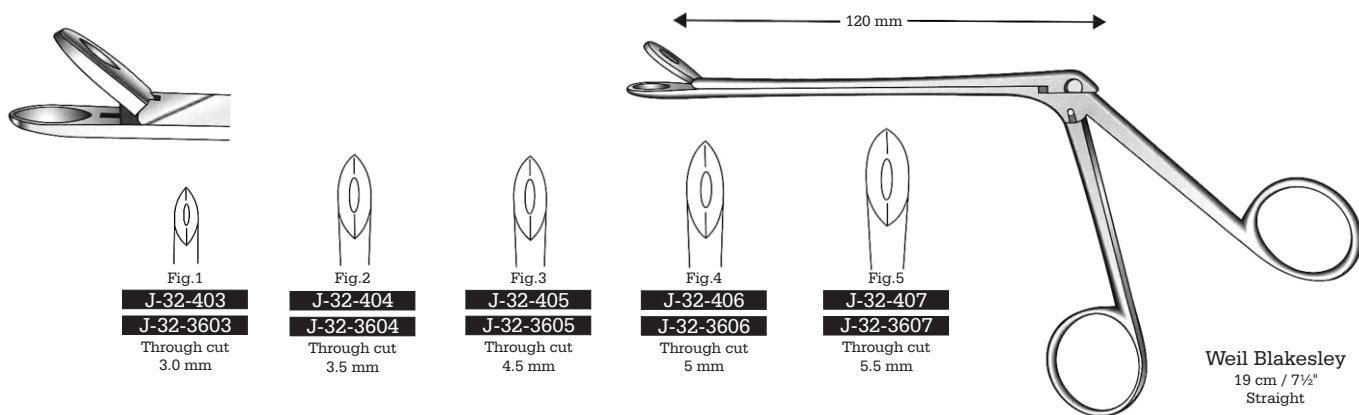

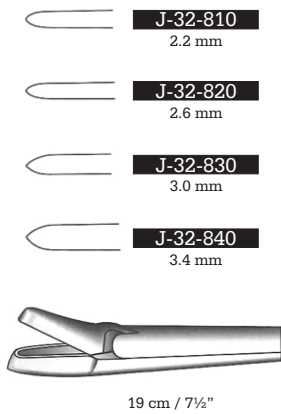

19 cm / 7 1/2"

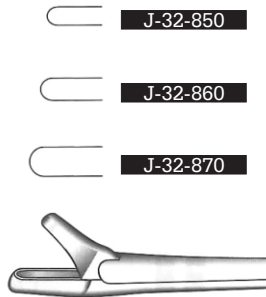

Myles
 19 cm / 7 1/2"
 Shaft 12 cm

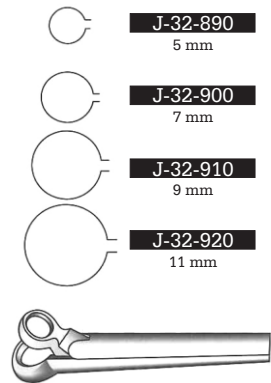

Hartmann
 19 cm / 7 1/2"
 Shaft 12 cm

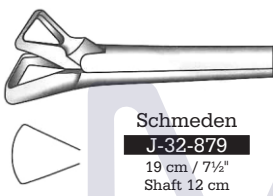

Schmeden
J-32-879
 19 cm / 7 1/2"
 Shaft 12 cm

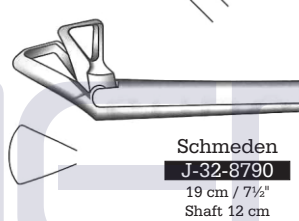

Schmeden
J-32-8790
 19 cm / 7 1/2"
 Shaft 12 cm

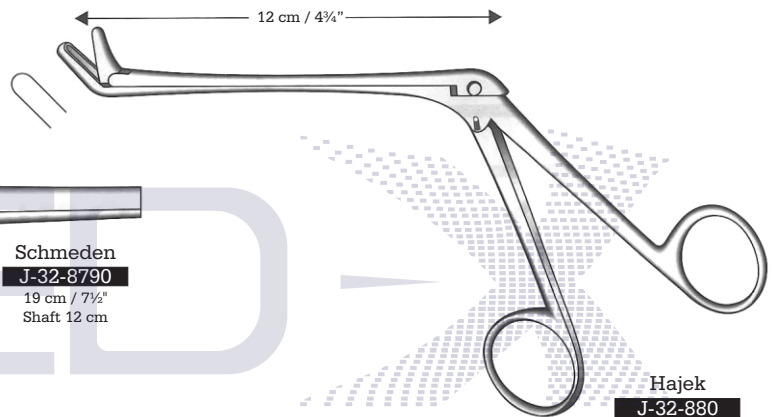

Hajek
J-32-880
 19 cm / 7 1/2"

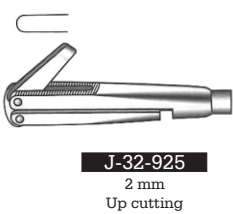

J-32-925
 2 mm
 Up cutting

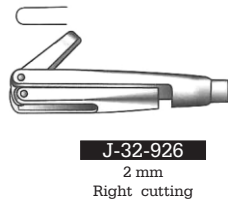

J-32-926
 2 mm
 Right cutting

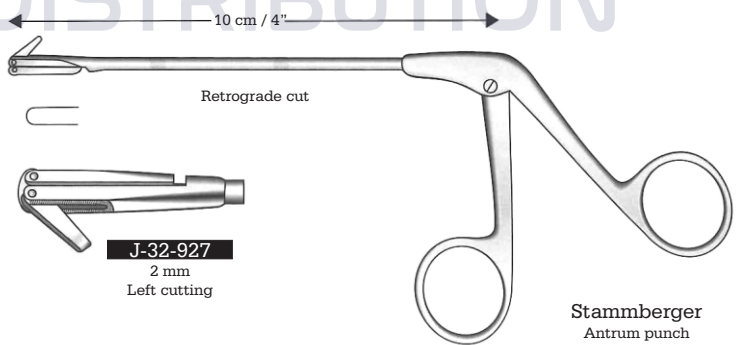

Retrograde cut

Stammburger
 Antrum punch

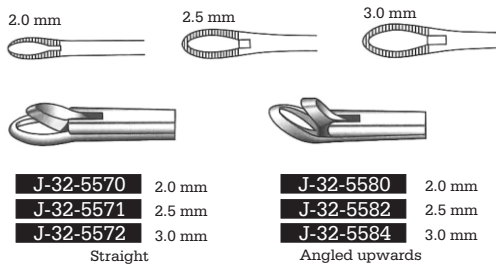

J-32-5570 2.0 mm
J-32-5571 2.5 mm
J-32-5572 3.0 mm
 Straight

J-32-5580 2.0 mm
J-32-5582 2.5 mm
J-32-5584 3.0 mm
 Angled upwards

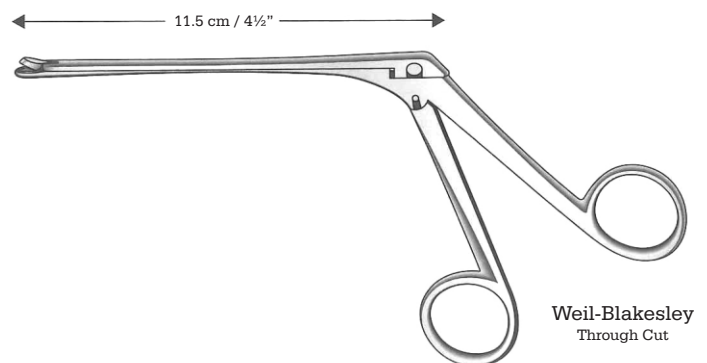

Weil-Blakesley
 Through Cut

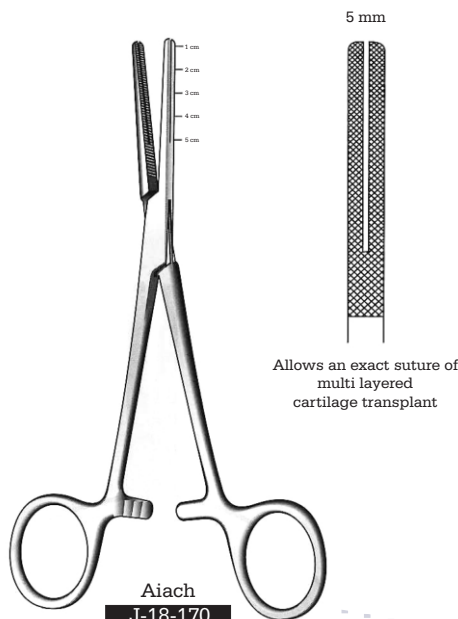

Aiach
J-18-170
16 cm / 6¼"
Forceps

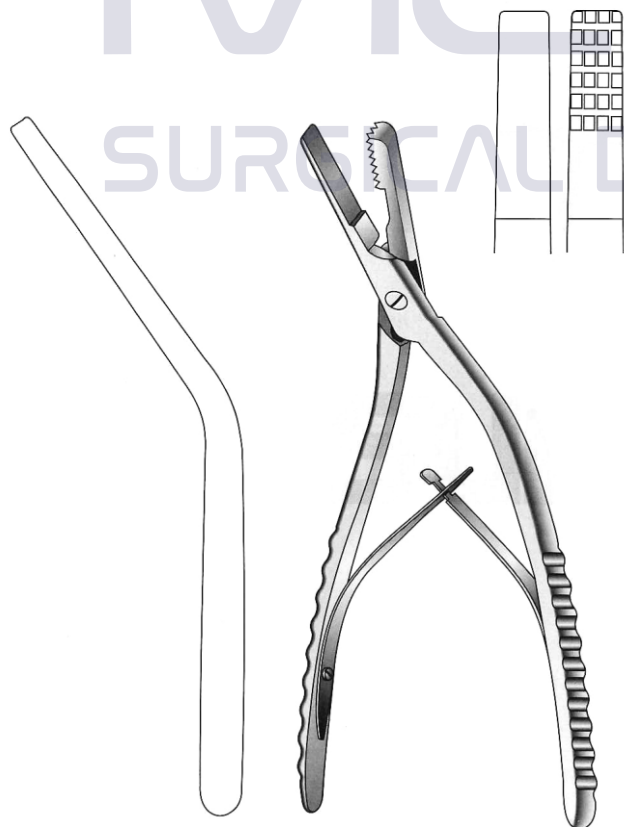

Obwegeser
J-32-5665
18.5 cm / 7¼"

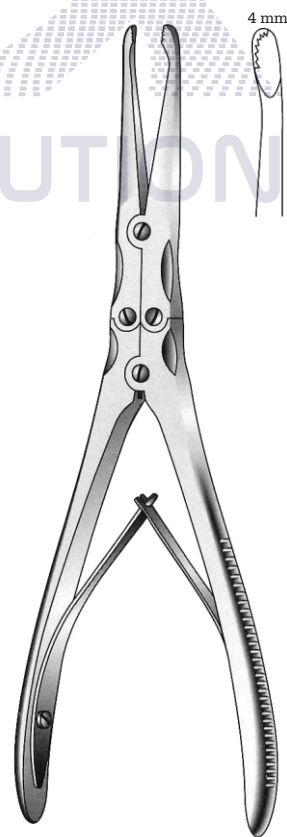

Obwegeser
J-32-5590
21 cm / 8¼"
Septum straightening forceps

MEDICAL DISTRIBUTION

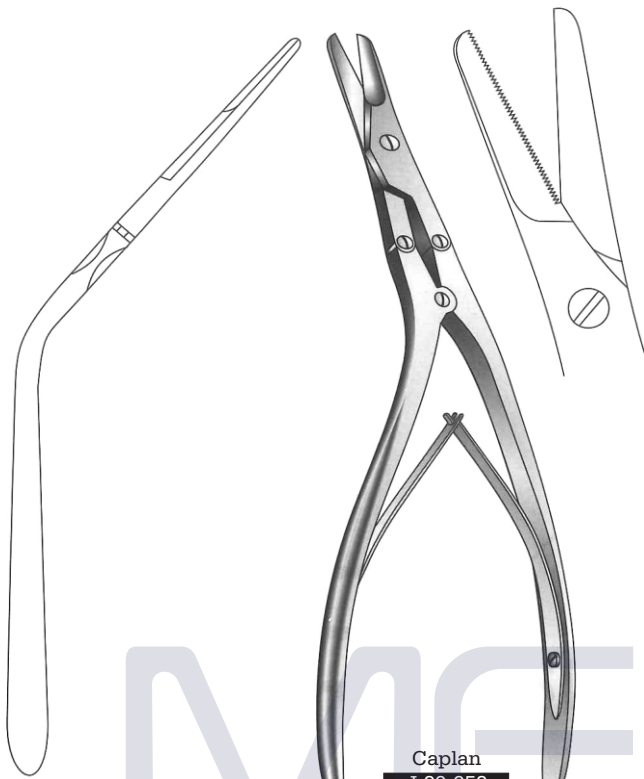

Caplan
J-32-953
20 cm / 8"

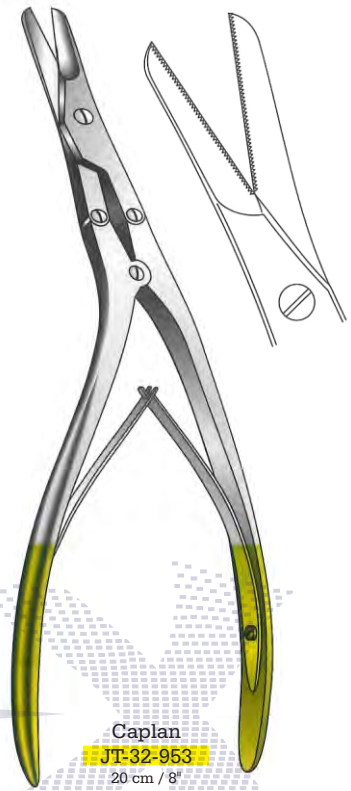

Caplan
JT-32-953
20 cm / 8"

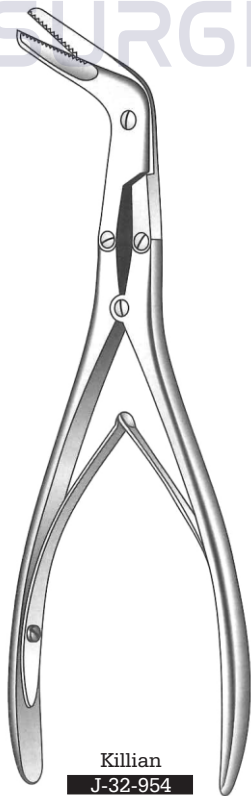

Killian
J-32-954
21 cm / 8½"

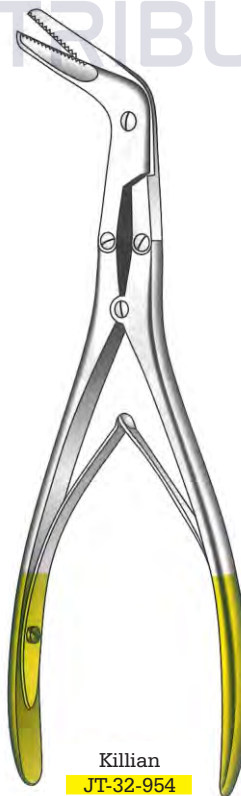

Killian
JT-32-954
21 cm / 8½"

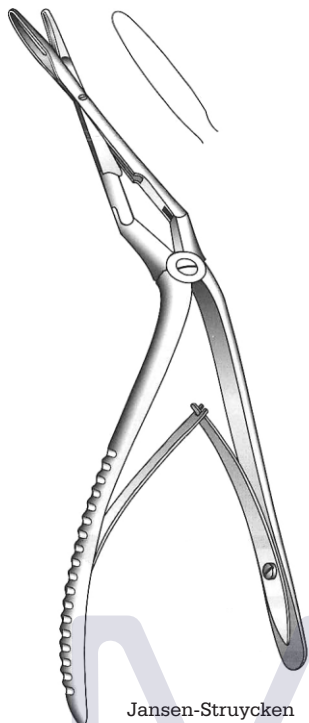

Jansen-Struycken
J-32-930
19 cm / 7½"

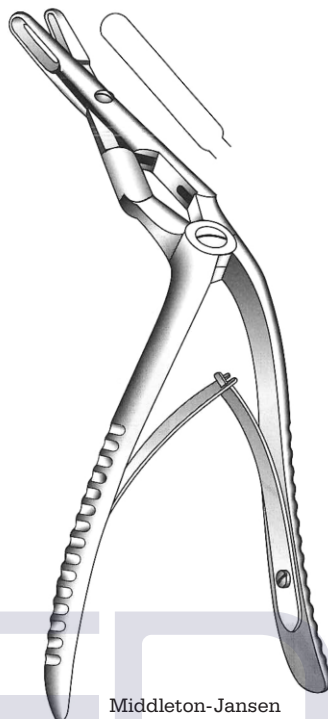

Middleton-Jansen
J-32-940
19 cm / 7½"

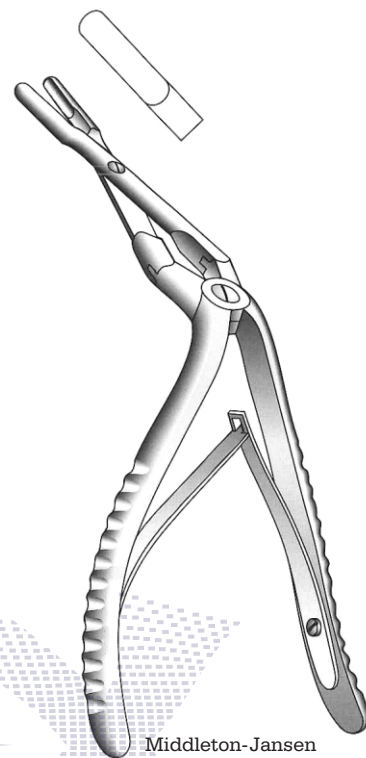

Middleton-Jansen
J-32-950
19 cm / 7½"



Protective Guard
According to the requirements
of operation, the cap may be
placed either on the right or the left jaw.

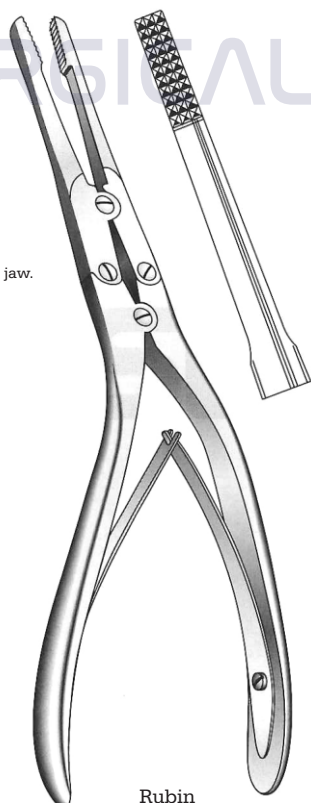

Rubin
J-32-951
21 cm / 8½"



Protective Guard
According to the requirements
of operation, the cap may be
placed either on the right or the left jaw.

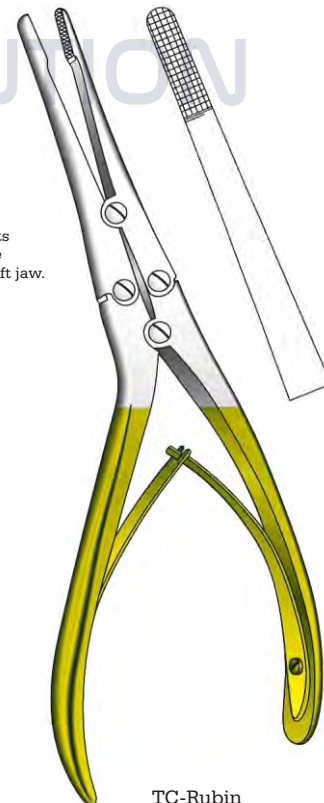

TC-Rubin
JT-32-354
21 cm / 8½"
Surgi Grip



SURGICAL DISTRIBUTION

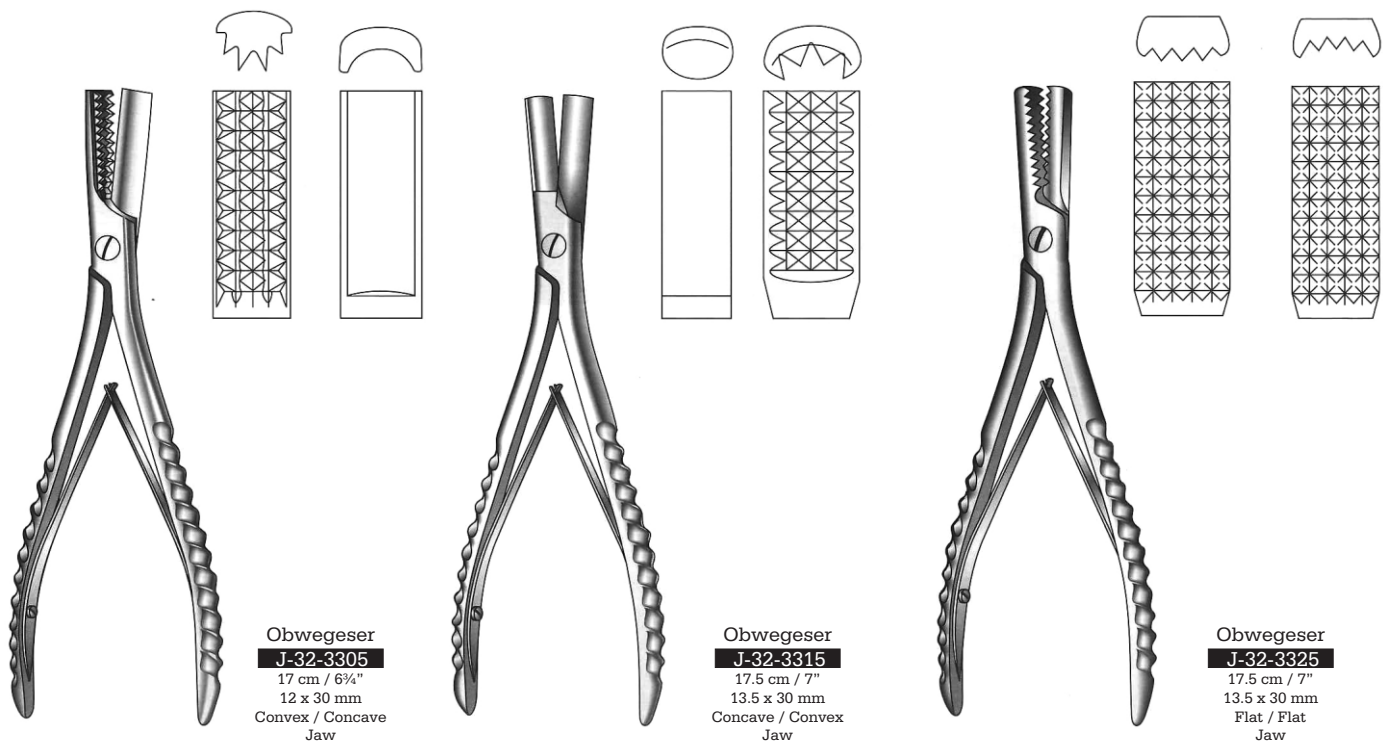

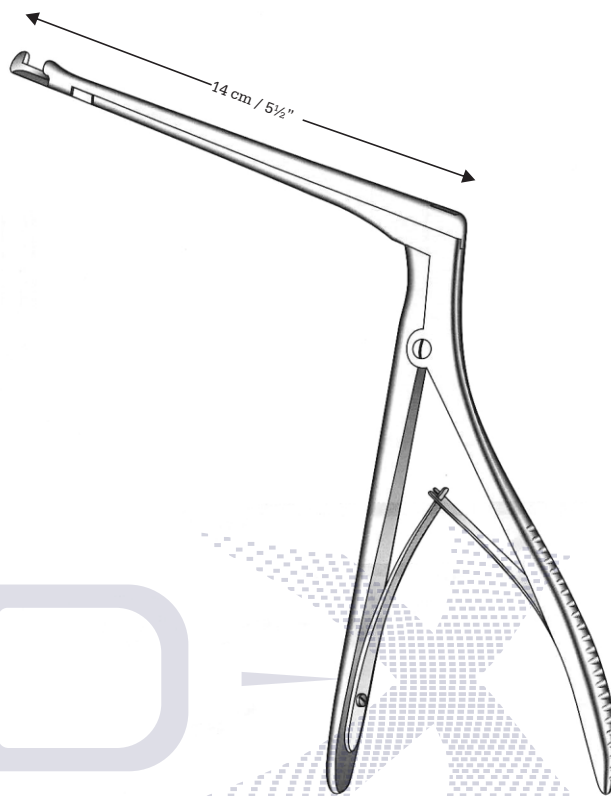
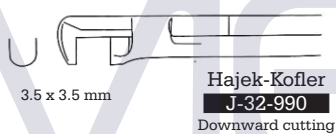
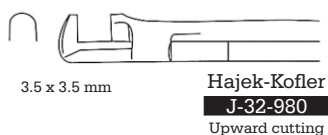
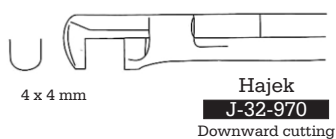
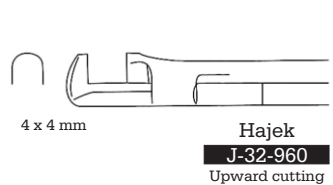

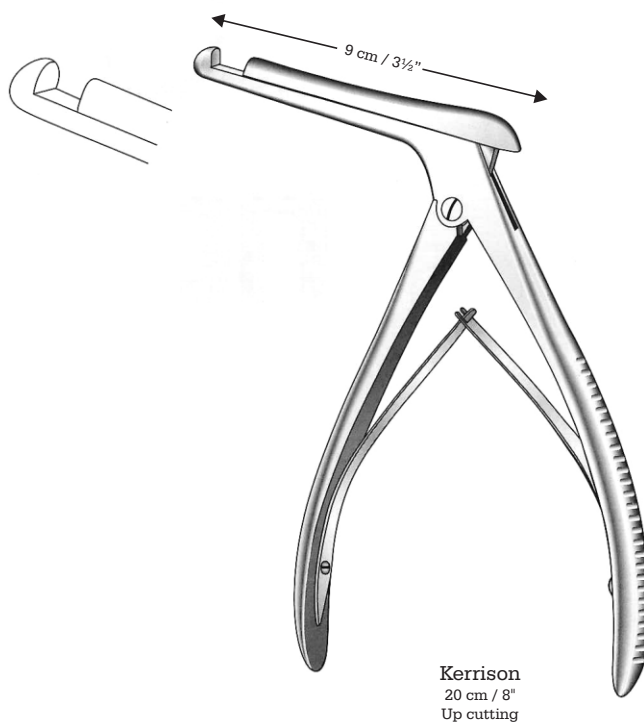
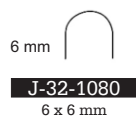
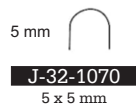
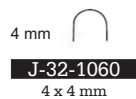

MED
SURGICAL DISTRIBUTION

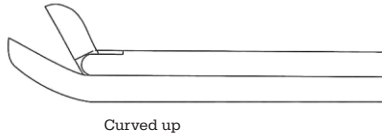



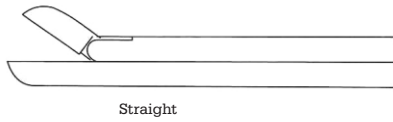



-  **J-32-1081** 2 x 10 mm
-  **J-32-1082** 3 x 10 mm
-  **J-32-1083** 4 x 10 mm
-  **J-32-1084** 5 x 10 mm
-  **J-32-3630** 6 x 10 mm



-  **J-32-1085** 2 x 10 mm
-  **J-32-1086** 3 x 10 mm
-  **J-32-1087** 4 x 10 mm
-  **J-32-3635** 5 x 10 mm
-  **J-32-3640** 6 x 10 mm



-  **J-32-1088** 2 x 10 mm
-  **J-32-1089** 3 x 10 mm
-  **J-32-1091** 4 x 10 mm
-  **J-32-3650** 5 x 10 mm
-  **J-32-3655** 6 x 10 mm

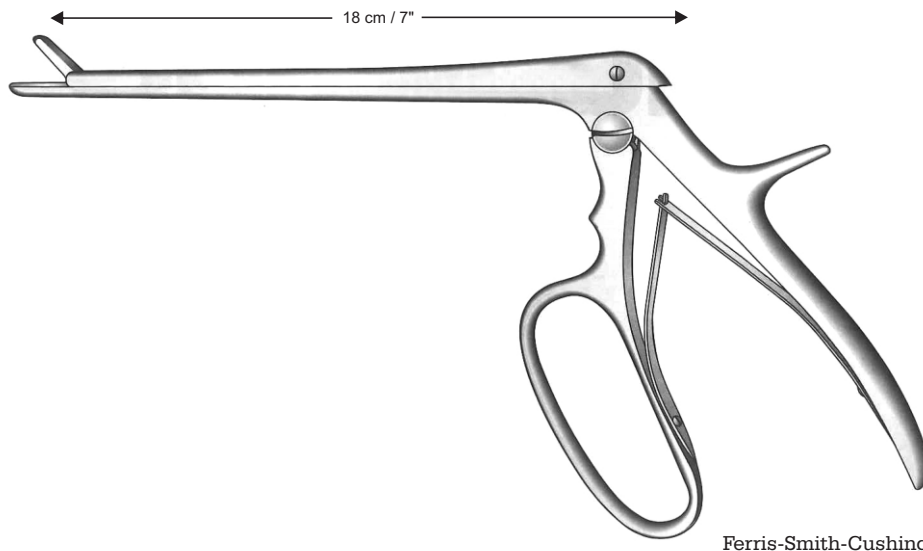

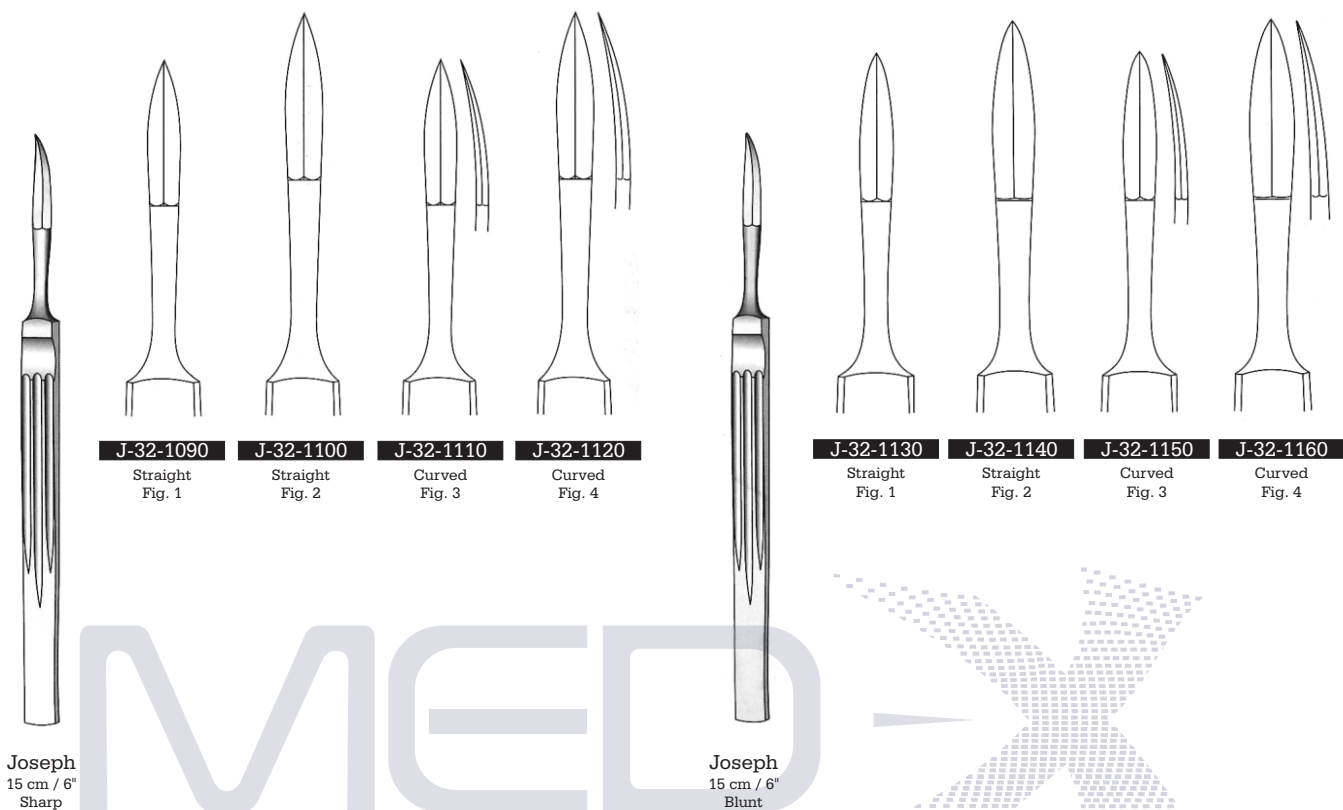

MEDIX
SURGICAL DISTRIBUTION

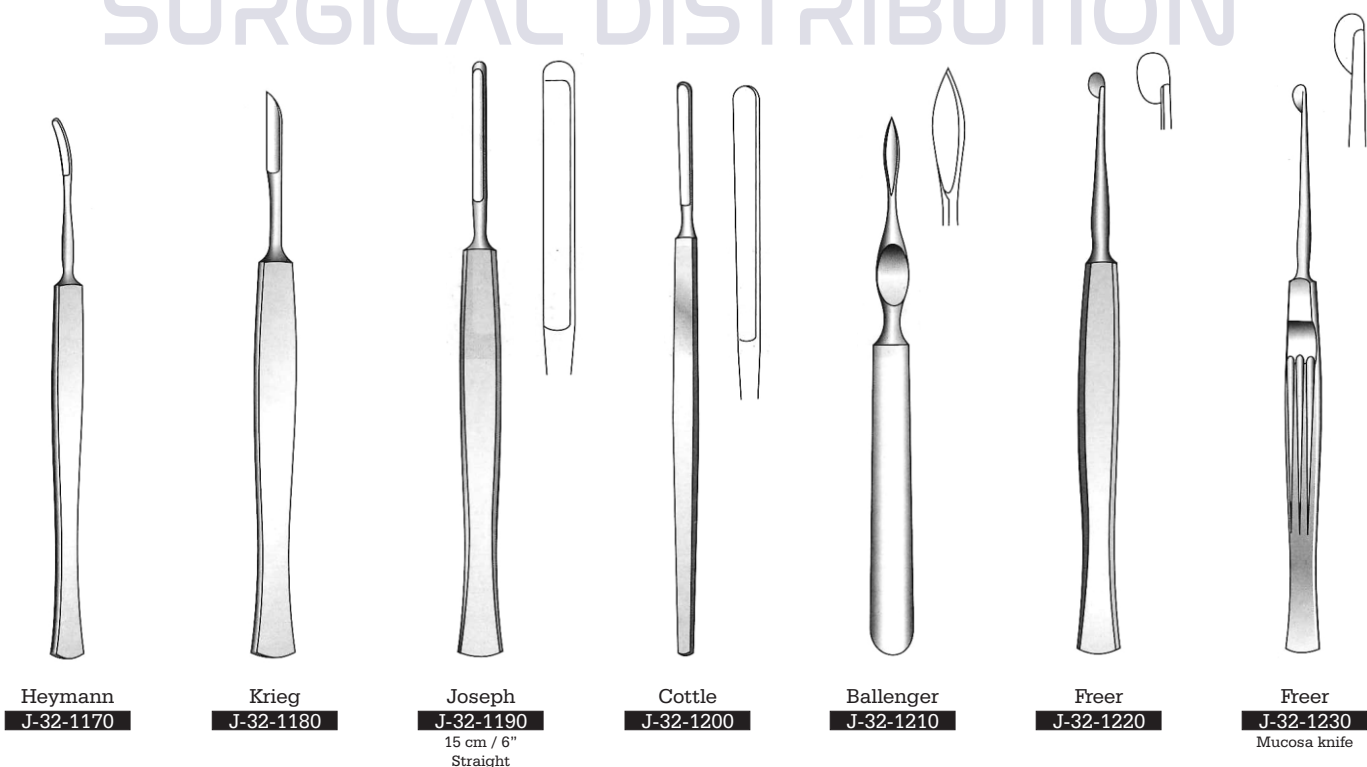



Knives
J-32-1223
 Double Ended, 5 mm



Knives
J-32-1224
 Double Ended, 6 mm

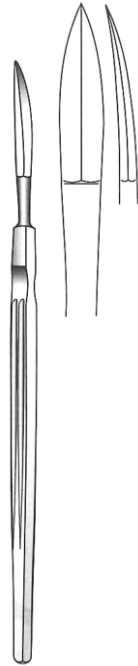

Fomon
J-32-1231
 16.5 cm / 6 1/2"

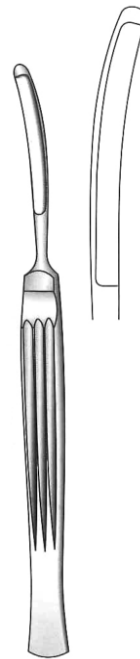

Converse
J-32-1232
 16 cm / 6 1/4"
 Curved blade 4 x 35 mm
 with button end bistouri



Cottle
J-32-1233
 14 cm / 5 1/2"

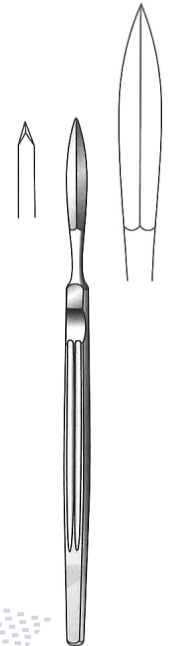

Cottle
J-32-5680
 14 cm / 5 1/2"

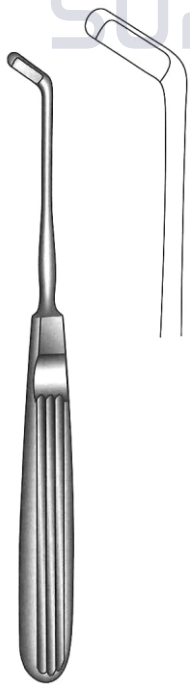

Joseph
J-32-5685
 16 cm / 6 1/4"
 Septum cartilage knife

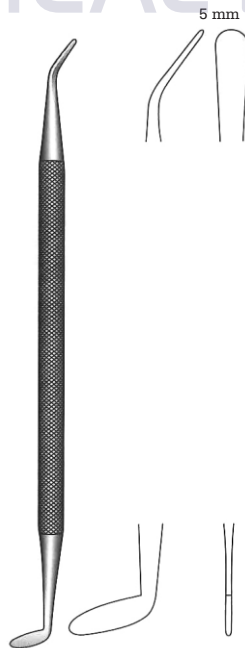

Nagata
J-32-5690
 16 cm / 6 1/4"

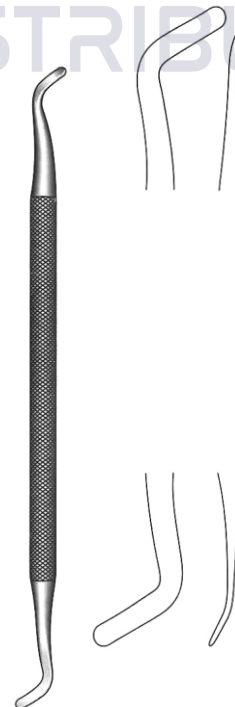

Nagata
J-32-5695
 17 cm / 6 3/4"

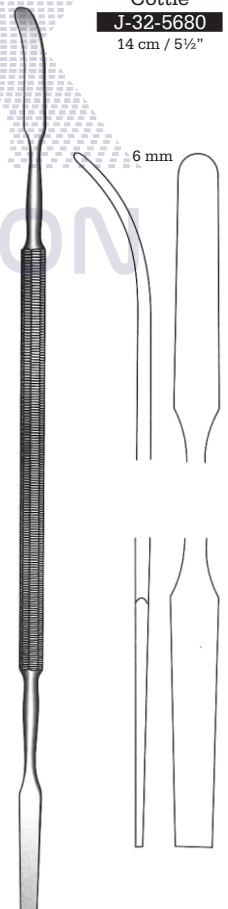

Cohen
J-32-5720
 24 cm / 9 1/2"
 Harvesting of coastal cartilages



Freer

J-32-1240



Freer

J-32-1250



Freer

J-32-1260

19 cm / 7½"



Freer

J-32-1270

19 cm / 7½"

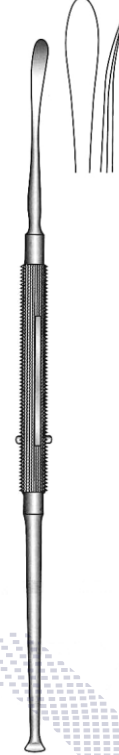

Freer

J-32-1280

19 cm / 7½"

Sharp

5 mm

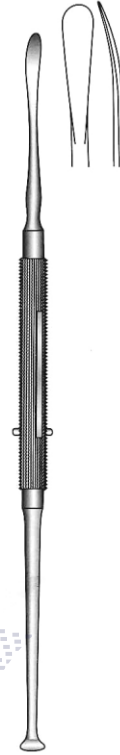

Freer

J-32-1290

19 cm / 7½"

Blunt

6 mm



Durham

J-32-1310



Howarth

J-32-1320



Hill

J-32-1330



Freer

J-32-3350

19.5 cm / 7¾"

J-32-3351

22 cm / 8¾"

Blunt / Sharp

Square handle



Freer



J-32-1300

16 cm / 6¼"

J-32-1305

19 cm / 7½"

Sharp / Blunt

5 / 5 mm



J-32-5700

J-32-5701

Sharp / Blunt

6.5 / 6.5 mm



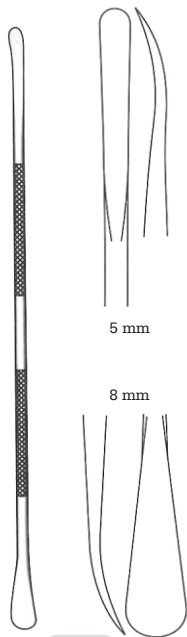

Terry
J-32-2100
 17 cm / 6 3/4"
 For elevation of alveolar flaps



Terry
J-32-2110
 11 cm / 4 1/4"
 Graft packer

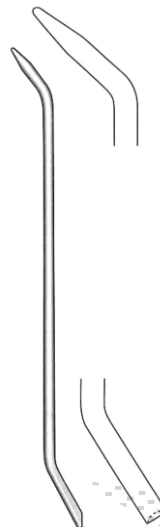

J-32-2120
 13 cm / 5"
 Graft packer

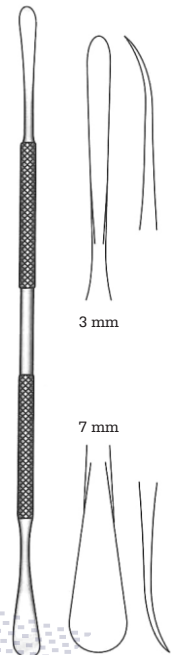

Terry
J-32-2130
 18 cm / 7"
 For subperiosteal tunnels

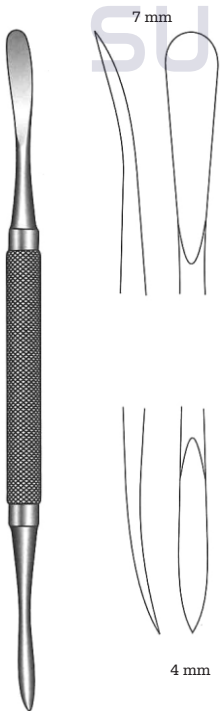

Dingman
J-32-5830
 18 cm / 7"



Obwegeser-Freer
 20.5 cm / 8"
 Blunt/Sharp point

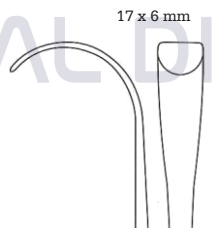

J-32-2230



6 mm

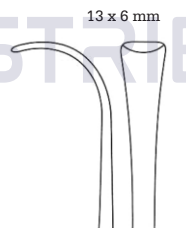

J-32-2240



6 mm



J-32-5835



5 mm



J-32-3360
 2 mm
 Sharp point



Ideal for precise subperichondral preparation at the septum and subperiosteal preparation of the osturbinale.

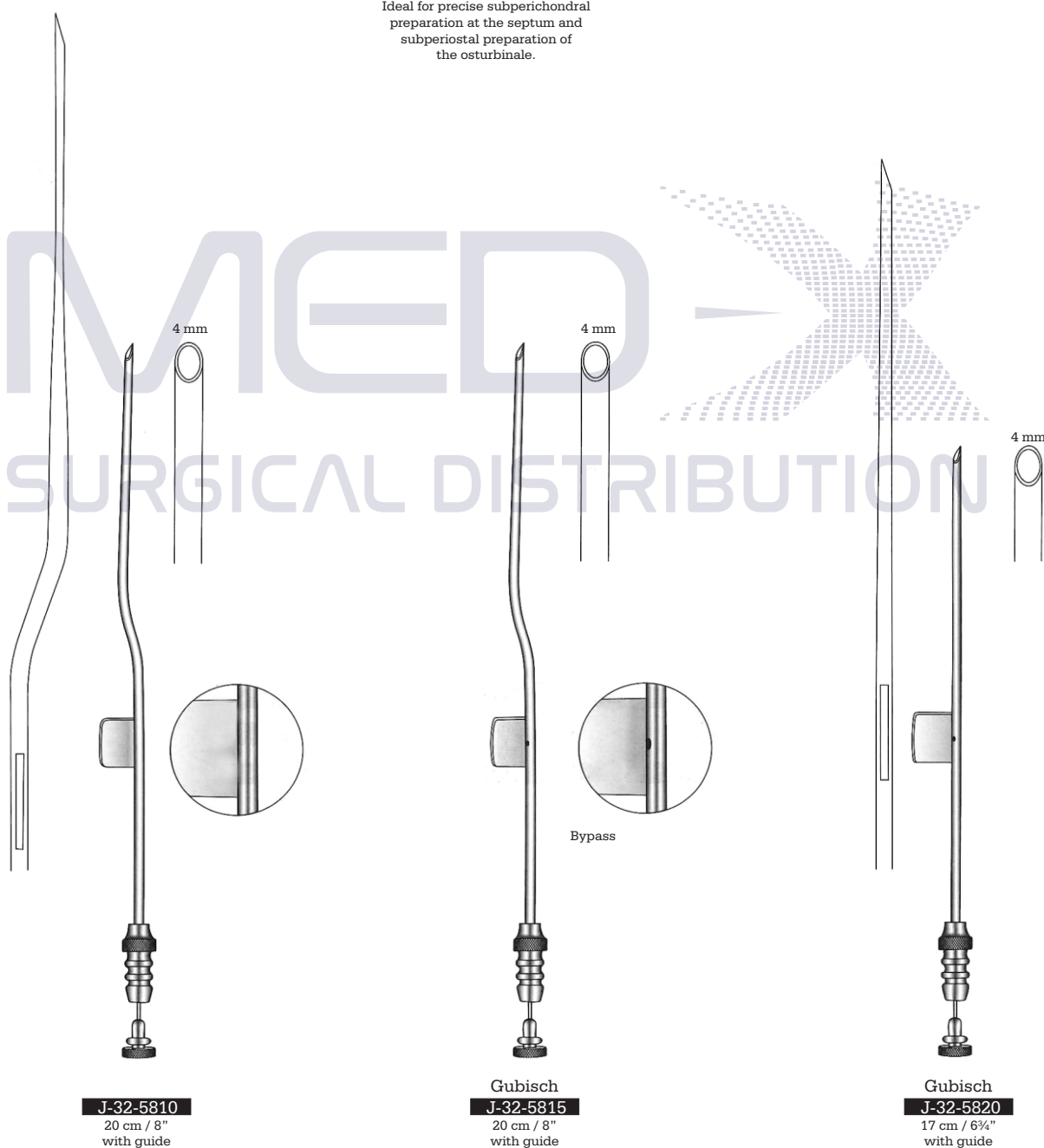

J-32-5810
20 cm / 8"
with guide

Gubisch J-32-5815
20 cm / 8"
with guide

Gubisch J-32-5820
17 cm / 6¾"
with guide

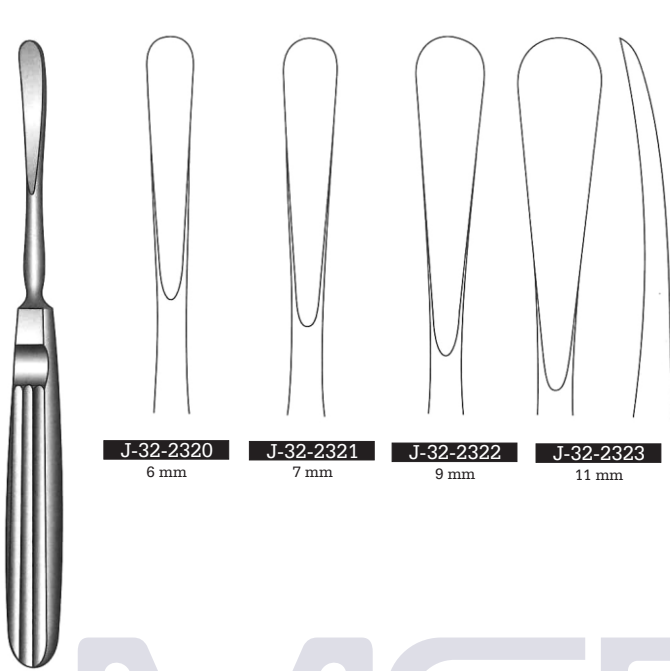

J-32-2320 6 mm
J-32-2321 7 mm
J-32-2322 9 mm
J-32-2323 11 mm

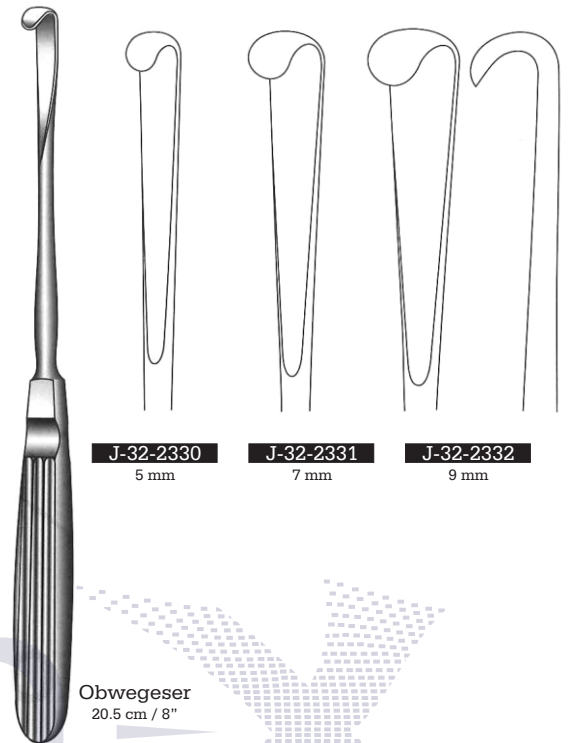

J-32-2330 5 mm
J-32-2331 7 mm
J-32-2332 9 mm

Obwegeser
 17.5 cm / 7"

Obwegeser
 20.5 cm / 8"

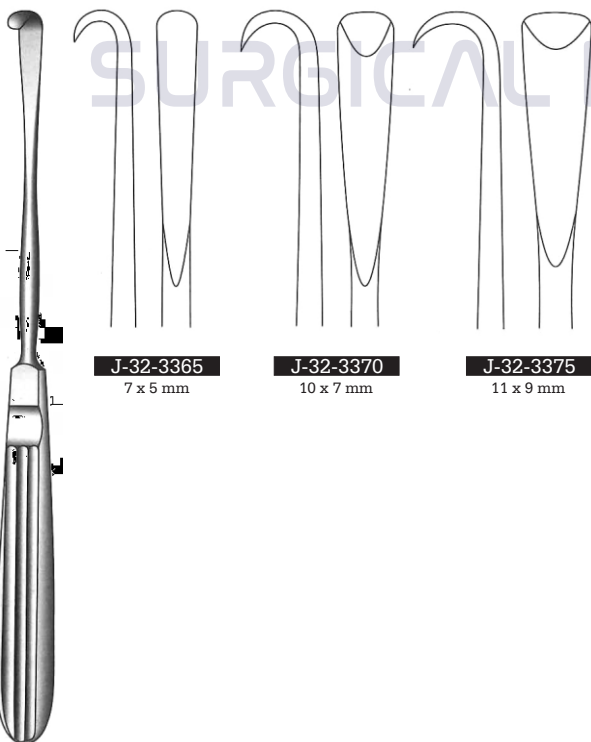

J-32-3365 7 x 5 mm
J-32-3370 10 x 7 mm
J-32-3375 11 x 9 mm

Obwegeser
 20.5 cm / 8"

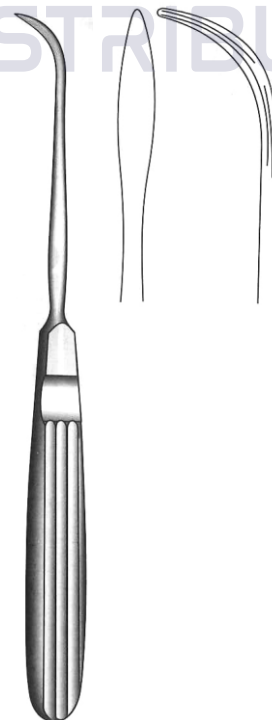

Steinhauser
J-32-2340
 18.5 cm / 7 1/4"

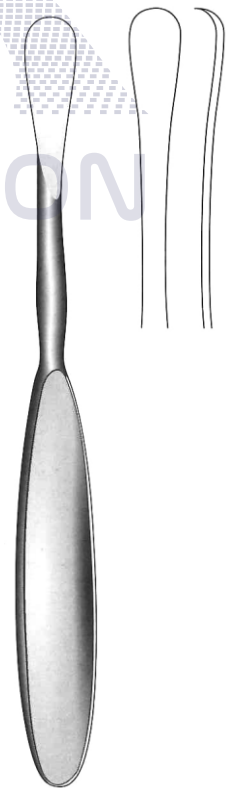

Lane Periosteal Elevator
J-32-3390 Narrow tip sharp
J-32-3391 Wide tip sharp
J-32-3392 Narrow tip blunt
J-32-3393 Wide tip blunt
 19 cm / 7 1/2"

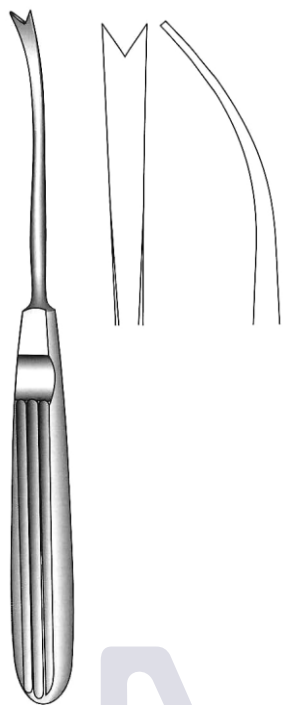

Steinhäuser
J-32-2280
18 cm / 7"
Reposition instrument

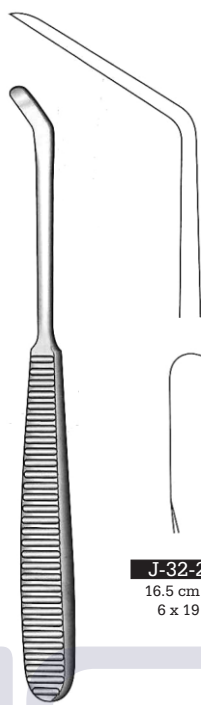

Steinhäuser

J-32-2271
16.5 cm / 6½"
6 x 19 mm

J-32-2270
16 cm / 6¼"
6 x 12 mm

J-32-2272
17 cm / 6¾"
6 x 26 mm



Obwegeser
17.5 cm / 7"

J-32-2290
Straight
9 mm

J-32-2291
Curved
9 mm

MED

SURGICAL DISTRIBUTION

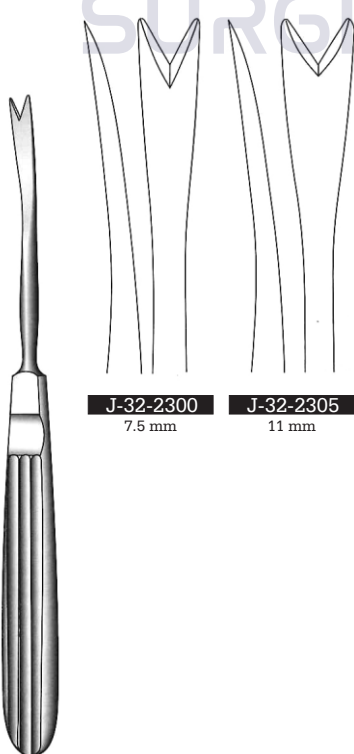

Obwegeser
17.5 cm / 7"

J-32-2300
7.5 mm

J-32-2305
11 mm

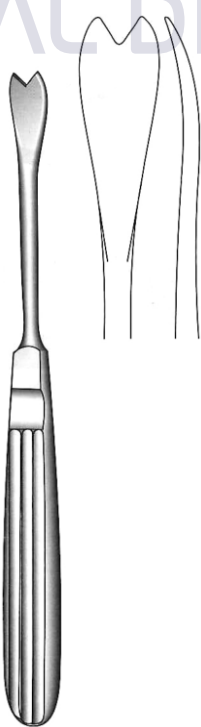

Obwegeser
J-32-2310
17.5 cm / 7"
11 mm



Williger
16 cm / 6¼"

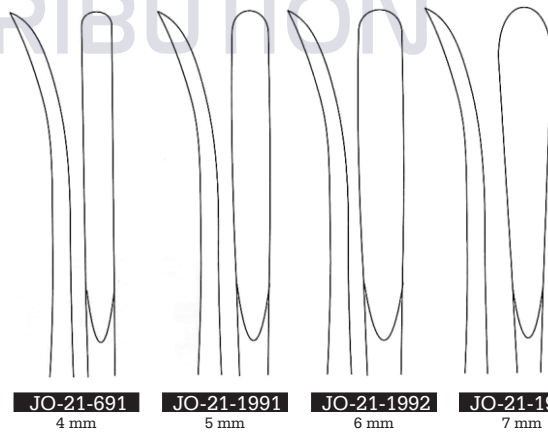

Preparation of the access for the lateral osteotomy

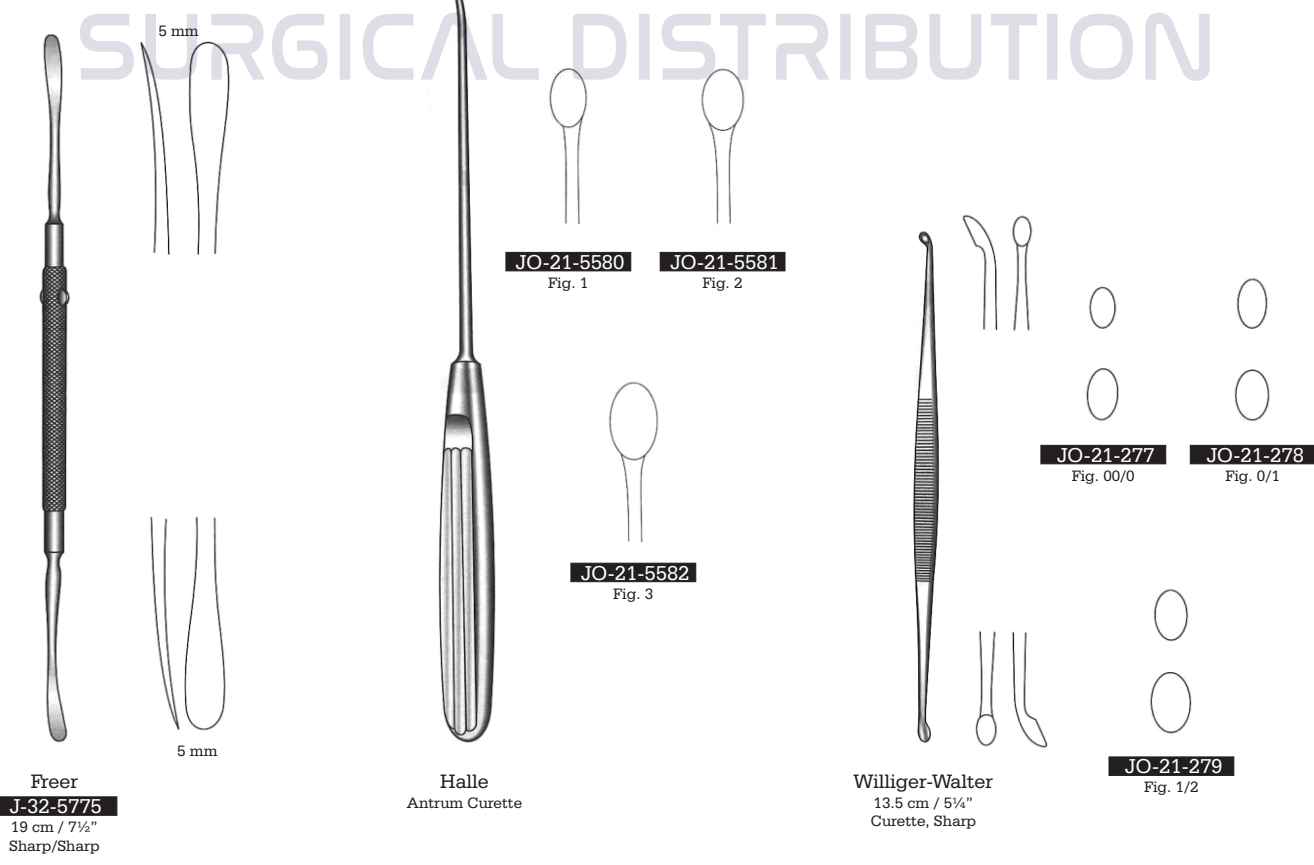
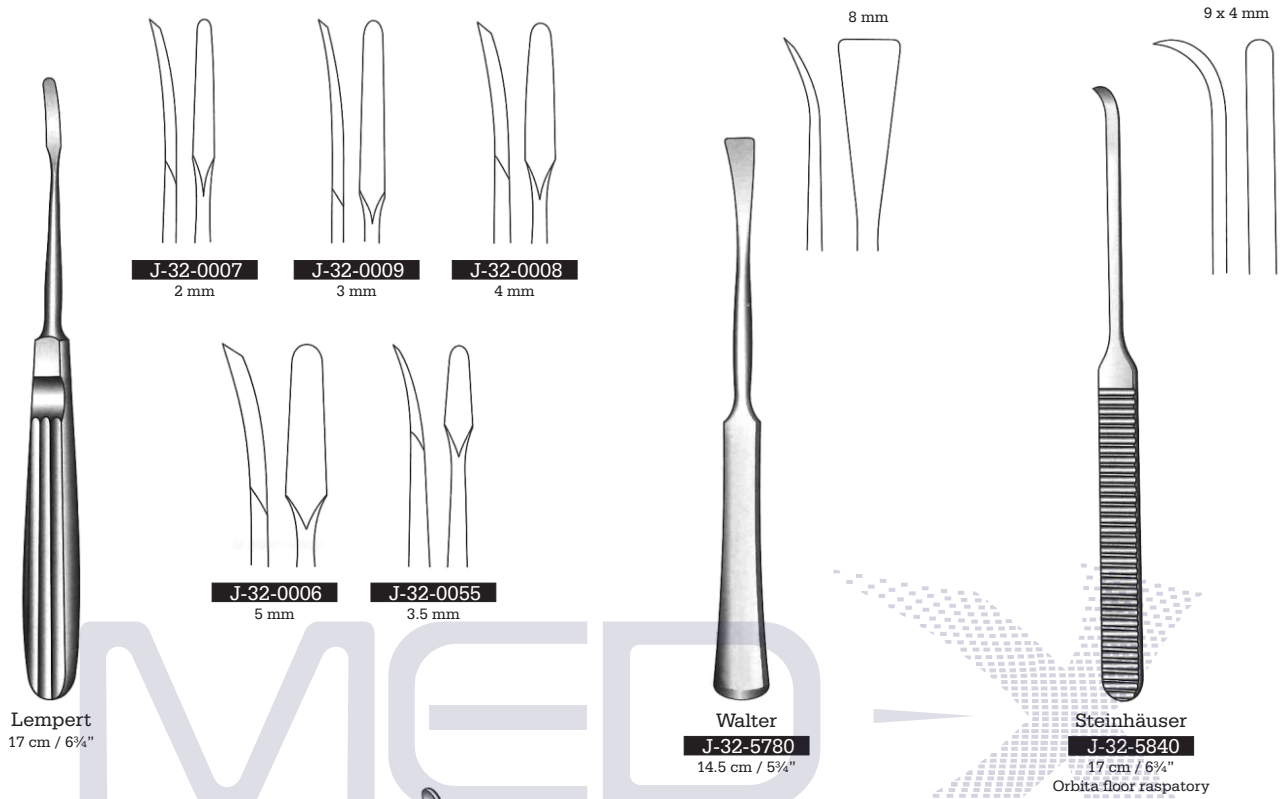

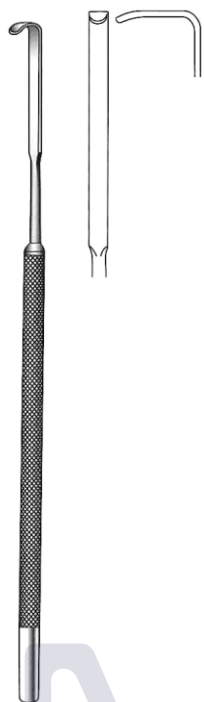

Salyer
J-32-2140
18.5 cm / 7¼"
Cleft palate hooklets
Short blade

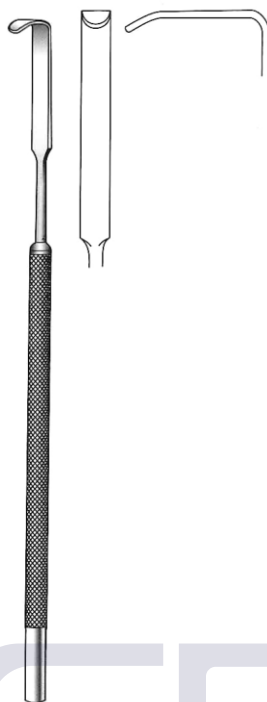

Salyer
J-32-2150
18.5 cm / 7¼"
Cleft palate hooklet
Long blade

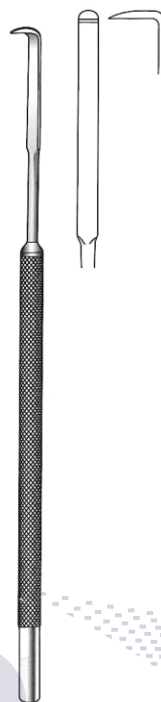

Salyer
J-32-2160
18 cm / 7"
Cleft palate dissector
Nasal

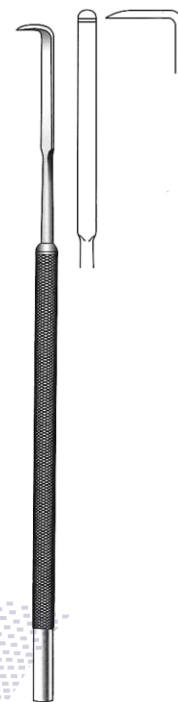

Salyer
J-32-2170
18 cm / 7"
Cleft palate dissector
Nasal

SURGICAL DISTRIBUTION



Salyer
J-32-2180
18 cm / 7"
Cleft palate instruments



Salyer
J-32-2190
18 cm / 7"
Cleft palate elevator



Salyer
J-32-2200
18 cm / 7"
Cleft palate elevator

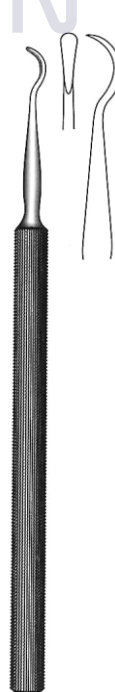

Jaboma
J-32-2210
17 cm / 6¾"
Cleft palate periosteal elevator



Obwegeser
 18 cm / 7"
 Angled cutting

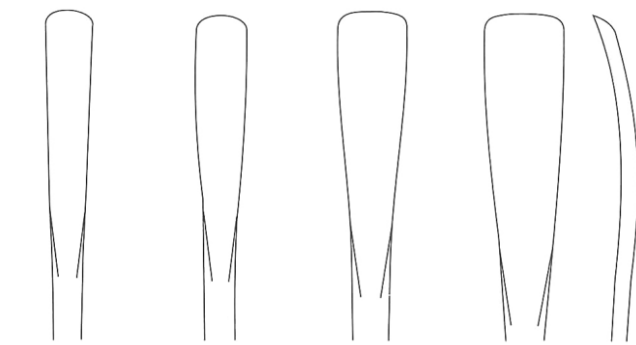

J-32-2260 6 mm
J-32-2261 7 mm
J-32-2262 9 mm
J-32-2263 11 mm



Converse
J-32-5800
 18 cm / 7"

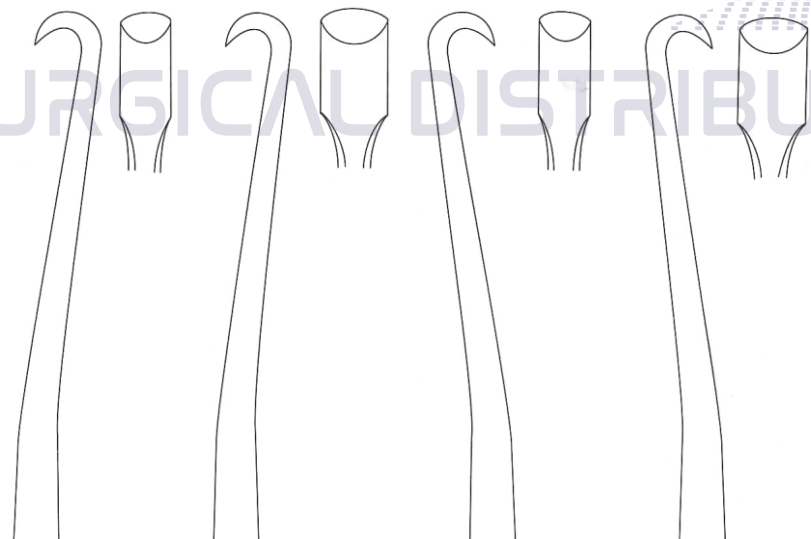
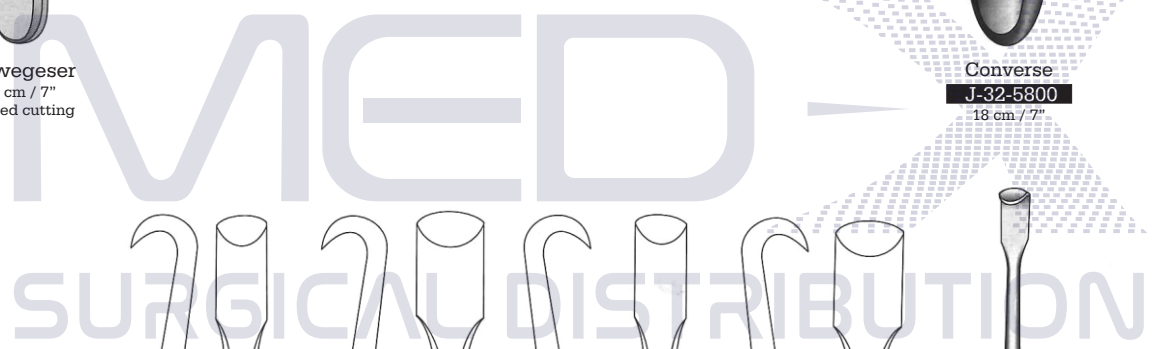

J-32-3510 6.5 mm Right
J-32-3511 9 mm Right
J-32-3512 6.5 mm Left
J-32-3513 9 mm Left

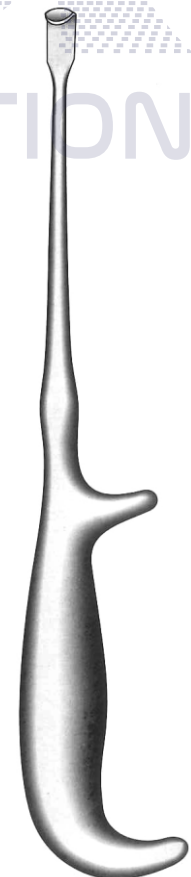

Hargis
 23 cm / 9"



Marchac
15.5 cm / 6"



J-32-2350
7.5 mm

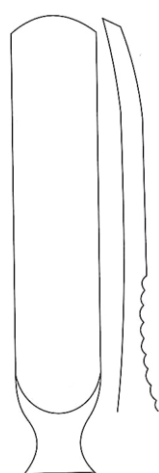

J-32-2351
12 mm

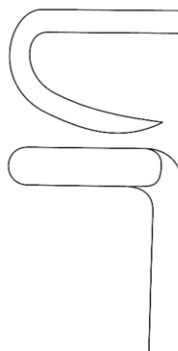

J-32-5790
Left

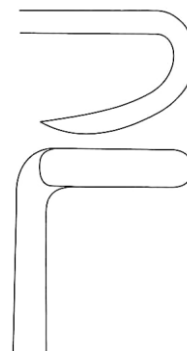

J-32-5792
Right



Obwegeser
30 cm / 11 3/4"
Rib raspatorien



Marchac
17 cm / 6 3/4"



J-32-2360
2 mm



J-32-2361
3.5 mm



J-32-2362
5 mm



J-32-2451
5 mm



J-32-2450
4 mm

Dissection of the
meatus inferior



McKenty
15 cm / 6"

MEDIX
SURGICAL DISTRIBUTION

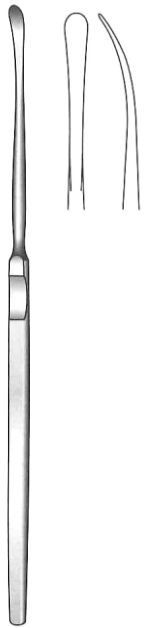

Halle
J-32-2460
 16 cm / 6¼"
 3.5 mm

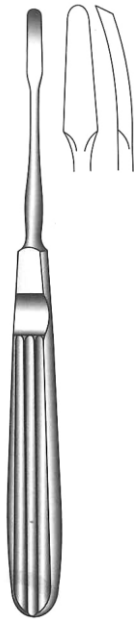

Joseph
J-32-2470
 16 cm / 6¼"
 4 mm
 Light curve wide blade

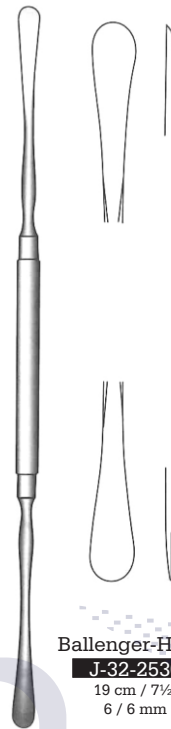

Ballenger-Hajek
J-32-2530
 19 cm / 7½"
 6 / 6 mm



Cottle
J-32-5755
 16 cm / 6¼"
 Septum-Elevatorien

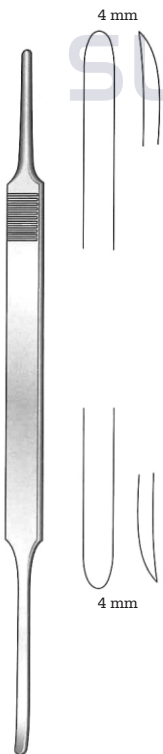

McKenty
J-32-2520
 20.5 cm / 8"
 4 / 4 mm

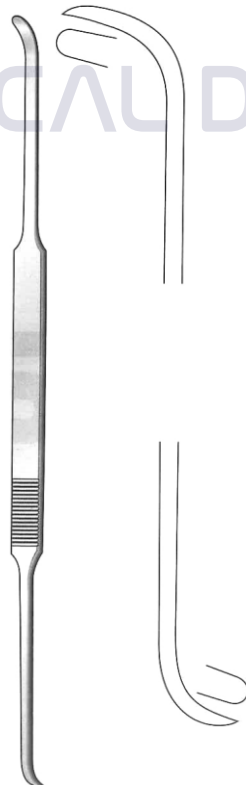

Cottle
J-32-2540
 23.5 cm / 9¼"
 5 / 5 mm

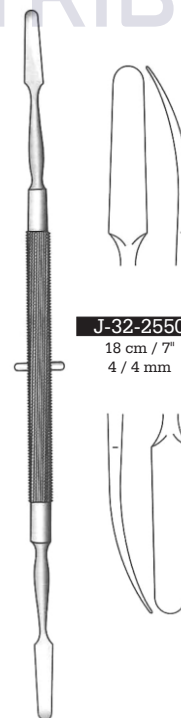

Killian

J-32-2550
 18 cm / 7"
 4 / 4 mm

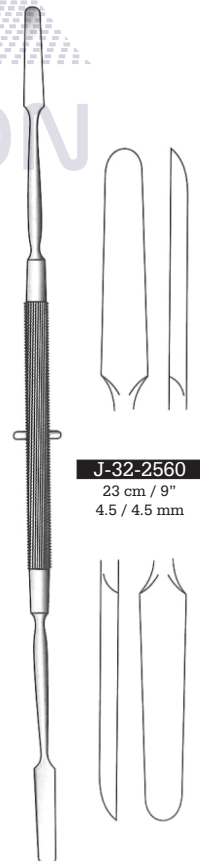

Killian

J-32-2560
 23 cm / 9"
 4.5 / 4.5 mm

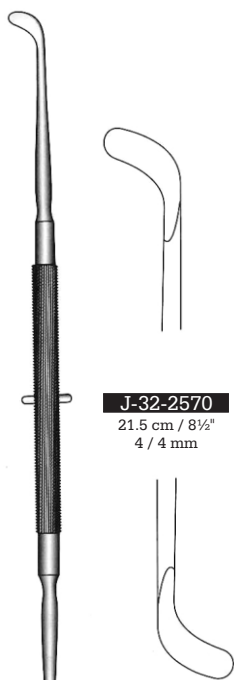

J-32-2570
21.5 cm / 8½"
4 / 4 mm

Pennington

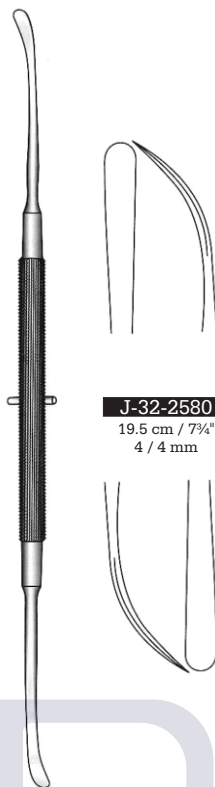

J-32-2580
19.5 cm / 7¾"
4 / 4 mm

Roger

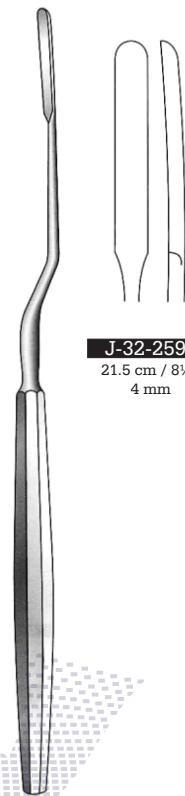

J-32-2590
21.5 cm / 8½"
4 mm

Joseph-Masing

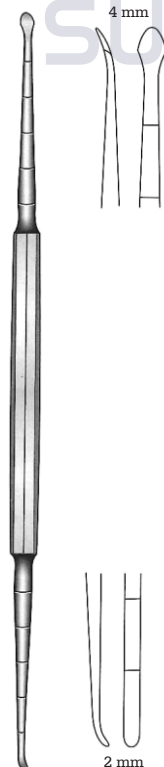

4 mm

2 mm

Cottle
J-32-2600
20 cm / 8"

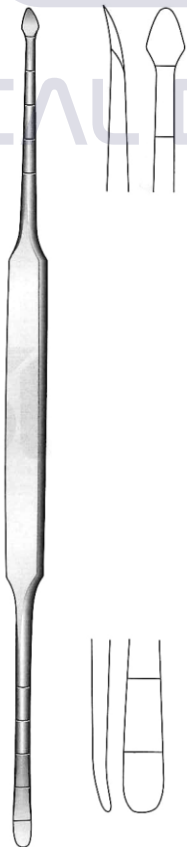

5 mm

Masing
J-32-2605
22 cm / 8¾"

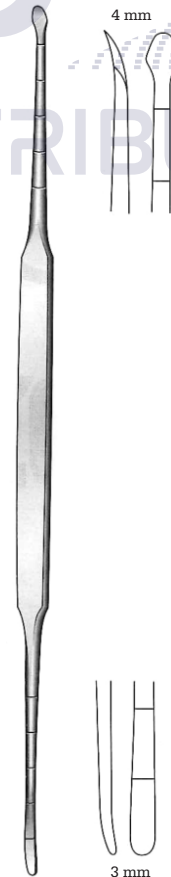

4 mm

3 mm

Cottle
J-32-2620
23 cm / 9"

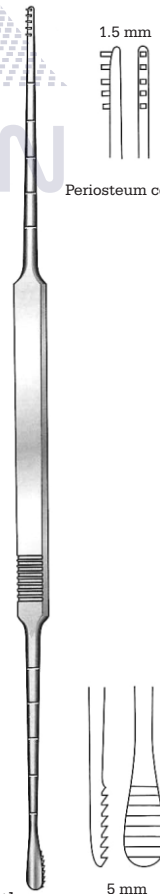

1.5 mm

Periosteum comb

Cottle
J-32-5825
23 cm / 6"
Periosteum file

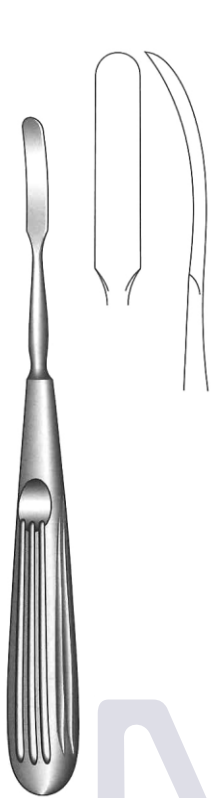

Joseph
J-32-2630
 18 cm / 7"
 6.5 mm



Ballenger
 21 cm / 8 1/4"
 Straight



J-32-1340
J-32-1350
 3 mm



J-32-1360
J-32-1370
 4 mm



J-32-1380
J-32-1390
 5 mm

Straight
 Angled

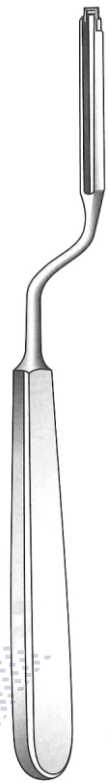

Ballenger
 20 cm / 8"
 Angled



Ballenger
J-32-1400
 15 cm / 6"



Freer
J-32-2640
 15 cm / 6"
 Septum gouge, 6 mm

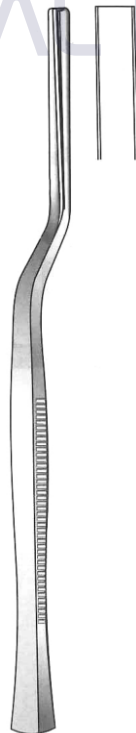

Killian
J-32-1410
 16 cm / 6 1/4"
 5 mm



Killian-Claus
J-32-1420
 16 cm / 6 1/4"
 5 mm

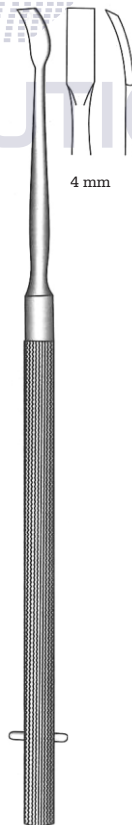

Freer
J-32-1430
 18 cm / 7"

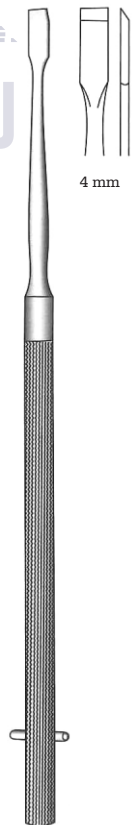

Freer
J-32-1440
 18 cm / 7"

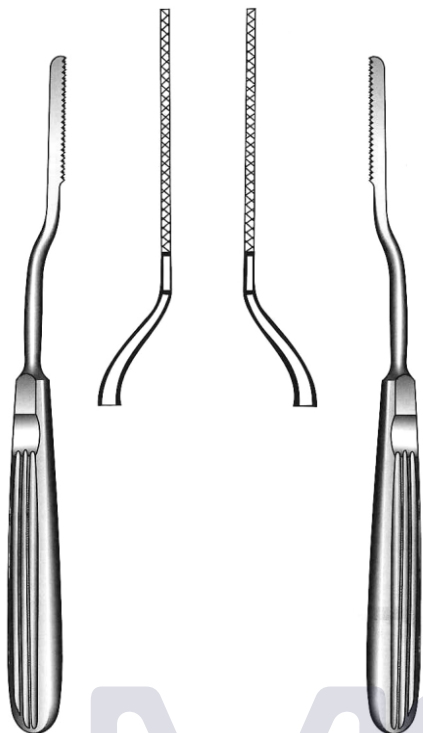

Joseph
J-32-1450
Curved to right

Joseph
J-32-1460
Curved to left

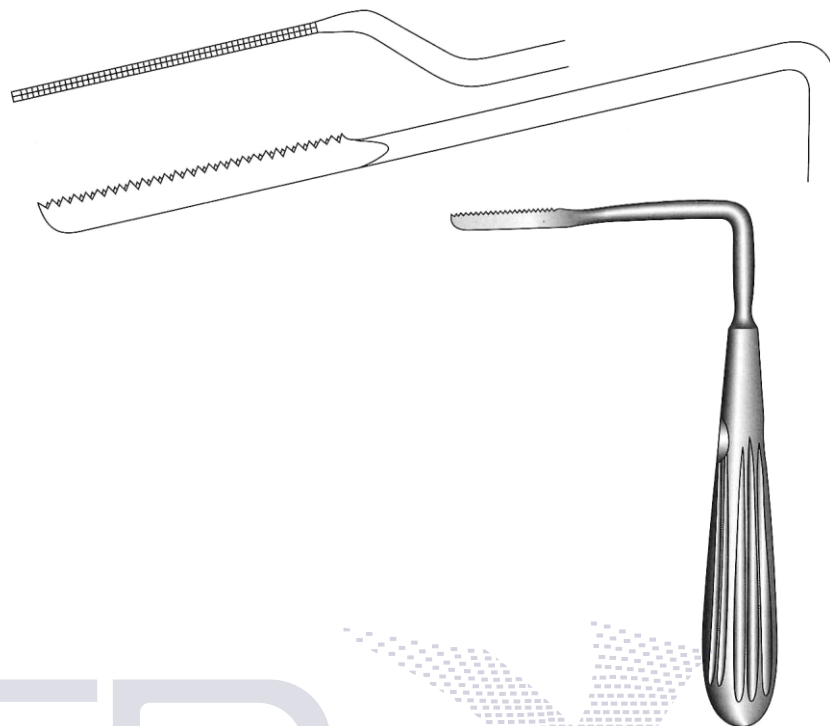

Joseph
J-32-1470
17 cm / 6 3/4"
Angled to left
Nasal knife

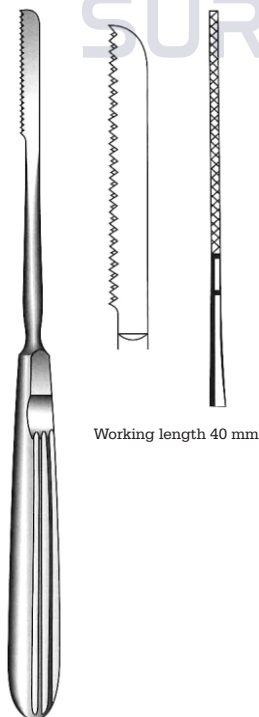

Working length 40 mm

Joseph
J-32-1455
19 cm / 7 1/2"
Straight

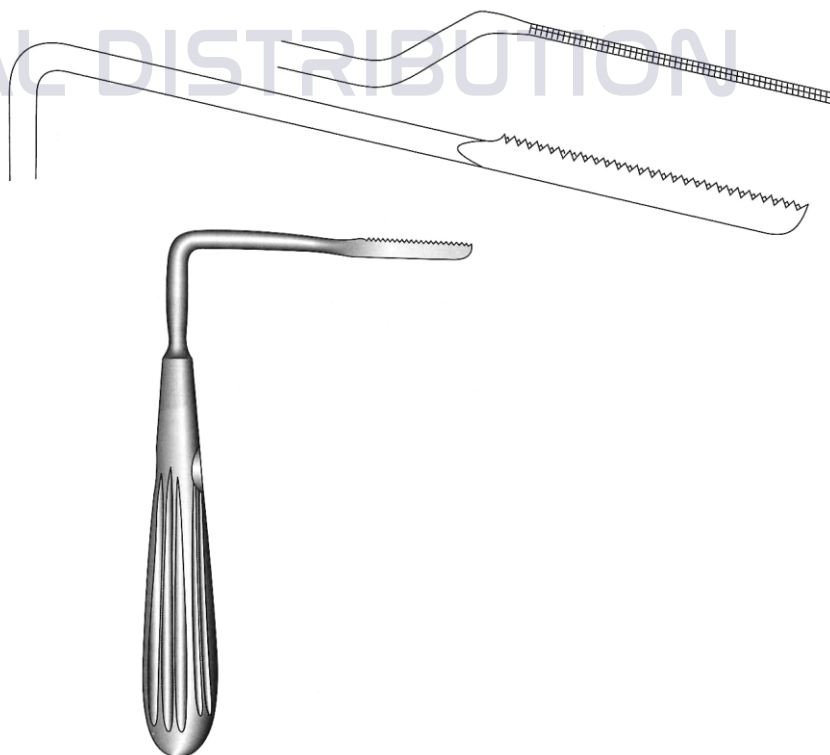

Joseph
J-32-1480
17 cm / 6 3/4"
Angled to right
Nasal knife



J-32-2650
 18 cm / 7"
 3 x 18 mm



J-32-2660
 18 cm / 7"
 3.5 x 23 mm



Tessier
 20.5 cm / 8"



J-32-2410
 12 mm



J-32-2420
 15 mm

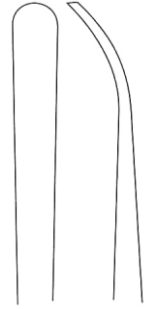

Tessier
J-32-3500
 18.5 cm / 7 1/4"
 6 mm, Angled 30°



Langenbeck
J-32-5710
 23 cm / 9"



10 mm

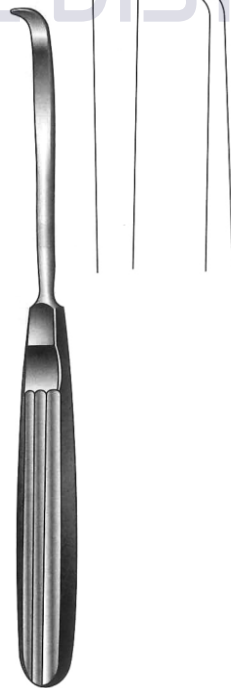

Tessier
J-32-3505
 18 cm / 7"
 6 mm
 Angled 60°



Langenbeck
 20 cm / 8"

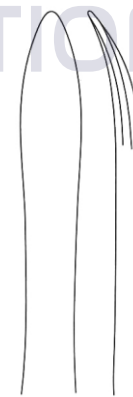

JO-21-670
 Tip 8 mm

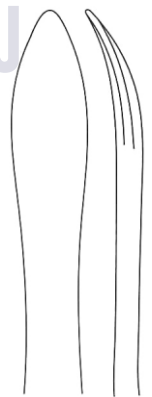

JO-21-2075
 Tip 10 mm

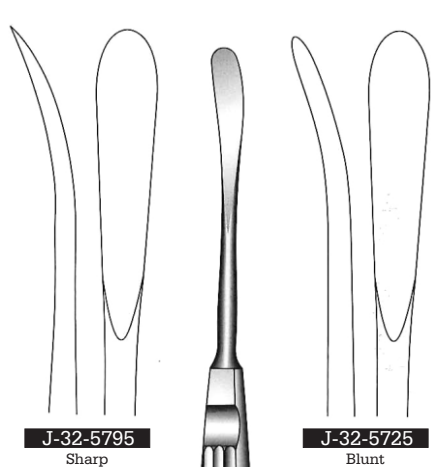

J-32-5795
Sharp

J-32-5725
Blunt

Cottle
18 cm / 7"
8 mm

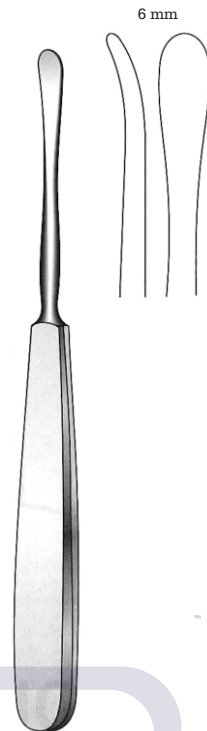

Yankauer
J-32-5730
18 cm / 7"
Septum Elevator

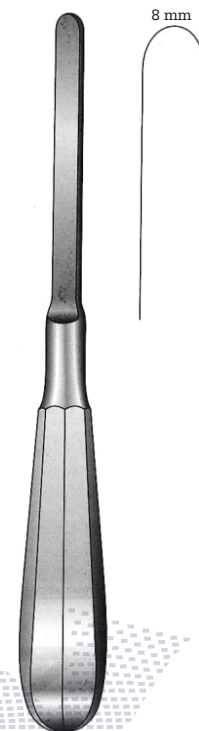

Boies
J-32-0018
19 cm / 7½"
Nasal fracture elevator

MEDICAL SURGICAL DISTRIBUTION

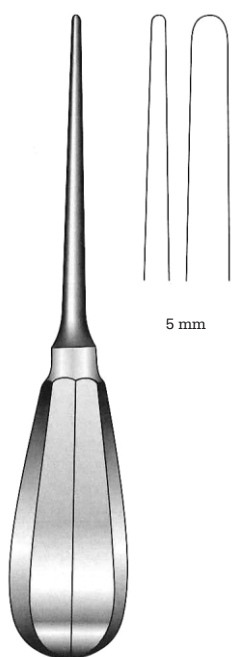

5 mm

Goldman
J-32-0014
17 cm / 6¾"
Septum fracture elevator

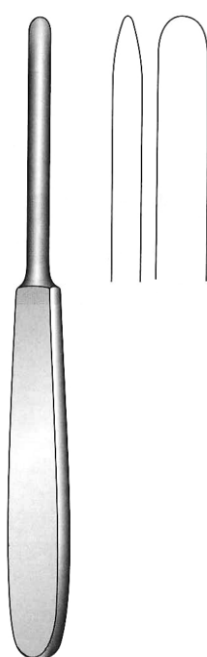

J-32-5740
17 cm / 6¾"
Respositioning of nasal bone fractures

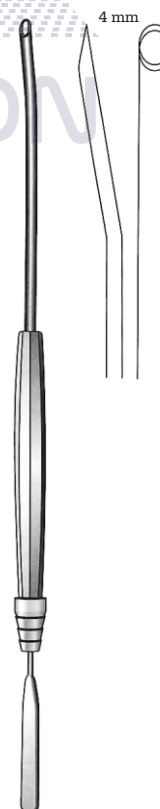

4 mm

J-32-5745
21 cm / 8¼"
Suction elevator
With Guide

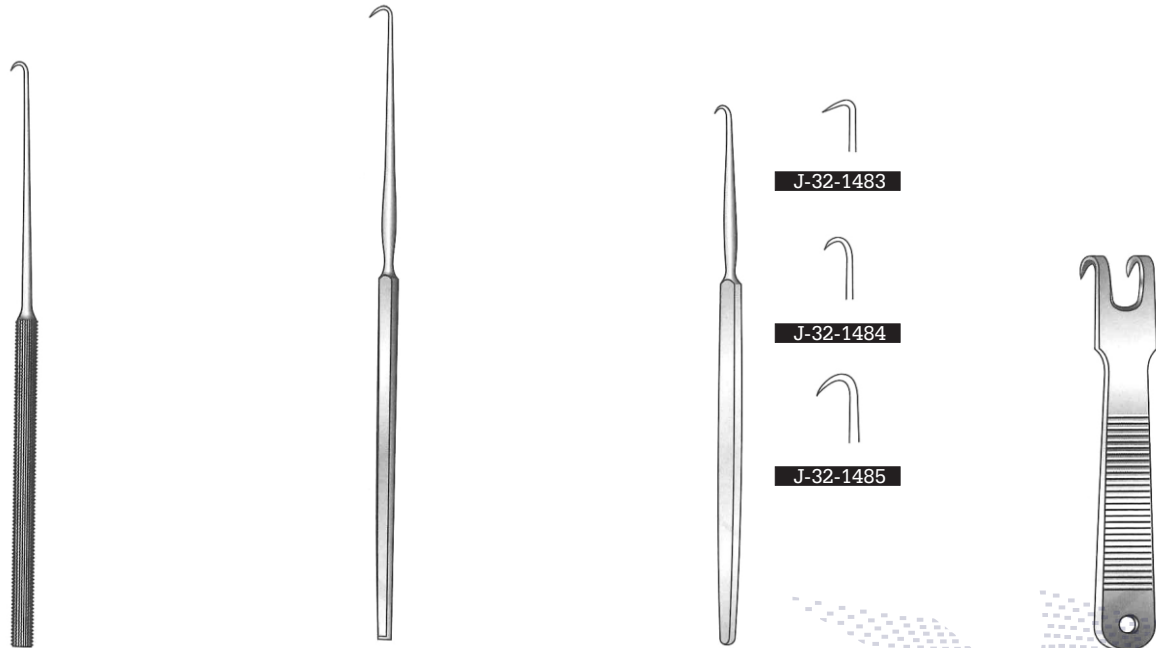

Joseph
J-32-1481
 15 cm / 6"
 Sharp

Cottle
J-32-1482
 16 cm / 6¼"
 Sharp

Cottle
 15 cm / 6"

Kilner
J-32-1486
 10 cm / 4"
 Sharp

MED 
 SURGICAL DISTRIBUTION

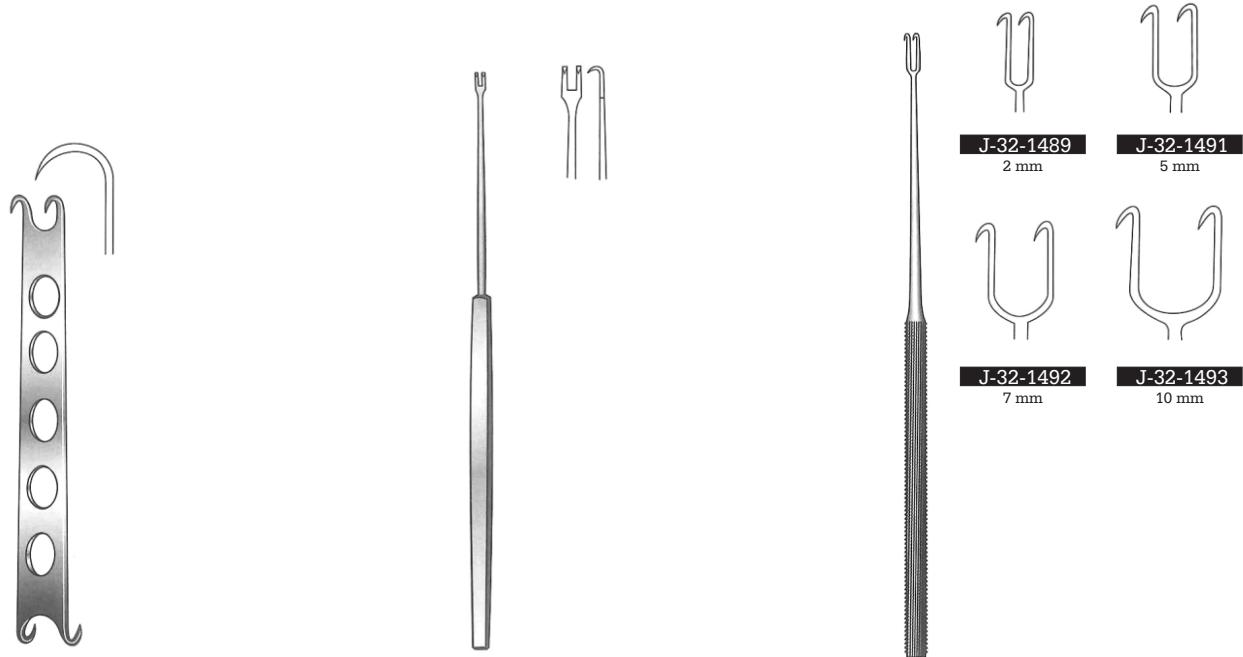

Converse
J-32-1487
 12 cm / 4¾"
 Double ended
 Sharp

Freer
J-32-1488
 15 cm / 6"
 Sharp

Joseph
 16 cm / 6¼"

J-32-1489
 2 mm

J-32-1491
 5 mm

J-32-1492
 7 mm

J-32-1493
 10 mm



Weighted Nasal Hook
J-30-320
Approx. weight, 2oz
Nasal hook

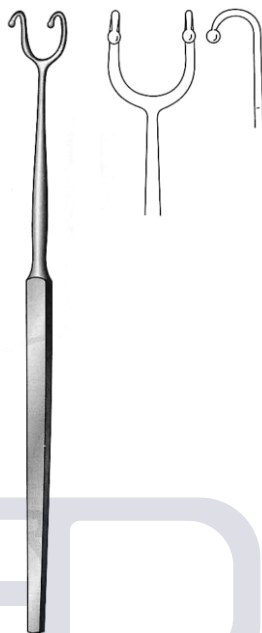

Fomon
J-32-1494
16 cm / 6¼"

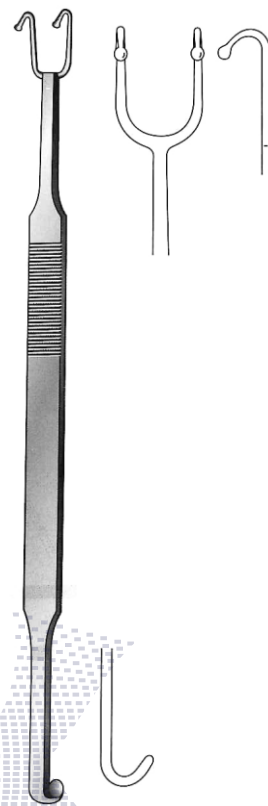

Cottle-Neivert
J-32-1495
20 cm / 8"

SURGICAL DISTRIBUTION

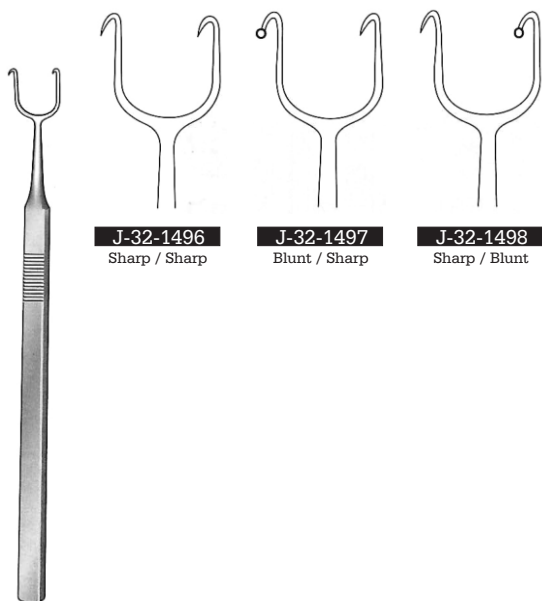

Cottle
15 cm / 6"

J-32-1496
Sharp / Sharp

J-32-1497
Blunt / Sharp

J-32-1498
Sharp / Blunt



18.5 cm / 7¼"

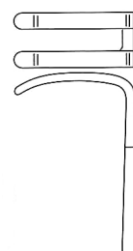

J-32-2670
14 x 17 mm
Koberg. mod
J-32-2671
20 x 7 mm



J-32-2680
17 cm / 6 3/4"



Rowe
J-32-2685
15 cm / 6"

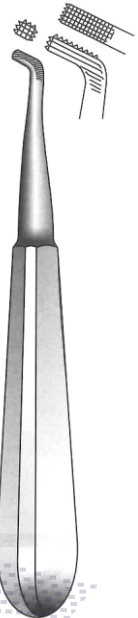

Mershon
J-32-2686
15 cm / 6"

MED 
SURGICAL DISTRIBUTION

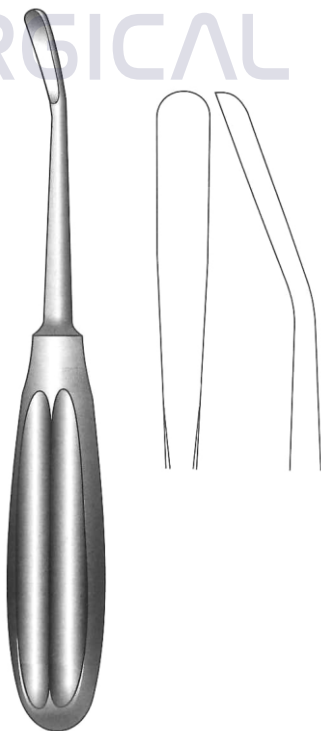

Gillies
J-32-2430
20 cm / 8"



Dingmann
J-32-2440
21 cm / 8 1/4"
Tip 5.0 mmØ

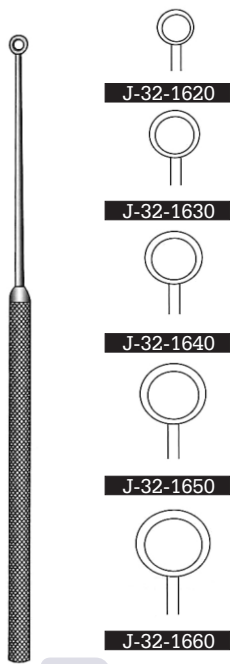

Myles
17 cm / 6 3/4"



Coakley
17 cm / 6 3/4"

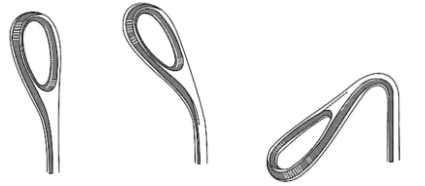

J-32-1680 J-32-1690 J-32-1700



J-32-1710 J-32-1720 J-32-1730

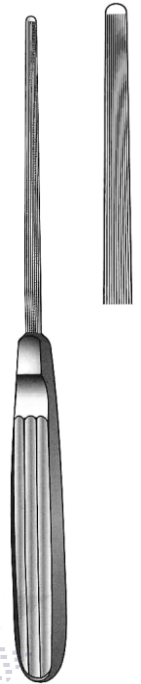

Tessier
J-32-1950
19.5 cm / 7 3/4"
Curette sharpener

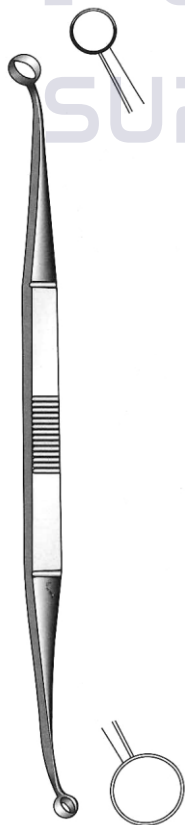

Faulkner
J-32-1670
21 cm / 8 1/4"

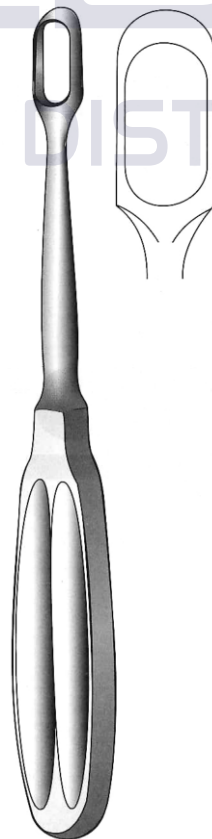

Tessier
J-32-1882
21.5 cm / 8 1/2"
12 mm

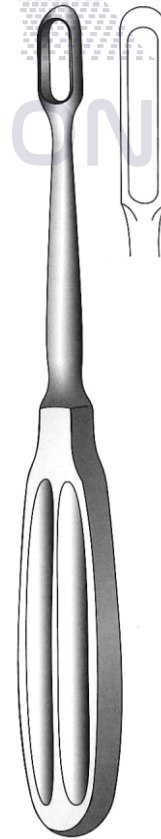

Tessier
J-32-1884
21.5 cm / 8 1/2"
6 mm

MEDICAL SURGICAL DISTRIBUTION



Beckmann
 22 cm / 8 3/4"

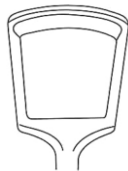

J-32-1840
 Fig. 1

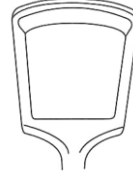

J-32-1850
 Fig. 2

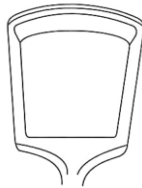

J-32-1860
 Fig. 3

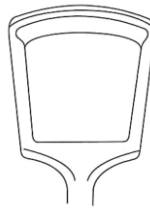

J-32-1870
 Fig. 4

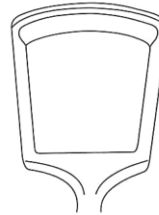

J-32-1880
 Fig. 5



J-32-1780
 16 mm
 Fig. 1



J-32-1790
 17 mm
 Fig. 2

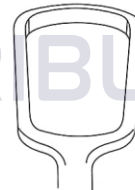

J-32-1800
 18 mm
 Fig. 3

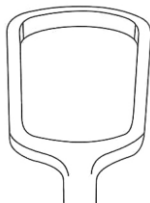

J-32-1810
 20 mm
 Fig. 4

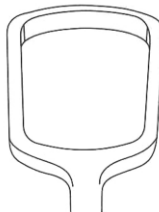

J-32-1820
 21 mm
 Fig. 5

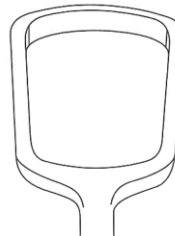

J-32-1830
 23 mm
 Fig. 6

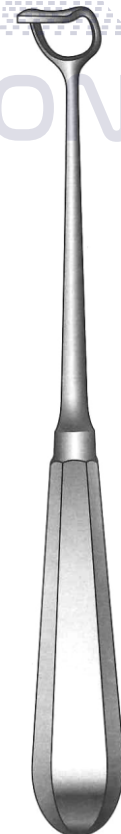

Beckmann
 22 cm / 8 3/4"
 Trapezoidal fenestrated

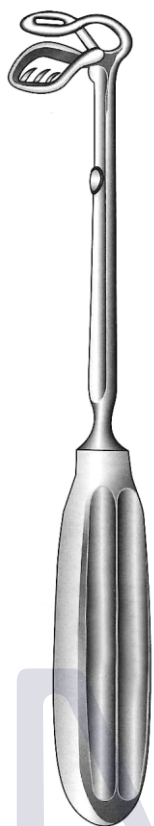

St. Clair-Thomson
21 cm / 8 1/4"



J-32-1890
11 mm



J-32-1900
13 mm



J-32-1910
15 mm



J-32-1920
17 mm

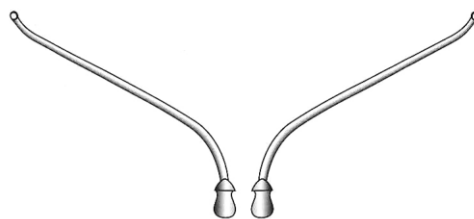

Hartmann

Fig. 1	mm ϕ	Fig. 2
J-32-1960	2	J-32-1990
J-32-1970	2.5	J-32-2000
J-32-1980	3	J-32-2001

MED X
SURGICAL DISTRIBUTION



Hartmann
J-32-2010 2 mm ϕ
J-32-2020 2.5 mm ϕ
J-32-2030 3 mm ϕ
12 cm / 4 1/4"

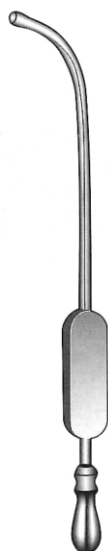

Eicken-Killian
J-32-2040
14 cm / 5 1/2"
3 mm ϕ
Irrigation cannula

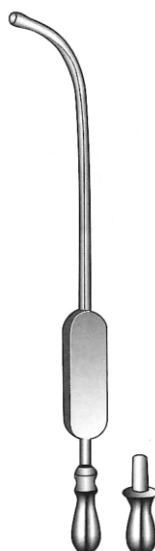

Eicken-Killian
J-32-2050
14 cm / 5 1/2"
3 mm ϕ



Killian
J-32-2060
17 cm / 6 3/4"
1.5 mm ϕ



Marchac
J-32-2065
19 cm / 7 1/2"

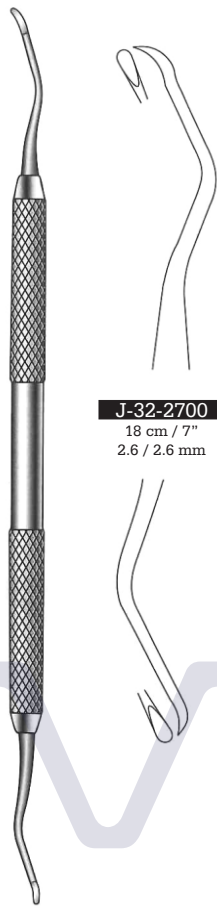

J-32-2700
 18 cm / 7"
 2.6 / 2.6 mm



J-32-2710
 17.5 cm / 7"
 2.6 / 2.6 mm



J-32-2711
 18 cm / 7"
 4.1 / 4.1 mm



J-32-2712
 18.5 cm / 7 1/4"
 4.1 / 4.1 mm



J-32-2714
 19 cm / 7 1/2"
 6.7 / 6.7 mm



J-32-2713
 18.5 cm / 7 1/4"
 6.7 / 6.7 mm



J-32-2720
 16 cm / 6 1/4"
 2.8 / 6.2 mm



J-32-2721
 16 cm / 6 1/4"
 2.8 / 6.2 mm



J-32-2730
 15 cm / 6"
 3.1 / 3.1 mm



J-32-2731
 17 cm / 6 3/4"
 5.6 / 5.6 mm

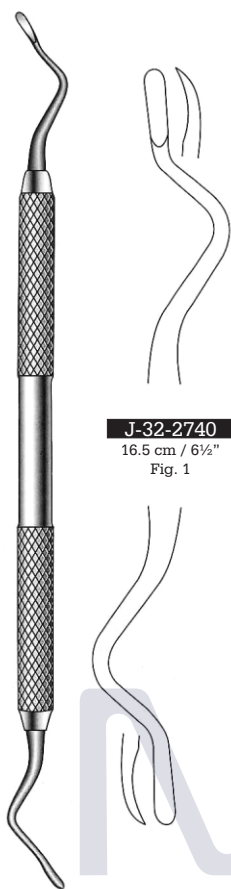

J-32-2740
16.5 cm / 6½"
Fig. 1

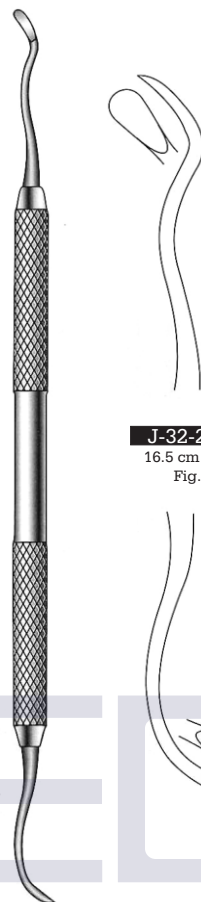

J-32-2741
16.5 cm / 6½"
Fig. 2

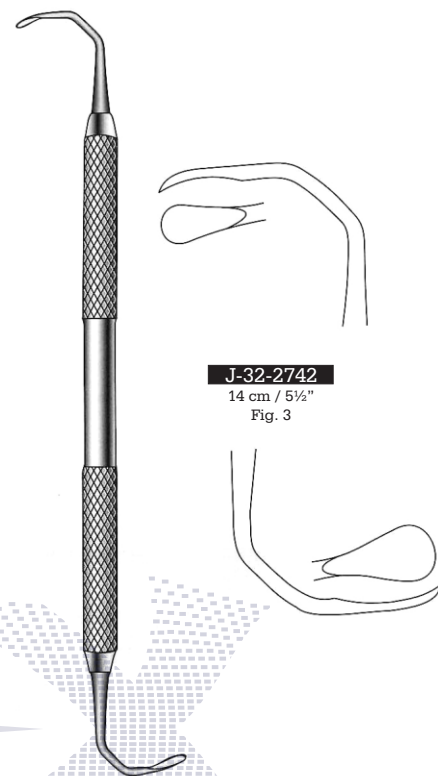

J-32-2742
14 cm / 5½"
Fig. 3

MEDIX
SURGICAL DISTRIBUTION

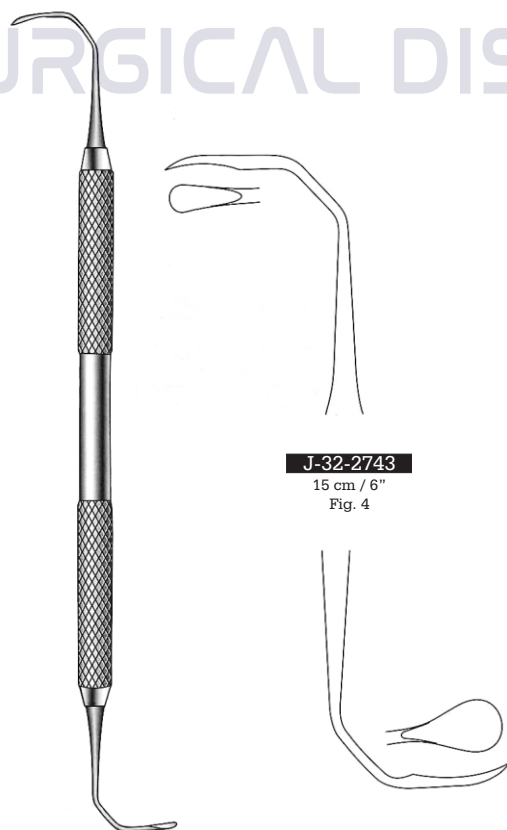

J-32-2743
15 cm / 6"
Fig. 4

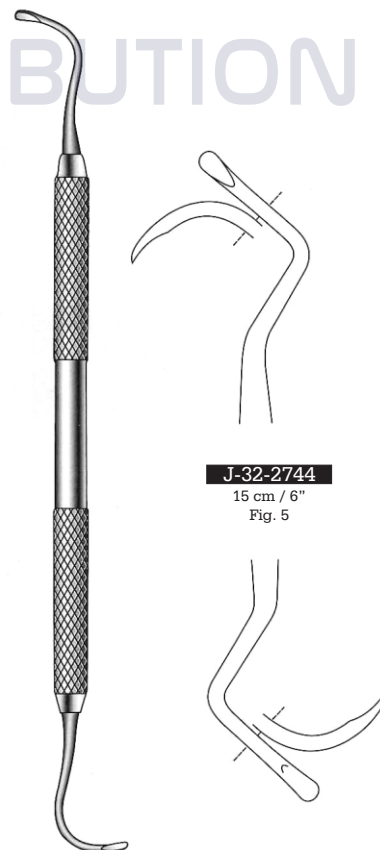

J-32-2744
15 cm / 6"
Fig. 5



Aufricht
 21 cm / 8 1/4"

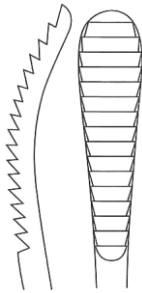

JO-21-191
 Single ended
 forward cutting
 32 x 9 mm width

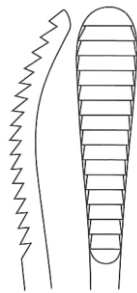

JO-21-192
 Single ended
 backward cutting
 9 mm width

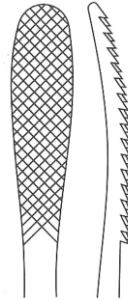

JO-21-5550
 Single ended
 backward cutting
 9 mm width

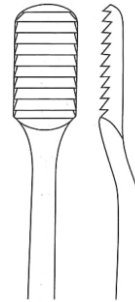

JO-21-195
 Fine, single ended
 8 mm width

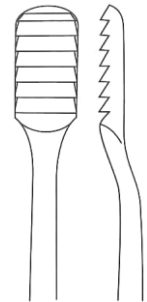

JO-21-196
 Coarse, single ended
 8 mm width
 Plain serrations



Lewis Rasp
 19 cm / 7 1/2"

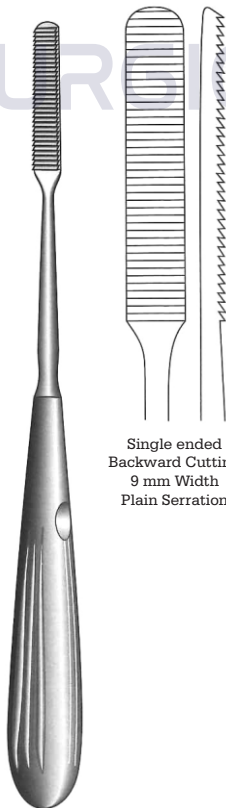

Cottle Rasp
JO-21-197
 20.5 cm / 8"

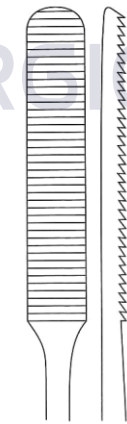

Single ended
 Backward Cutting
 9 mm Width
 Plain Serration

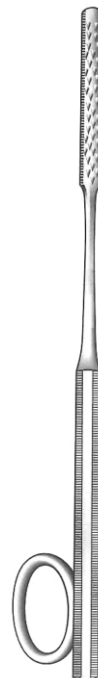

Gallaher
 17 cm / 6 3/4"



J-32-1535
 45 x 6 mm



J-32-1536
 45 x 6 mm

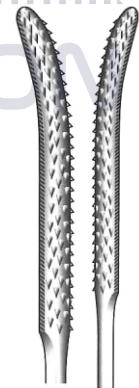

J-32-1537
 45 x 6 mm



Maltz
18 cm / 7"
Single ended
10 mm width

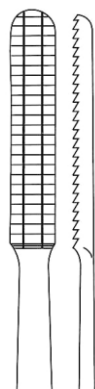

JO-21-193
34 x 7 mm
Backward cutting

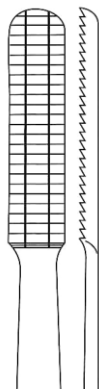

JO-21-1541
34 x 7 mm
Forward cutting



Wiener
18 cm / 7"

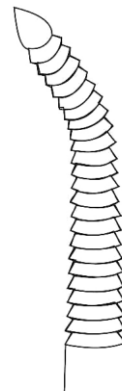

J-32-1520

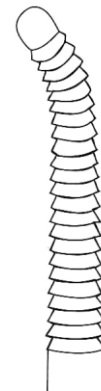

J-32-1530

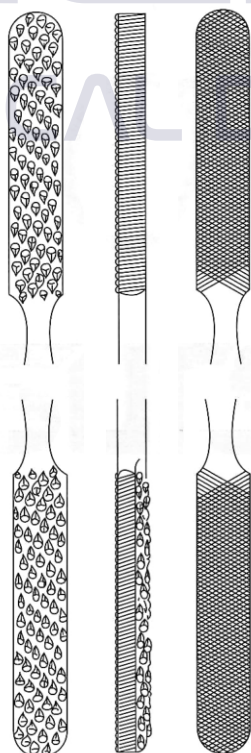

Fomon
JO-21-189
21 cm / 8 1/4"
Double ended, fine and
coarse teeth 4-side, convex and flat
blades 8 mm width

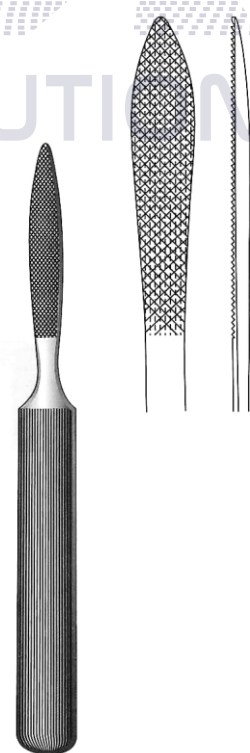

Joseph
JO-21-194
16 cm / 6 1/4"
60 x 8 mm
Single ended, 8 mm at wide
point, fine cross serrations

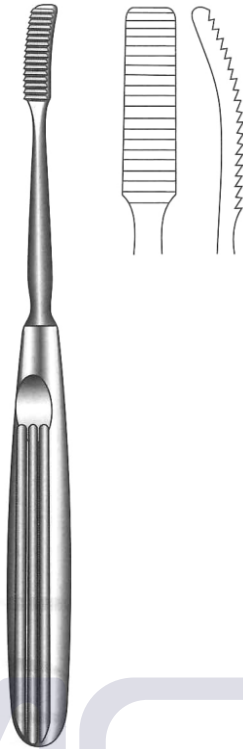

J-32-5400
 19.5 cm / 7 3/4"



Lewis
JT-32-5410
 19.5 cm / 7 3/4"

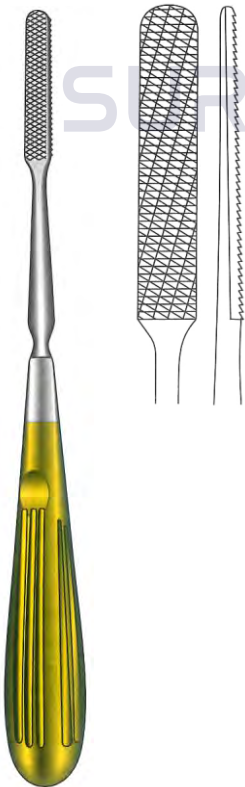

Cottle
JT-32-5390
 20.5 cm / 8"
 Straight

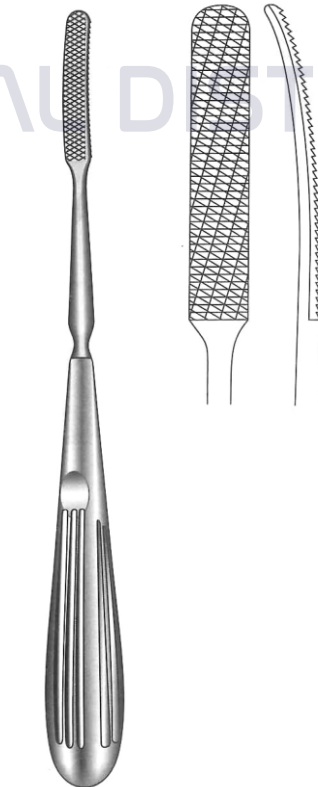

Cottle
J-32-5392
 20.5 cm / 8"
 Curved
 Downward Serration

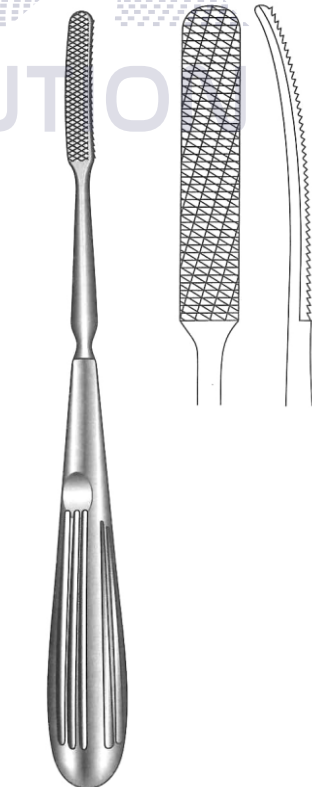

Cottle
J-32-5394
 20.5 cm / 8"
 Curved
 Half up & Half
 Downward Serration

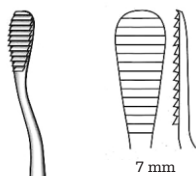

7 mm

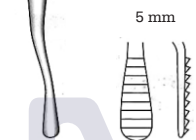

5 mm

Miller-Colburn

JO-21-198

18 cm / 7"

Double ended, plain serrations



Cross serrations

Plain serrations



Miller-Colburn

JO-21-199

18 cm / 7"

Double ended, 5 mm width

SURGICAL DISTRIBUTION

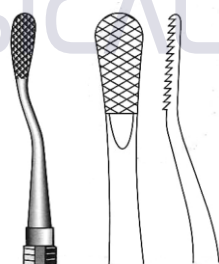

7 mm

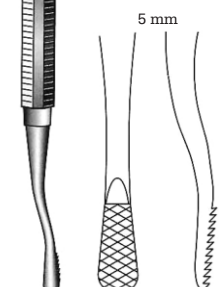

5 mm

Miller-Colburn

JO-21-200

18 cm / 7"

Double ended, cross serrations



Coarse serrations

Fine serrations

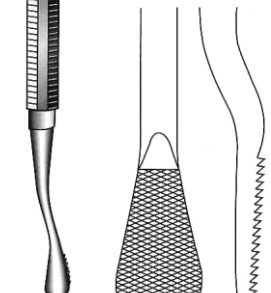

Miller-Colburn

JO-21-201

21.5 cm / 8½"

Double ended, 13 mm width
Cross serrations, for rapid shaping of bone

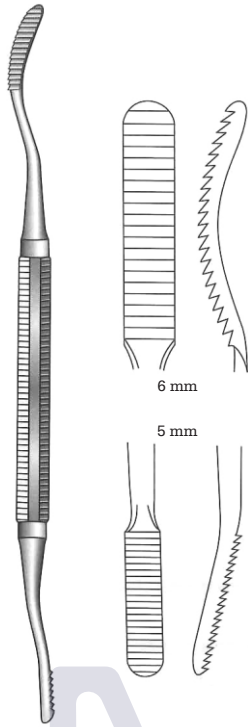

Miller-Colburn
JO-21-202
18.5 cm / 7¼"
Double ended, plain serrations

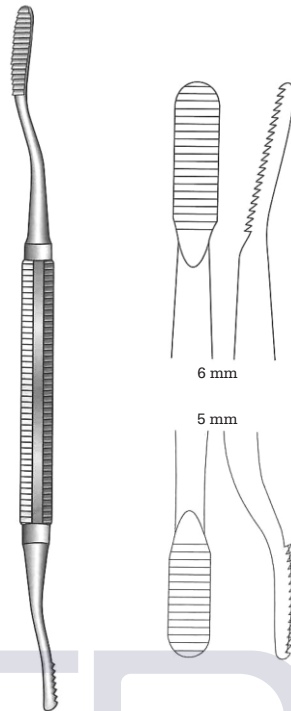

Miller-Colburn
JO-21-203
18 cm / 7"
Double ended, plain serrations

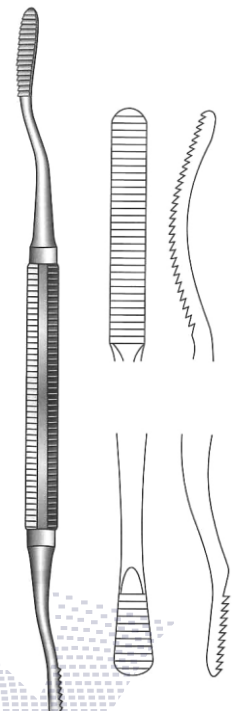

Miller-Colburn
JO-21-204
18 cm / 7"
Double ended, 5 mm width,
plain serrations

SURGICAL DISTRIBUTION

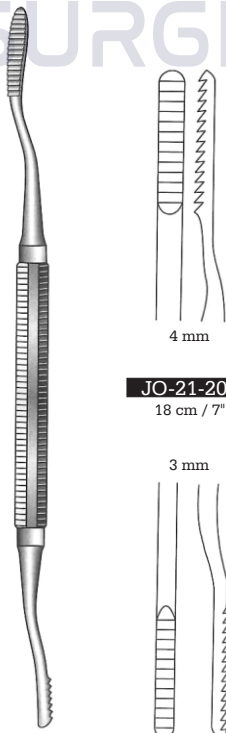

Polokoff Rasp
Double ended, plain serrations

JO-21-205
18 cm / 7"



JO-21-206
21.5 cm / 8½"
6 mm width

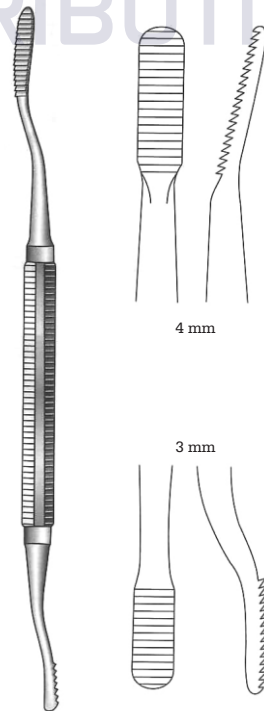

Miller-Colburn
JO-21-207
18 cm / 7"
Double ended

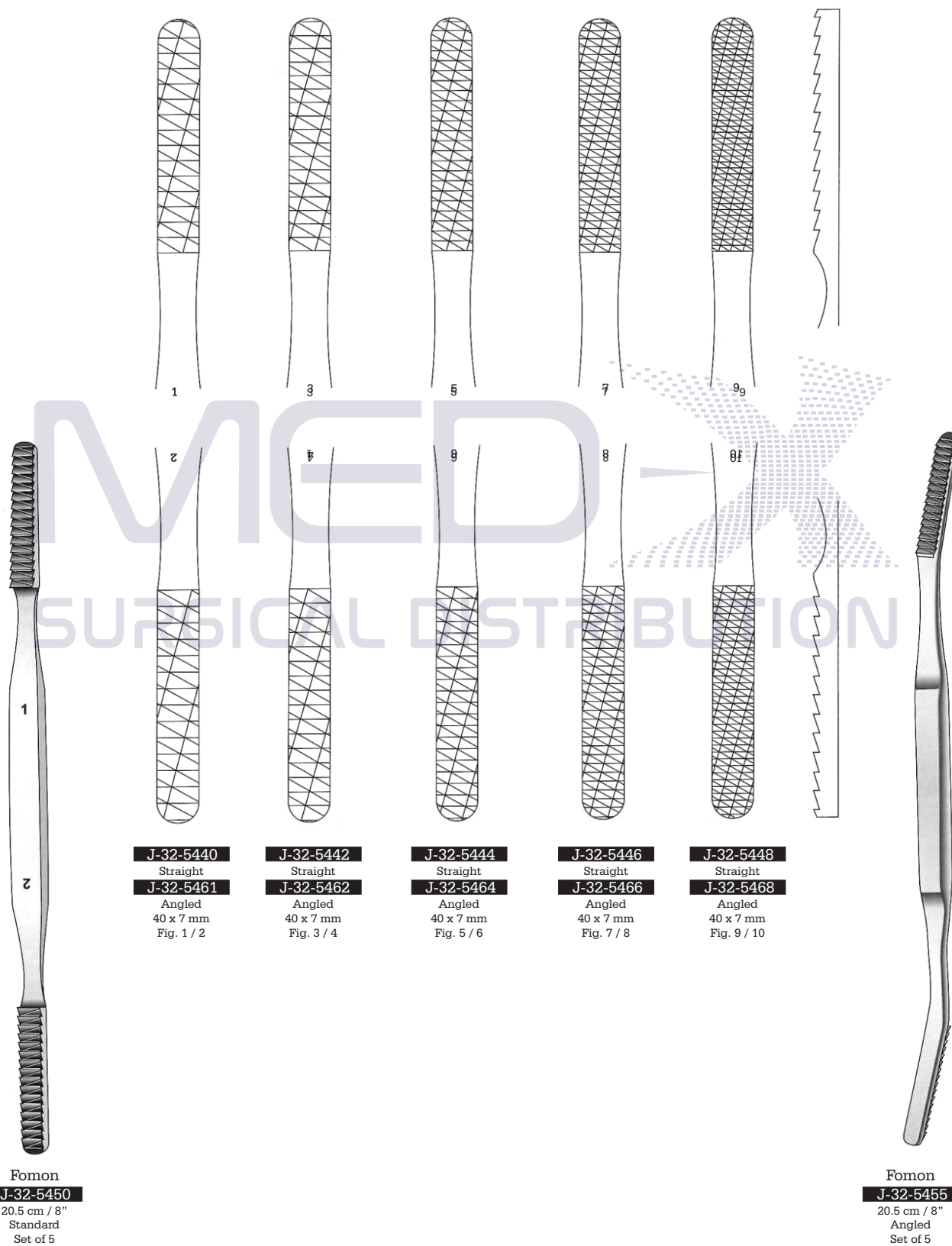

Fomon
J-32-5450
20.5 cm / 8"
Standard
Set of 5

Fomon
J-32-5455
20.5 cm / 8"
Angled
Set of 5

J-32-5440
Straight
J-32-5461
Angled
40 x 7 mm
Fig. 1 / 2

J-32-5442
Straight
J-32-5462
Angled
40 x 7 mm
Fig. 3 / 4

J-32-5444
Straight
J-32-5464
Angled
40 x 7 mm
Fig. 5 / 6

J-32-5446
Straight
J-32-5466
Angled
40 x 7 mm
Fig. 7 / 8

J-32-5448
Straight
J-32-5468
Angled
40 x 7 mm
Fig. 9 / 10

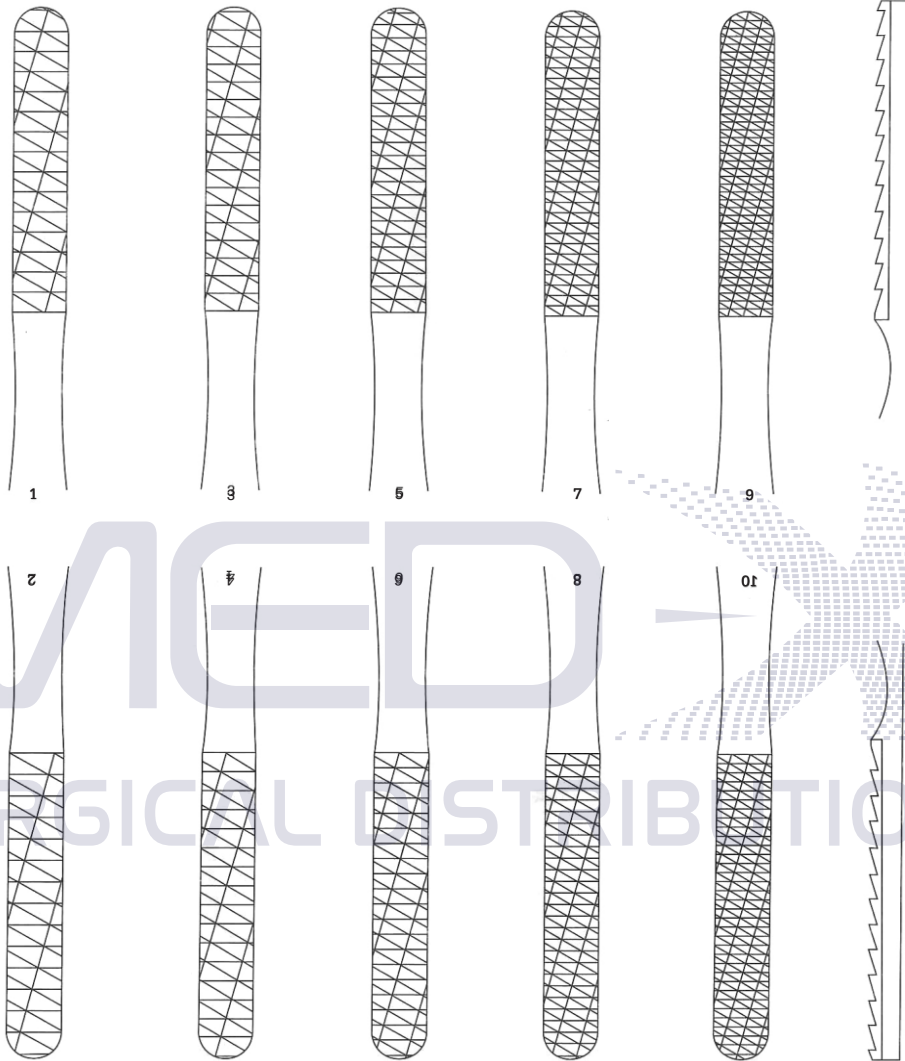

- | | | | | |
|---|---|---|---|--|
| JT-32-440
Straight | JT-32-442
Straight | JT-32-444
Straight | JT-32-446
Straight | JT-32-448
Straight |
| JT-32-550
Angled
40 x 7 mm
Fig. 1 / 2 | JT-32-552
Angled
40 x 7 mm
Fig. 3 / 4 | JT-32-554
Angled
40 x 7 mm
Fig. 5 / 6 | JT-32-556
Angled
40 x 7 mm
Fig. 7 / 8 | JT-32-558
Angled
40 x 7 mm
Fig. 9 / 10 |



Fomon
JT-32-559
 20.5 cm / 8"
 Angled
 with TC Inserts
 Set of 5



Fomon
JT-32-449
 20.5 cm / 8"
 Standard
 with TC Inserts
 Set of 5



Obwegeser
19.5 cm / 7 3/4"

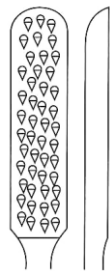

J-32-5421
Straight
Fine



J-32-5423
Curved
Fine

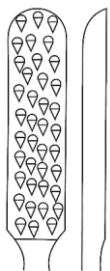

J-32-5426
Straight
Semi fine

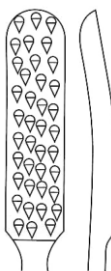

J-32-5428
Curved
Semi fine

One working end of the rasp
operates by pushing, the other
by pulling.



Obwegeser
19.5 cm / 7 3/4"

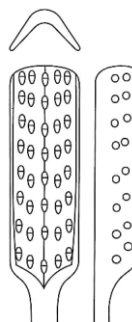

J-32-5431
Fine

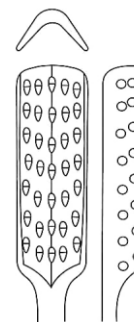

J-32-5432
Semi fine

Bone Splinters Are Pushed
Through The Perforated Working Ends.
This Avoids Plugging Of The Rasps
And They Can Be Cleaned Easily.



Converse
J-32-5460
18.5 cm / 7 1/4"
Nasal file

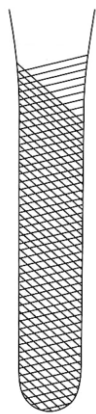
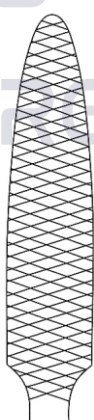

Masing
J-32-5470
21 cm / 8 1/4"
Nasal file

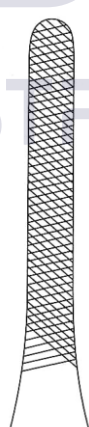

Masing
J-32-5465
21 cm / 8 1/4"
Nasal rasp

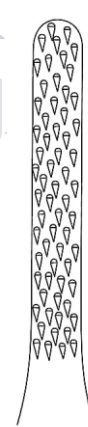



- JO-21-4800** Ø = 35 mm, 150 g
- JO-21-4802** Ø = 45 mm, 240 g
- JO-21-4804** Ø = 50 mm, 330 g

26 cm / 10¼"
 Made of NOVOTEX plastic
 (autoclavable up to 134° cat 3 bar)

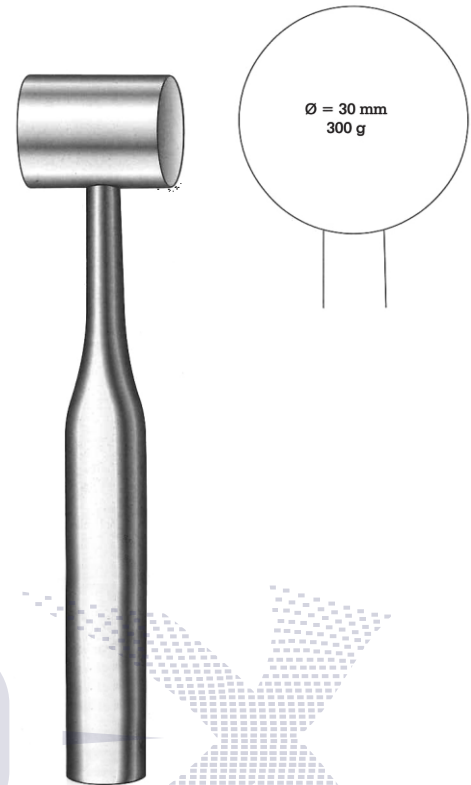

Cottle
JO-21-4820
 19 cm / 7½"

MED SURGICAL DISTRIBUTION



Collin
JO-21-157
 20 cm / 8"
 220 gm / 7¾ oz
 30 mm Ø



Doyen
 21 cm / 8¼"

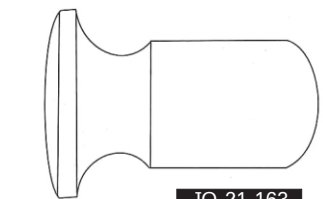

JO-21-163
 25 mm Ø
 120 gm / 4½ oz

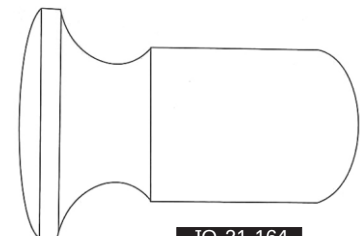

JO-21-164
 30 mm Ø
 180 gm / 6½ oz

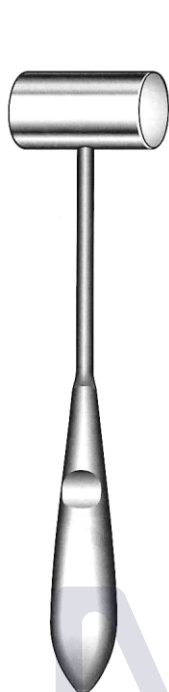

JO-21-156
16.5 cm / 6½"
140 gm / 5 oz
20 mm Ø

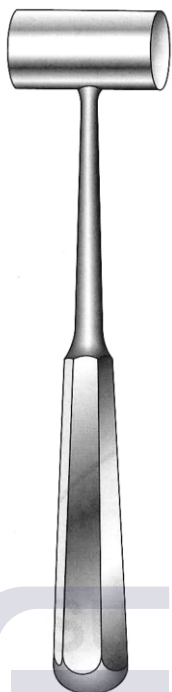

Partsch
22 mm Ø
JO-21-168
18 cm / 7"
200 gm
JO-21-1520
16 cm / 6¼"
165 gm
JO-21-1521
18 cm / 7"
220 gm

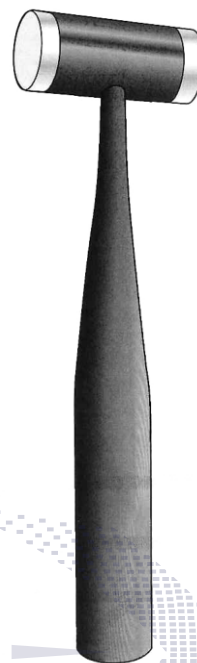

Detachable Heads
Autoclavable to
250°F (121°C)

Mallet Lightweight
19 cm / 7½"
25 mm Ø
JO-21-1525
140 gm
JO-21-170
Two replaceable nylon caps
Total weight: 7 oz.
Head weight: 4 oz

SURGICAL DISTRIBUTION

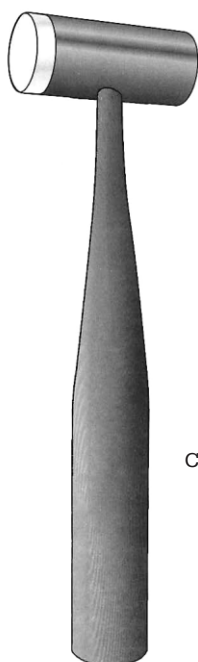

Autoclavable to
250°F (121°C)

Combination Mallet
19 cm / 7½"
JO-21-171
Total weight: 9 oz
Head weight: 5 oz
26 mm Ø
JO-21-172
Total weight: 12 oz
Head weight: 8 oz
38 mm Ø
One side nylon cap



JO-21-2230
Medium size hammer
Full aluminum
Total weight 200 gm

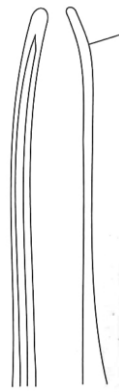
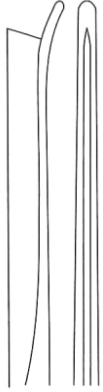

Silver
J-32-1571 2 mm
J-32-5850 3 mm
J-32-5851 4 mm
 18 cm / 7"
 Straight

Silver
J-32-1572 2 mm
J-32-5854 3 mm
J-32-5855 4 mm
 18 cm / 7"
 Right

Silver
J-32-1573 2 mm
J-32-5858 3 mm
J-32-5859 4 mm
 18 cm / 7"
 Left

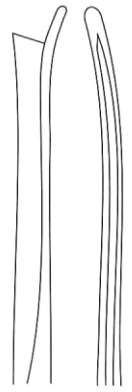

Silver Chisel Osteotome
J-32-5860 2 mm
J-32-5862 3 mm
J-32-5864 4 mm
 18 cm / 7", Straight

Silver Chisel Osteotome
J-32-5870 2 mm
J-32-5872 3 mm
J-32-5874 4 mm
 18 cm / 7", Left

Silver Chisel Osteotome
J-32-5880 2 mm
J-32-5882 3 mm
J-32-5884 4 mm
 18 cm / 7", Right



Marchas Osteotome
J-32-5890 2 mm
J-32-5892 3 mm
J-32-5894 4 mm
 Straight



Marchas Osteotome
J-32-5900 2 mm
J-32-5902 3 mm
J-32-5904 4 mm
 Left



Marchas Osteotome
J-32-5910 2 mm
J-32-5912 3 mm
J-32-5914 4 mm
 Right



Neivert-Andreson
J-32-5920
 20.5 cm, 4mm
 Left



Neivert-Andreson
J-32-5930
 20.5 cm, 4mm
 Right



Bauer
 20.5 cm / 8"

Bauer
 20.5 cm / 8"

Epker Bauer
 J-32-2830
 17.5 cm / 7"
 8 mm

SURGICAL DISTRIBUTION

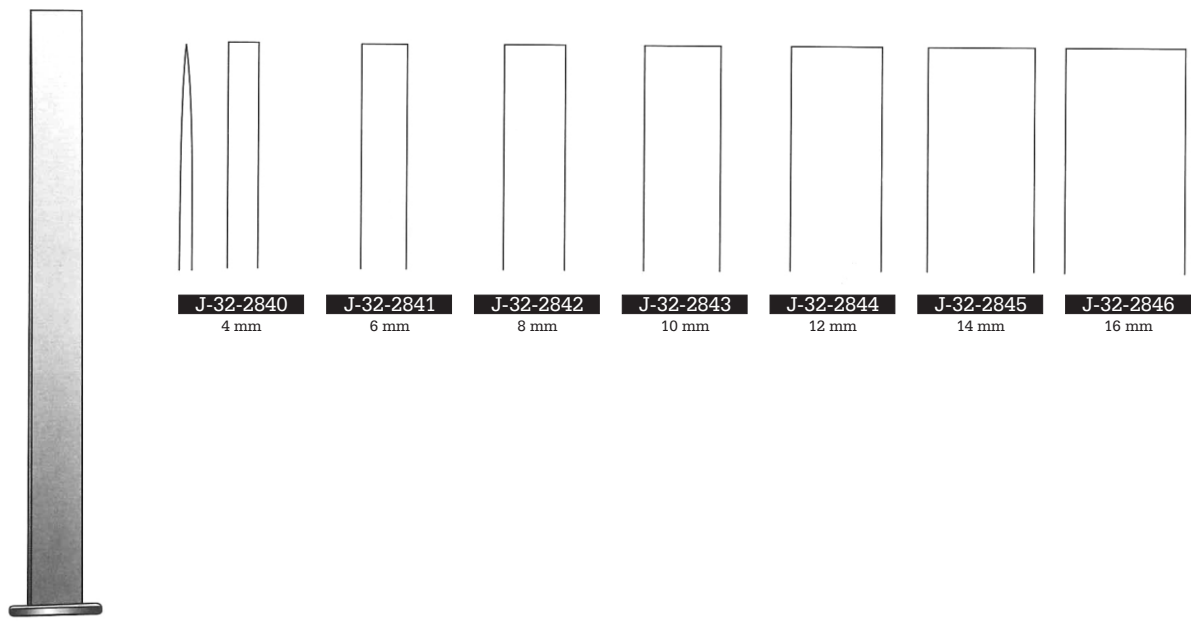

Dautrey Munro
 16 cm / 6 1/4"

J-32-2840 4 mm J-32-2841 6 mm J-32-2842 8 mm J-32-2843 10 mm J-32-2844 12 mm J-32-2845 14 mm J-32-2846 16 mm



MEDIX
SURGICAL DISTRIBUTION

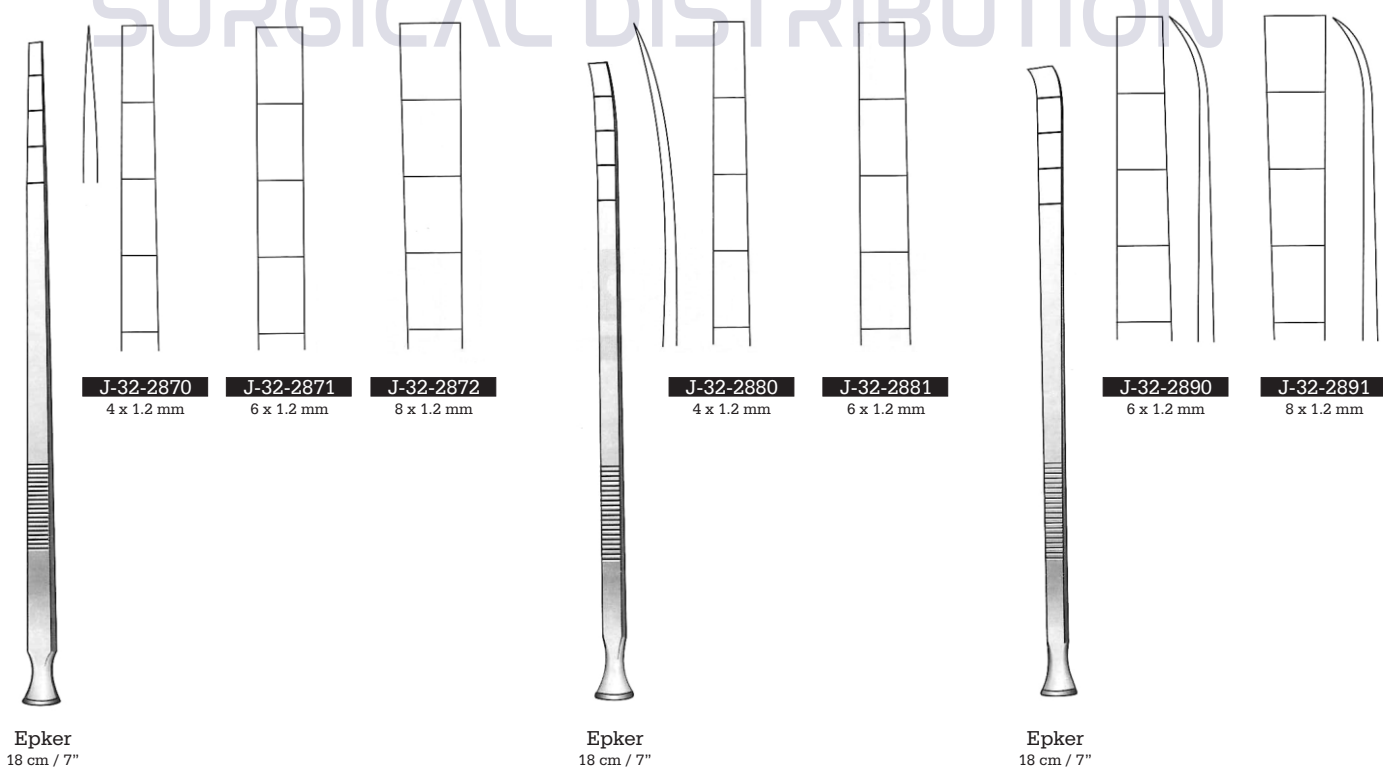

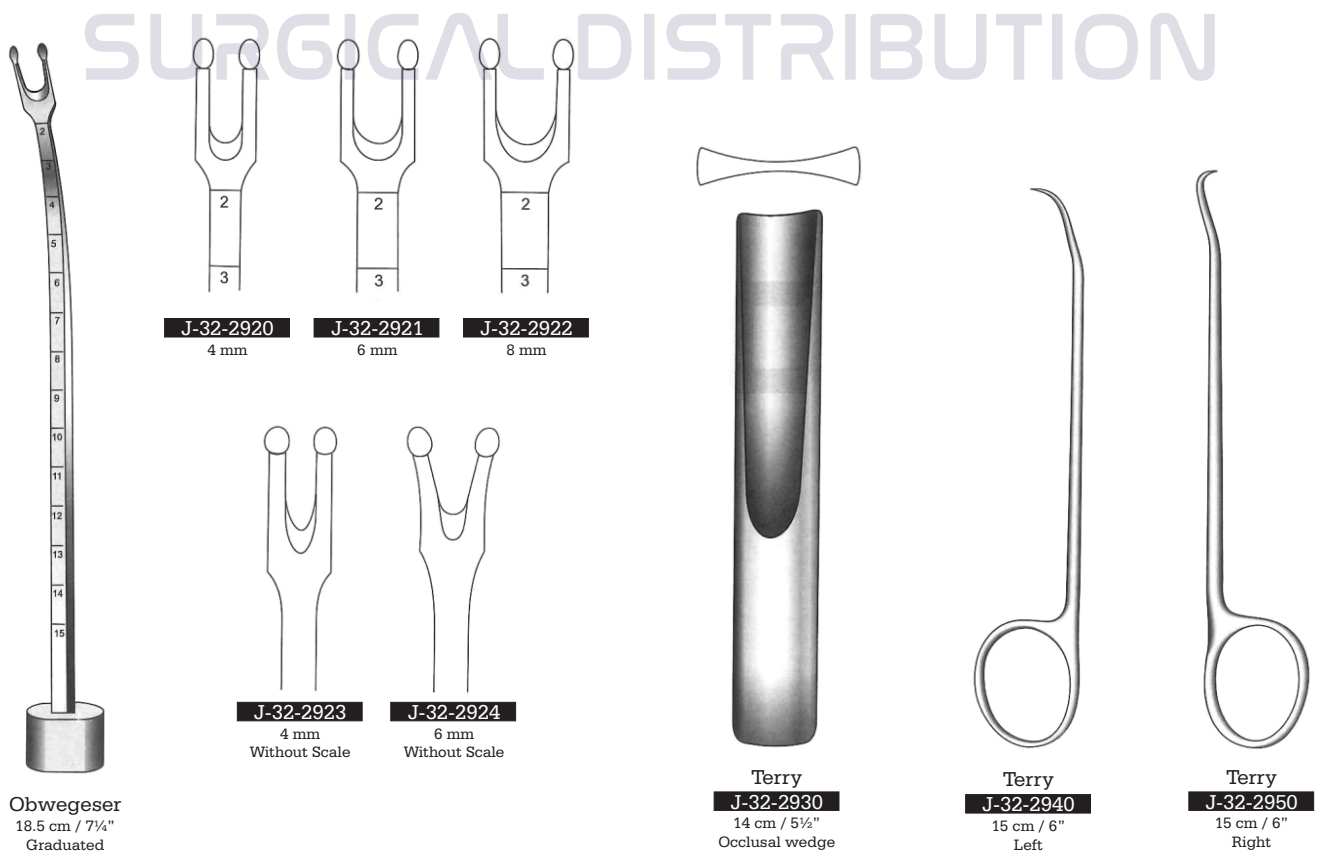



Silver Chisel Osteotome

- J-32-5940 2 mm
 - J-32-5942 3 mm
 - J-32-5944 4 mm
- 18.5 cm / 7 1/4"
Straight

Silver Chisel Osteotome

- J-32-5950 2 mm
 - J-32-5952 3 mm
 - J-32-5954 4 mm
- 18.5 cm / 7 1/4"
Right

Silver Chisel Osteotome

- J-32-5960 2 mm
 - J-32-5962 3 mm
 - J-32-5964 4 mm
- 18.5 cm / 7 1/4"
Left



5 mm

12 mm



J-32-5970

J-32-5972

Cottle-Gubisch
18 cm / 7"
Graduated, Hollow Cut

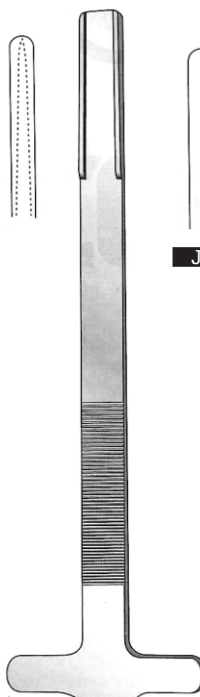

12 mm

14 mm

16 mm

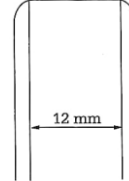
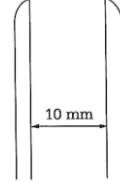
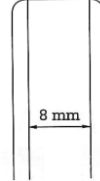

J-32-5980

J-32-5982

J-32-5984

Rubin
18 cm / 7"

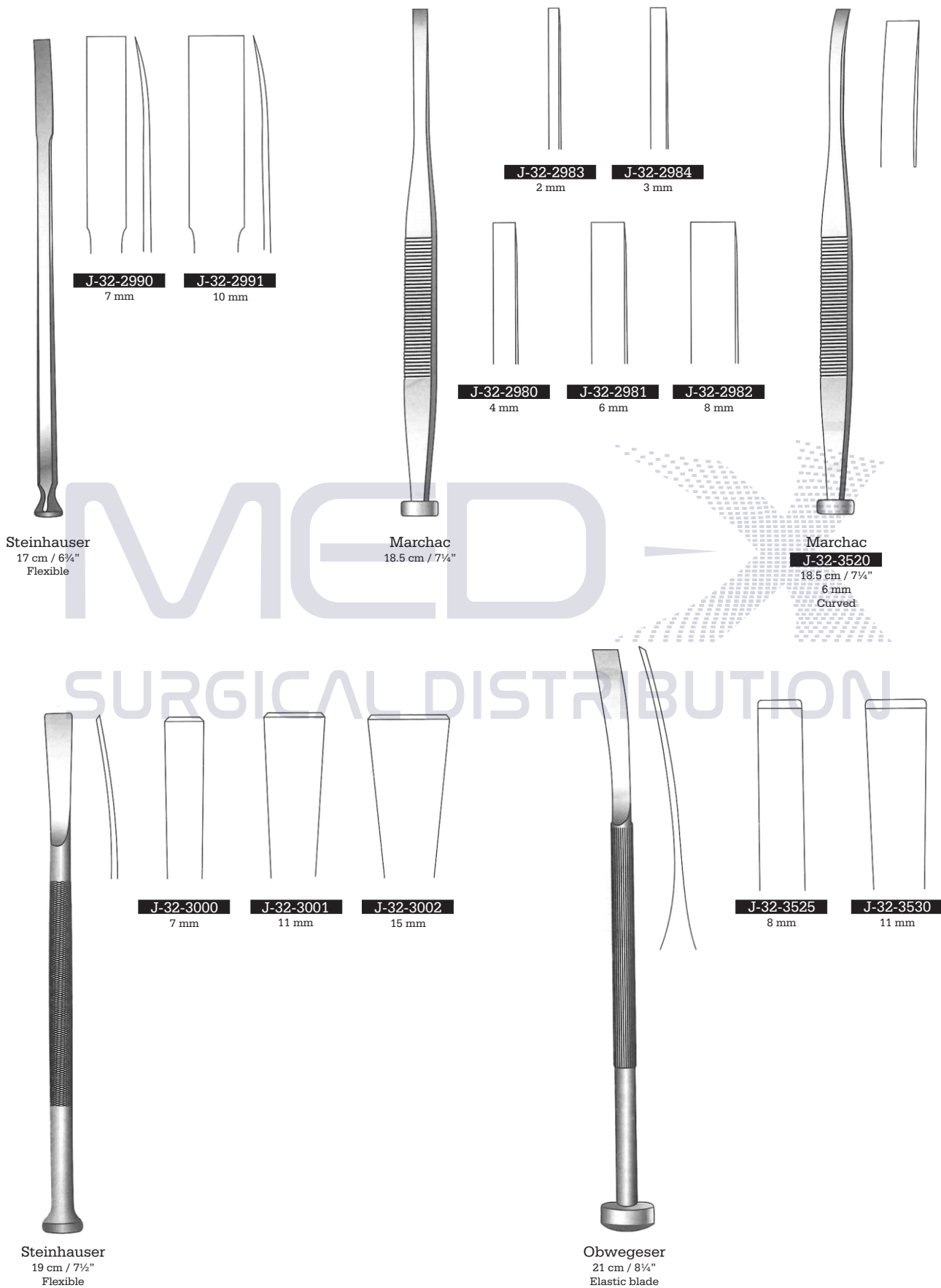



Walter
19 cm / 7½"

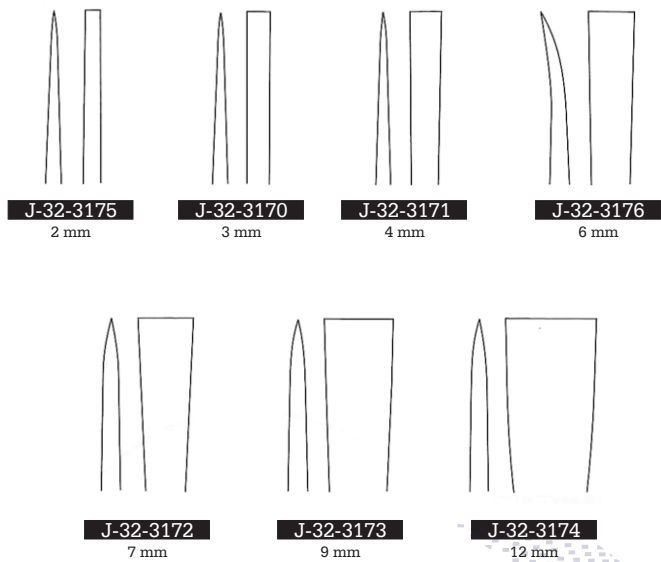

MEDIX
SURGICAL DISTRIBUTION

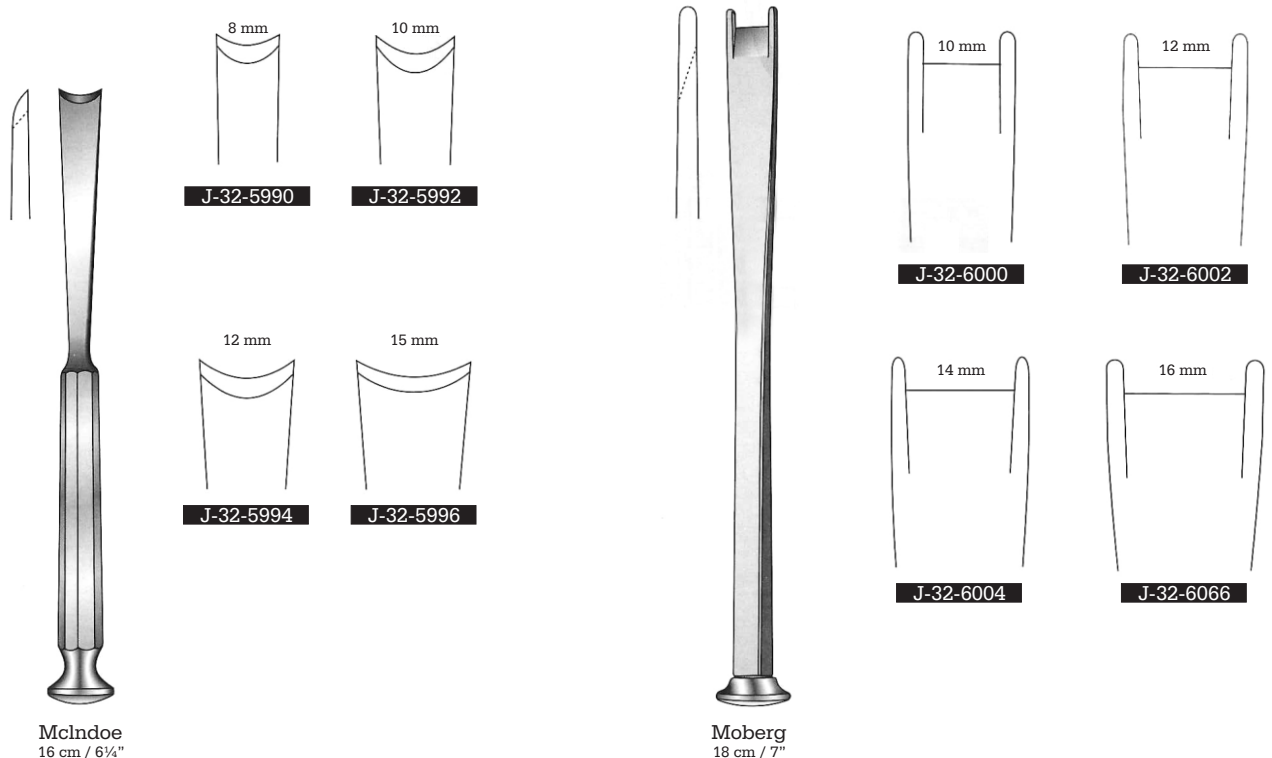

McIndoe
16 cm / 6¼"

Moberg
18 cm / 7"

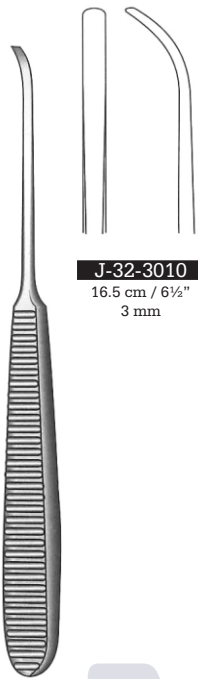

J-32-3010
 16.5 cm / 6½"
 3 mm

Steinhauser

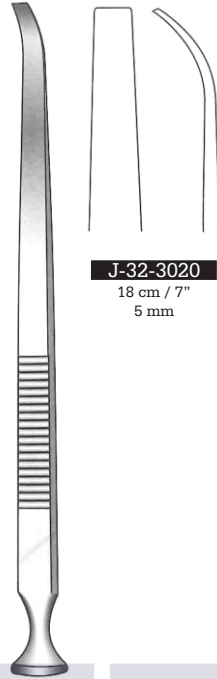

J-32-3020
 18 cm / 7"
 5 mm

Steinhauser

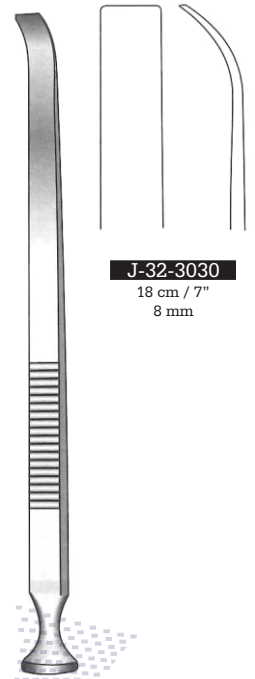

J-32-3030
 18 cm / 7"
 8 mm

Steinhauser



J-32-3040
 6 mm

Wolford
 23 cm / 9"

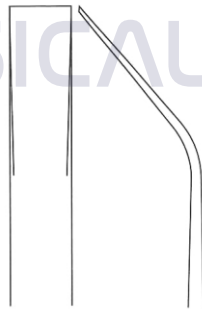
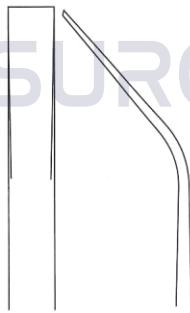

J-32-3041
 8 mm

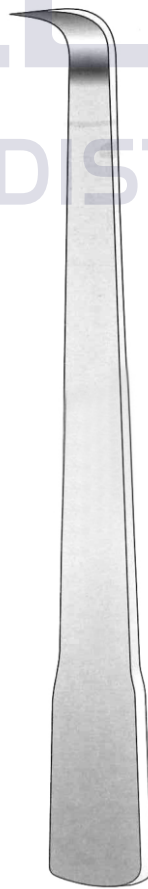

J-32-2970
 23 cm / 9"
 12 mm

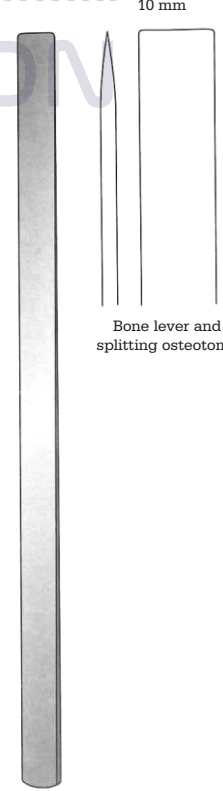
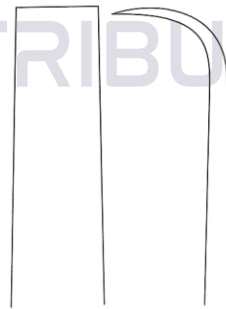

J-32-6040
 20 cm / 8"

10 mm
 Bone lever and
 splitting osteotome

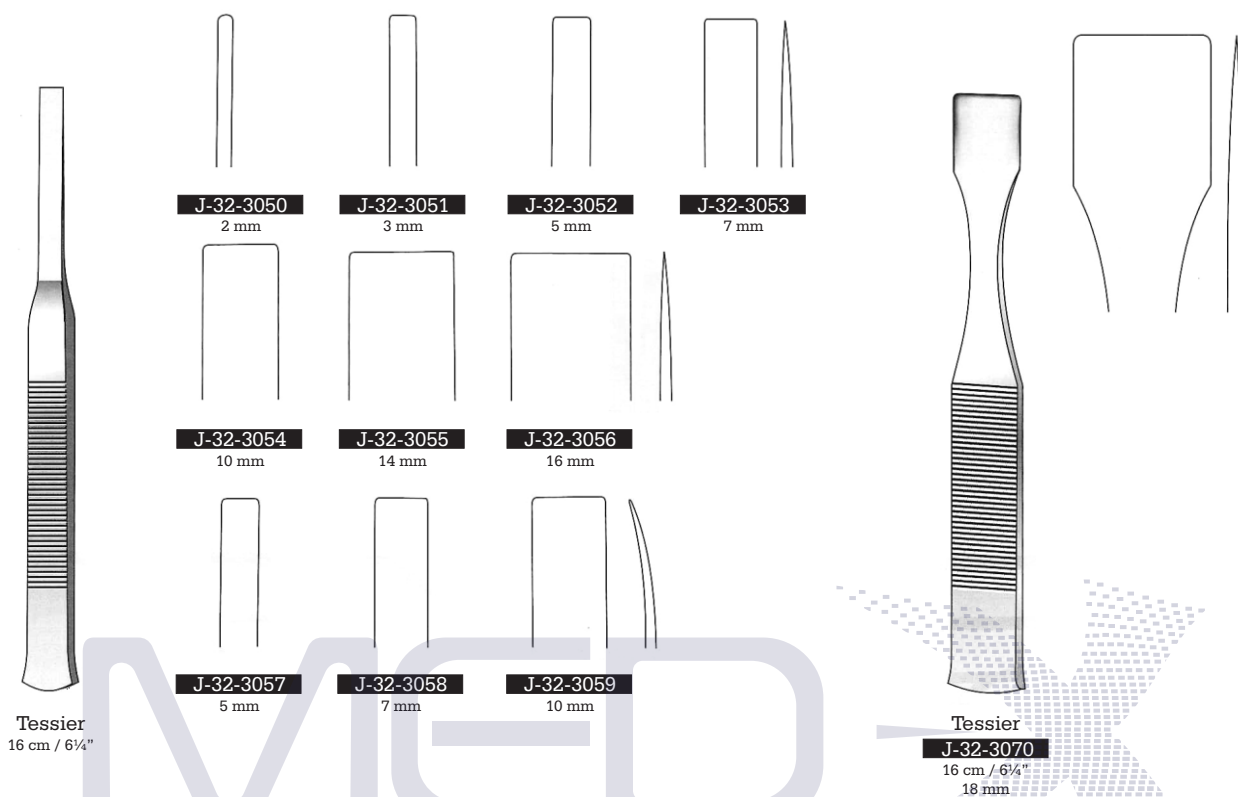

Tessier
16 cm / 6 1/4"

Tessier
J-32-3070
16 cm / 6 1/4"
18 mm

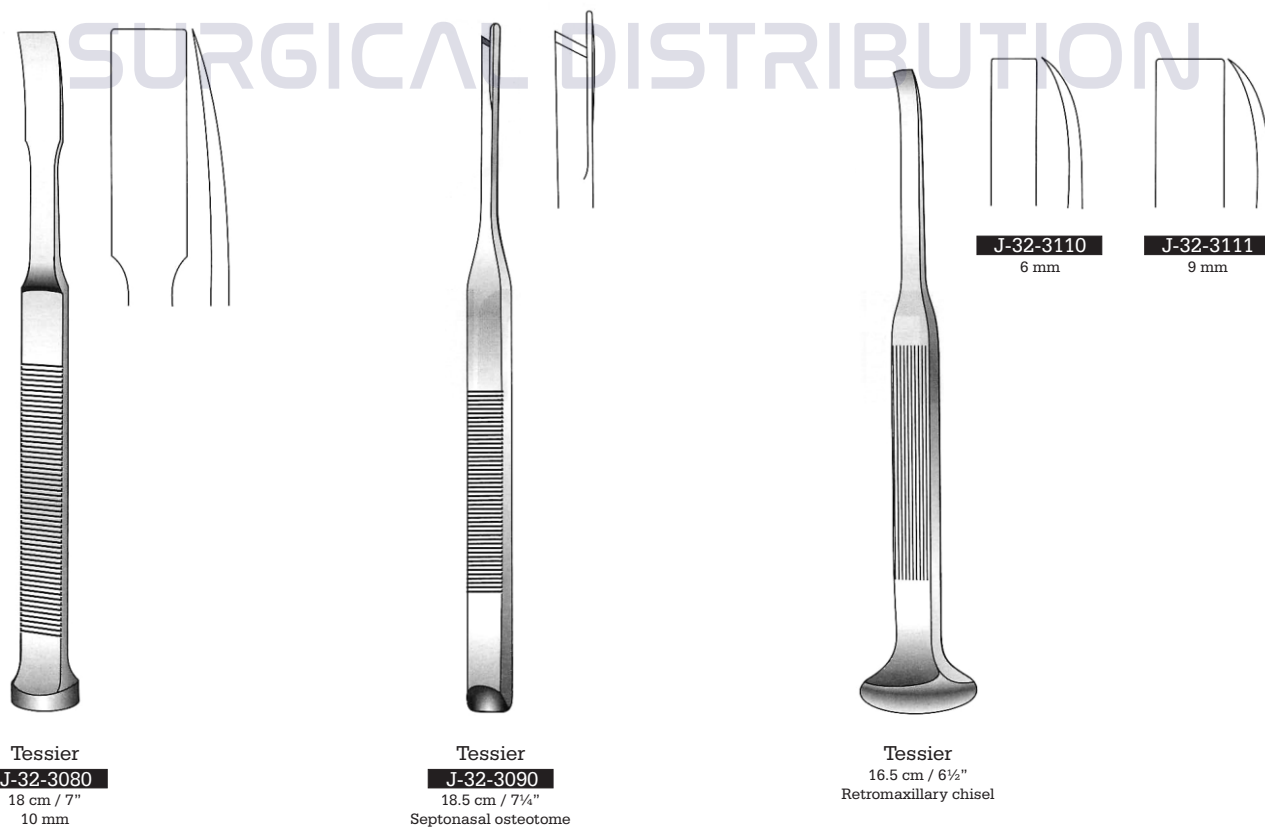

Tessier
J-32-3080
18 cm / 7"
10 mm

Tessier
J-32-3090
18.5 cm / 7 1/4"
Septonasal osteotome

Tessier
16.5 cm / 6 1/2"
Retromaxillary chisel



Schrom
19.5 cm / 7 3/4"

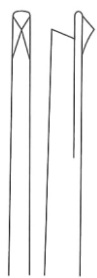

J-32-6030
Straight

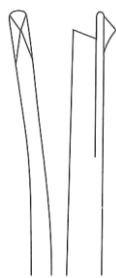

J-32-6032
Left, Curved

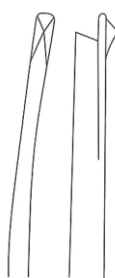

J-32-6034
Right, Curved

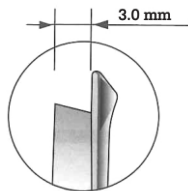

Fanous
19.5 cm / 7 3/4"



J-32-6020
Straight



J-32-6022
Left, Curved

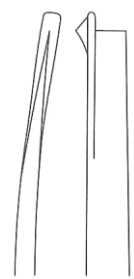

J-32-6024
Right, Curved

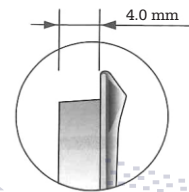

Fanous-Gubisch
J-32-6010
19.5 cm / 7 3/4"
Narrow

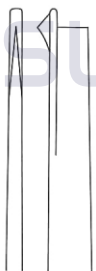

Thorn



Blume
J-32-6045
18 cm / 7 1/4"

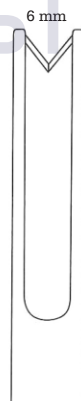
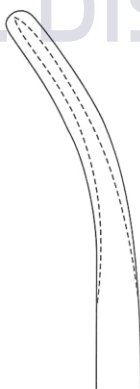

6 mm



Gubisch
18.5 cm / 7 1/4"



JO-21-4840
Fiber Handle
JO-21-4830
Ferrozell Handle



JO-21-4842
Fiber Handle
JO-21-2609A
Ferrozell Handle

2 mm

3 mm

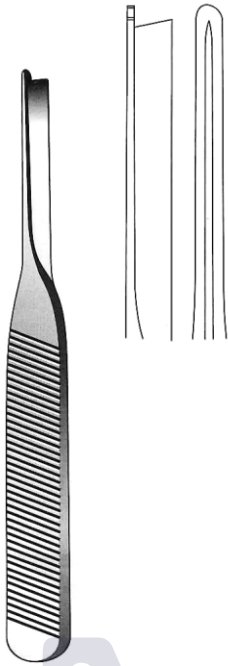

Parkes
J-32-2800
16 cm / 6 1/4"

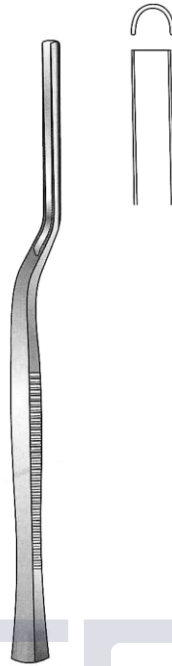

Killian
J-32-1410
16 cm / 6 1/4"
5 mm

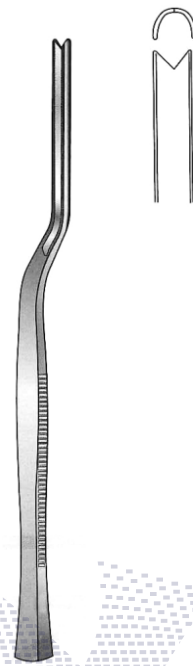

Killian-Claus
J-32-1420
16 cm / 6 1/4"
5 mm

SURGICAL DISTRIBUTION

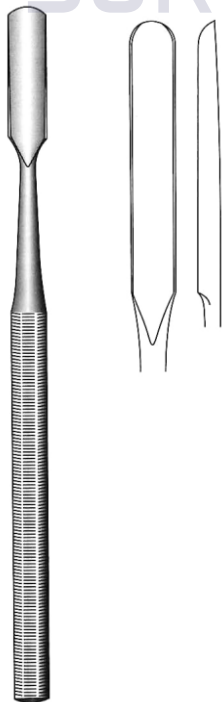

Freer
15 cm / 6"
Septum gouges

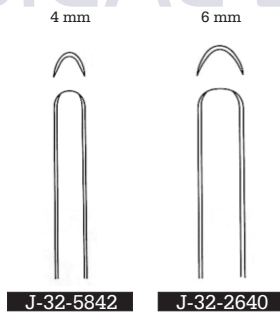

J-32-5842 J-32-2640

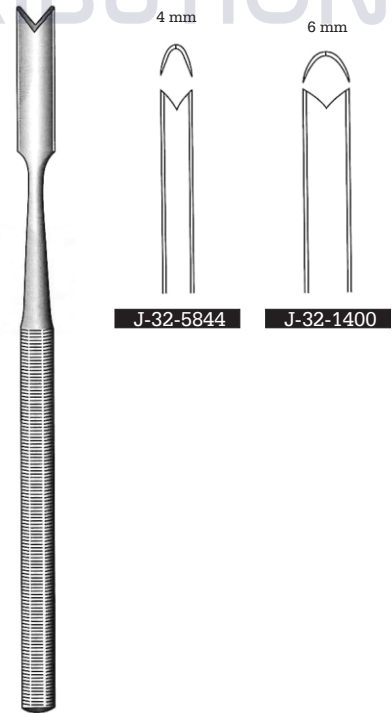

Ballenger
15 cm / 6"



J-32-1574
4 mm



J-32-1575
7 mm

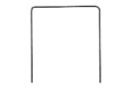

J-32-1576
9 mm



J-32-1577
12 mm

Cottle
18 cm / 7"
Osteotome

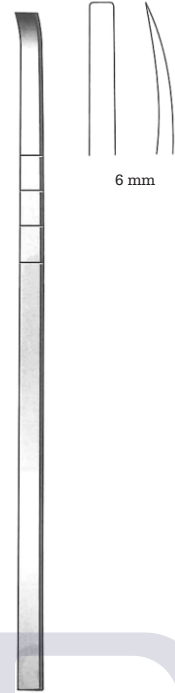

6 mm

Cottle
J-32-1578
18 cm / 7"
Osteotome

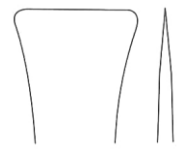

16 mm

Cottle
J-32-1585
18 cm / 7"
Fishtail osteotome
Very delicate

SURGICAL DISTRIBUTION

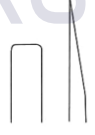
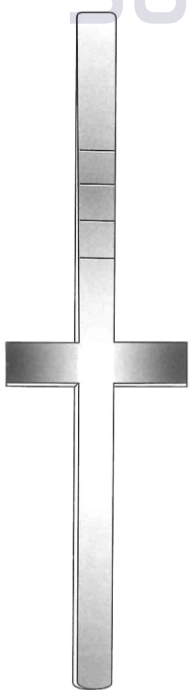

J-32-1579
4 mm



J-32-1581
7 mm



J-32-1582
9 mm



J-32-1583
12 mm

Cottle
18 cm / 7"
T Handle osteotome
Very delicate



6 mm

Cottle
J-32-1584
18 cm / 7"

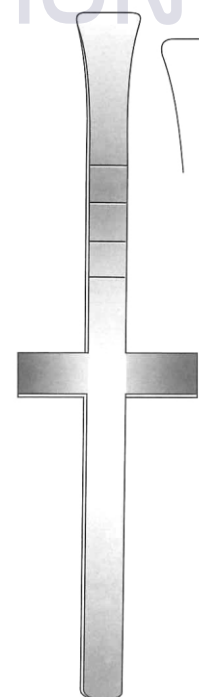

16 mm

Cottle
J-32-1586
18 cm / 7"



Neivert-Anderson
20.5 cm / 8"

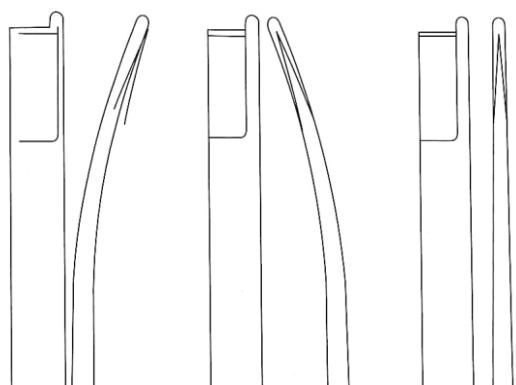

J-32-3670 4 mm	J-32-3680 4 mm	J-32-3690 4 mm
J-32-3675 7 mm	J-32-3685 7 mm	J-32-3695 7 mm



Fomon
17 cm / 6 3/4"

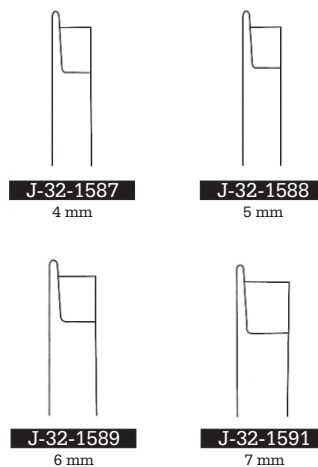

J-32-1587 4 mm	J-32-1588 5 mm
J-32-1589 6 mm	J-32-1591 7 mm

MED
SURGICAL DISTRIBUTION



Sheehan
15 cm / 6"



J-32-3130 1 mm	J-32-3131 2 mm	J-32-3132 3 mm	J-32-3133 4 mm	J-32-3134 5 mm
J-32-3135 6 mm	J-32-3136 7 mm	J-32-3137 8 mm	J-32-3138 10 mm	J-32-3139 12 mm



Cinelli
16 cm / 6 1/4"
Osteotome
Double guarded

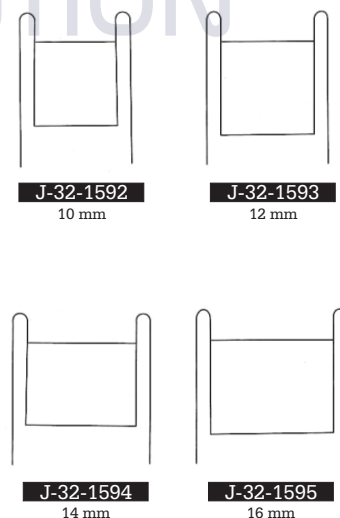

J-32-1592 10 mm	J-32-1593 12 mm
J-32-1594 14 mm	J-32-1595 16 mm

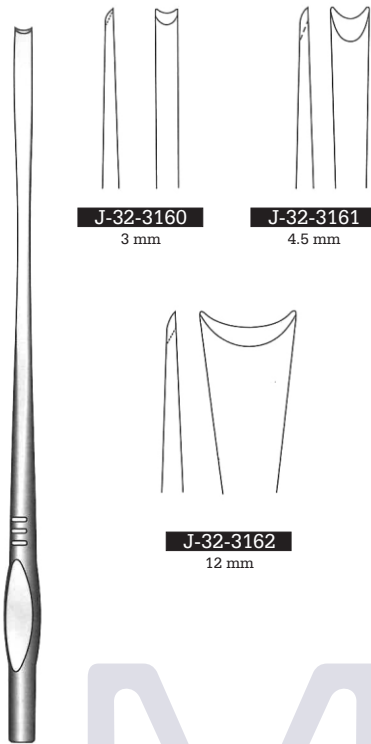

J-32-3160
3 mm

J-32-3161
4.5 mm



J-32-3162
12 mm

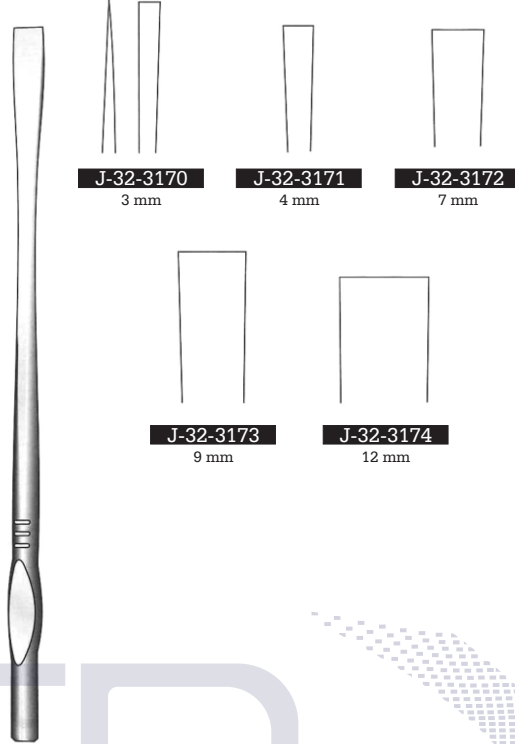

J-32-3170
3 mm

J-32-3171
4 mm

J-32-3172
7 mm

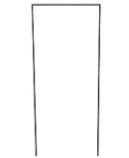

J-32-3173
9 mm

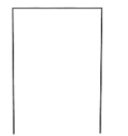

J-32-3174
12 mm

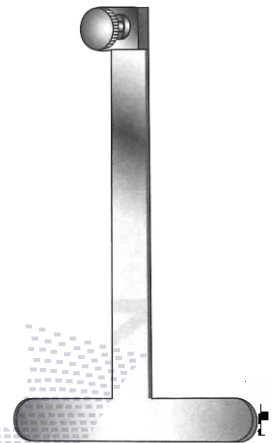

Cottle
J-32-3180
 12 cm / 4 3/4"
 Handle

Walter
 19 cm / 7 1/2"

Walter
 19 cm / 7 1/2"

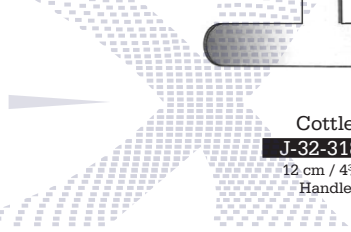
MED 
 SURGICAL DISTRIBUTION



Rubin
 18.5 cm / 7 1/4"
 Osteotomes



J-32-3150
10 mm



J-32-3151
12 mm



J-32-3152
14 mm



J-32-3153
16 mm

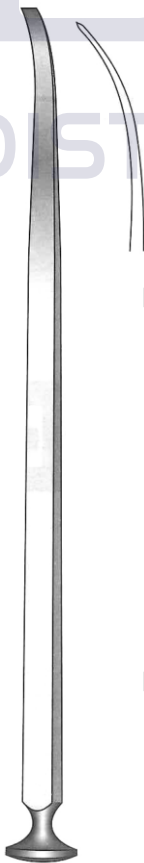

Steinhäuser
 22.5 cm / 9"
 Orbital osteotomes



JO-21-5570
10 mm



JO-21-5572
10 mm

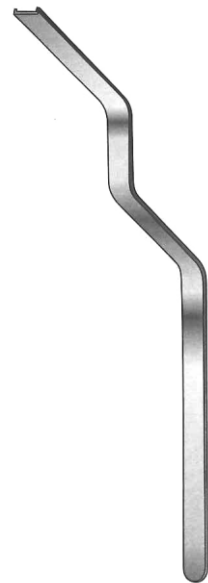

Cottle
J-32-3190
 7 mm width
 Guide support for osteotomes

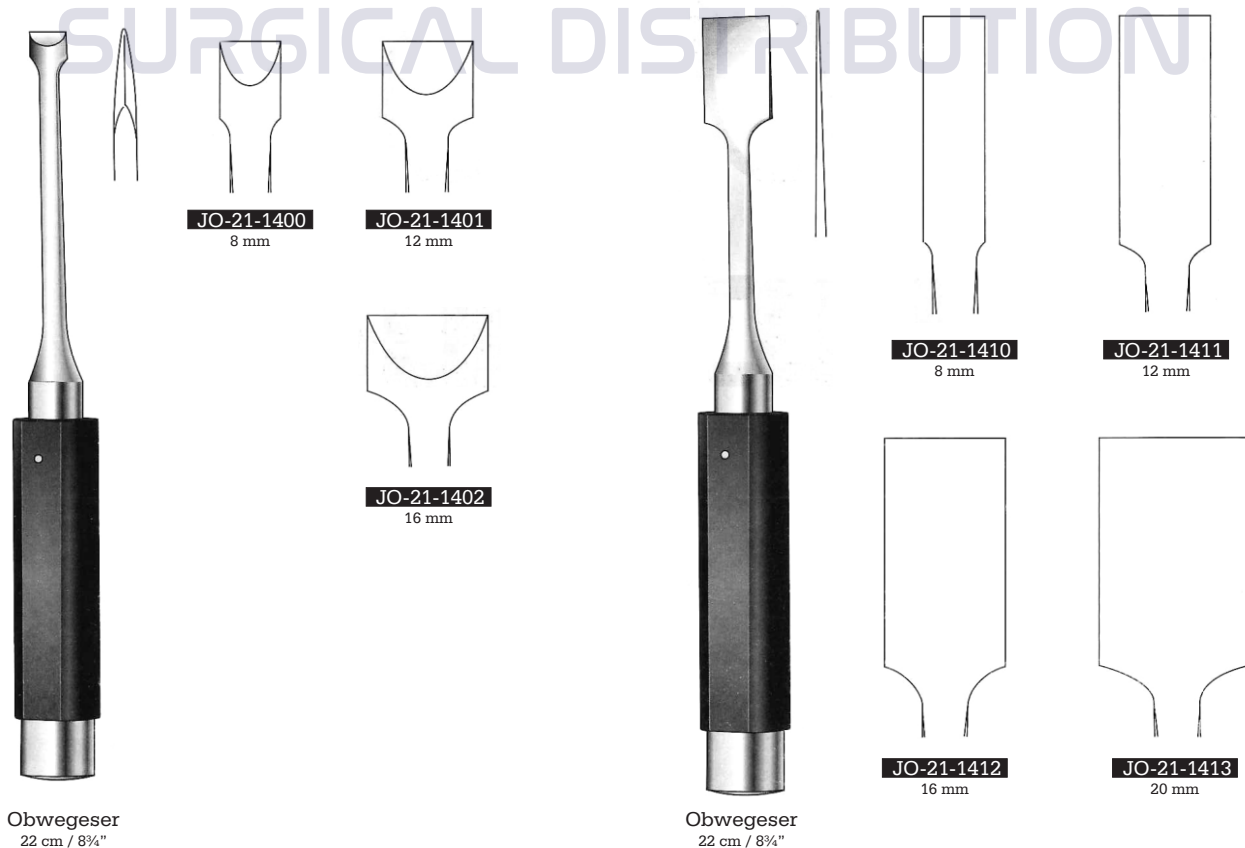
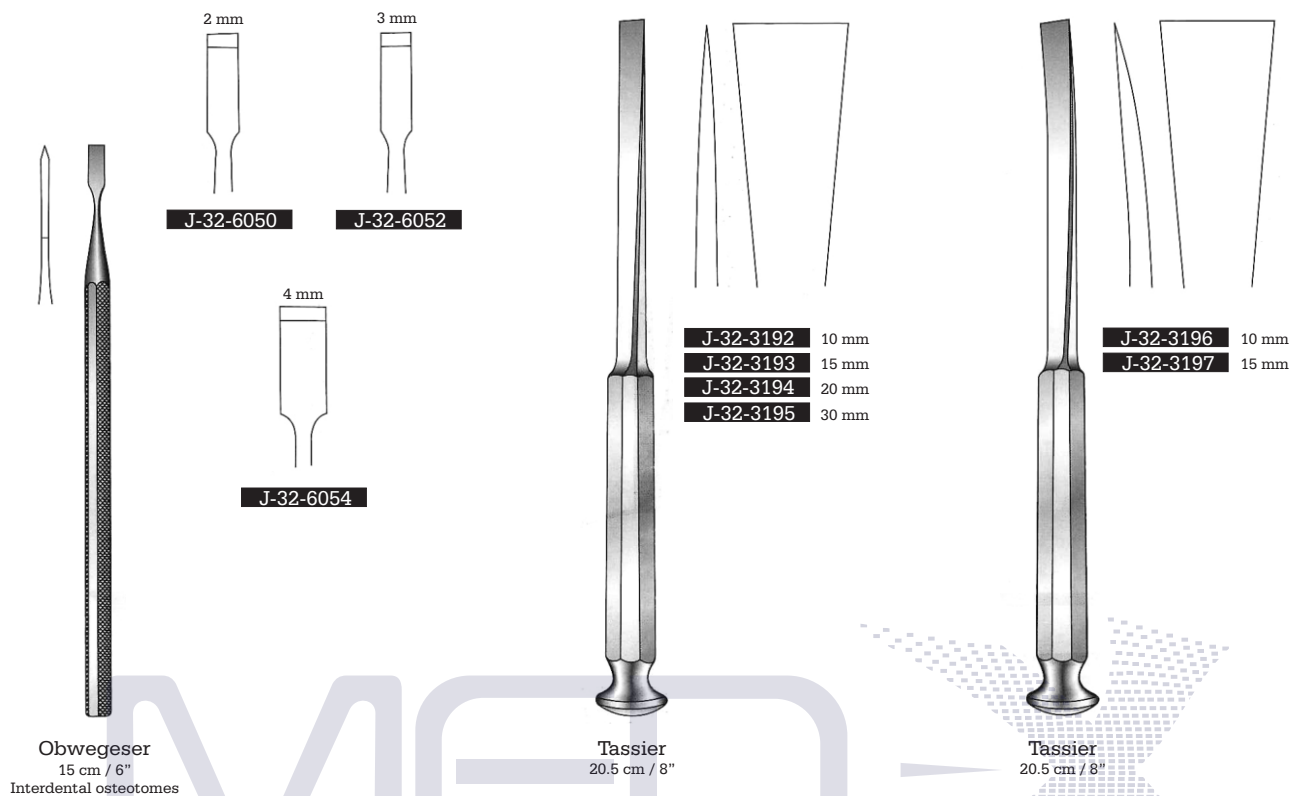



Tessier
 20 cm / 7¾"
 For Taking Grafts
 From Ilium and Tibia

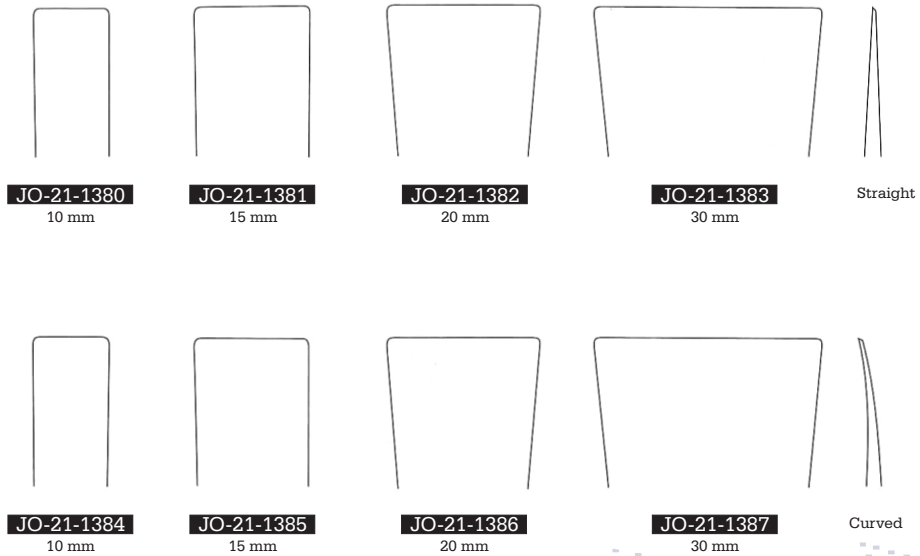

MED 
 SURGICAL DISTRIBUTION

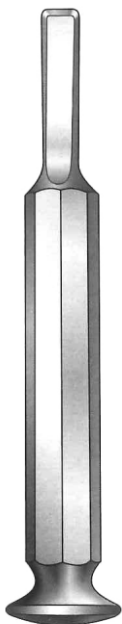

Tessier
 16 cm / 6¼"
 For Taking
 Grafts from the Calva

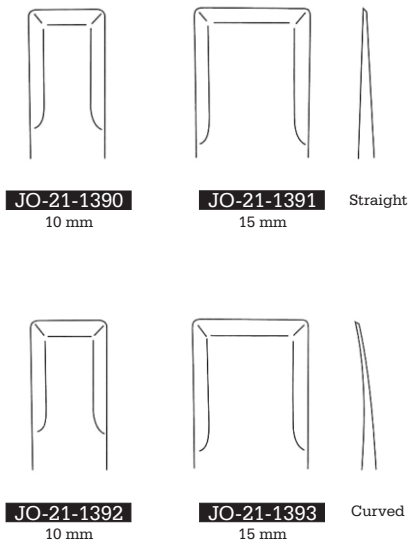

Tessier
 16 cm / 6¼"

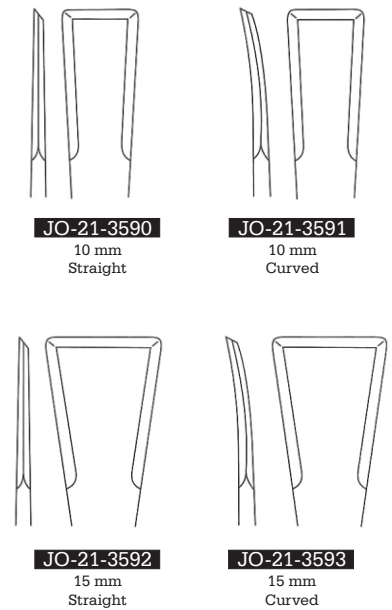

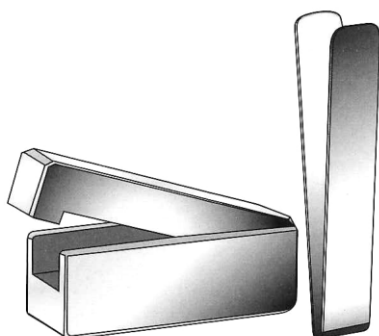

Cottle
J-32-3200
65 x 30 x 30 mm
Cartilage Crushers

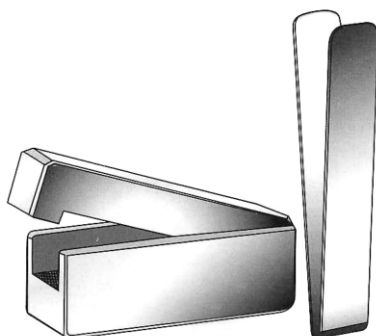

Cottle
J-32-3203
65 x 30 x 30 mm
Cartilage Crushers
With Serration

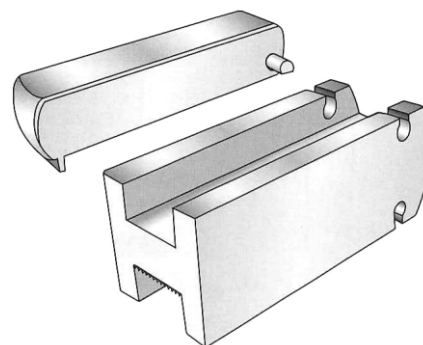

J-32-3212
Serration Straight / Smooth
J-32-3213
Serration Straight / Diamond Dust
J-32-3214
Diamond Dust / Smooth

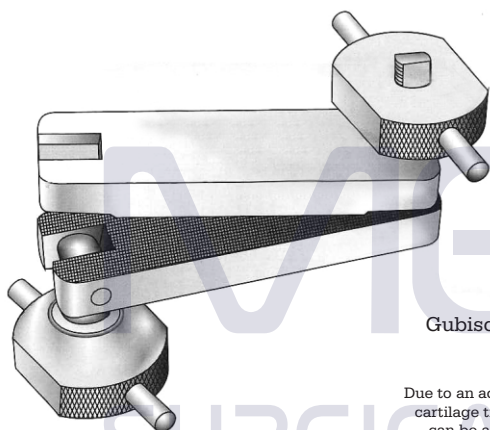

Gubisch Cartilage Crusher
J-32-3201
65 x 30 mm

Due to an adapted pressure a flat, flexible cartilage transplant is obtained, which can be applied in various manners.

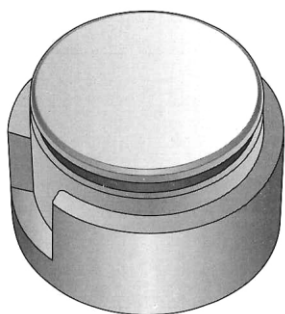

J-32-3202
Serration Model
Round Type

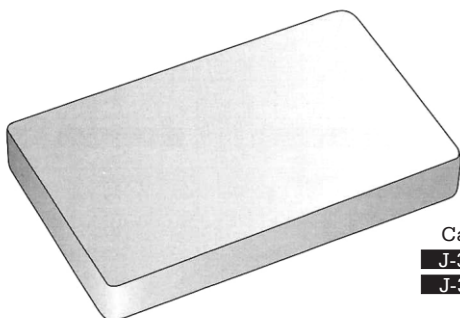

Cartilage Cutting Block
J-32-3235 Stainless Steel
J-32-3237 Made of Teflon
85 x 55 x 10 mm

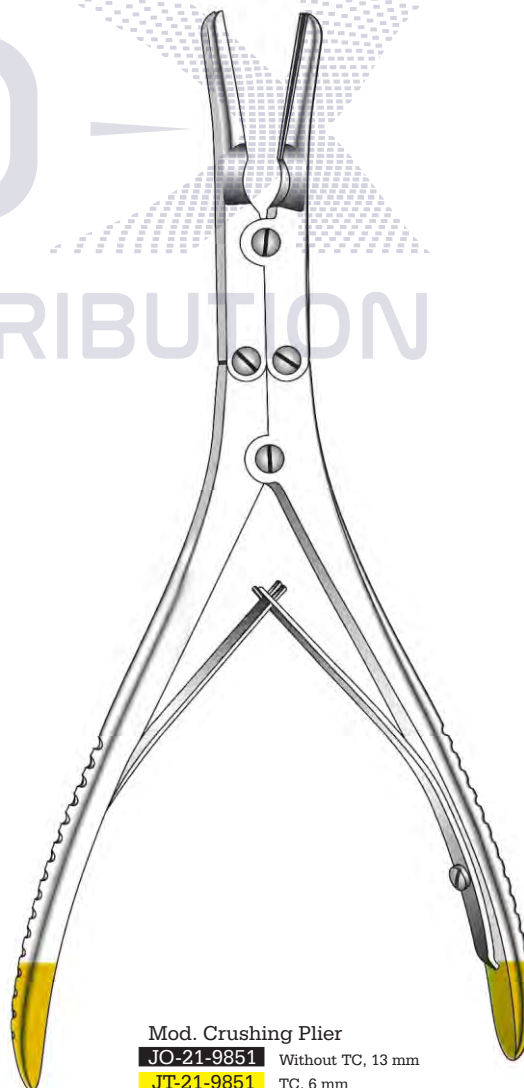

Mod. Crushing Plier
JO-21-9851 Without TC, 13 mm
JT-21-9851 TC, 6 mm
18.5 cm / 7 1/4"

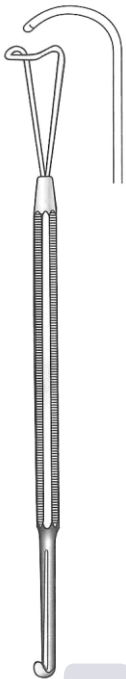

Neivert
J-32-1597
 16 cm / 6 1/4"



Cottle
J-32-1598
 15 cm / 6"
 Saddle hook

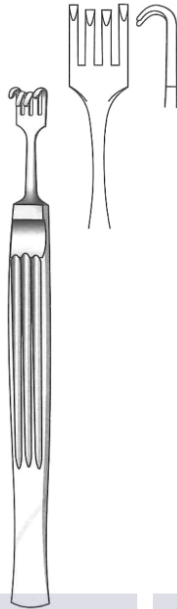

Cottle
J-32-1596
 14 cm / 5 1/2"
 Alar Hooklets



Becker
J-32-3400 Small
J-32-3401 Medium
J-32-3402 Large
J-32-3403 X-Large
 12 cm / 4 3/4"
 Plastic surgery, american made
 open retractors

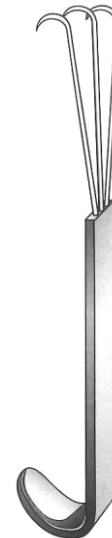

Anderson
 Three prong
J-32-3410
 12 cm / 4 3/4"
 Short
J-32-3412
 16 cm / 6 1/4"
 Long
 Plastic surgery, american
 made retractor

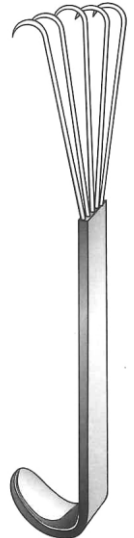

Anderson
 Five prong
J-32-3411
 12 cm / 4 3/4"
 Short
J-32-3413
 16 cm / 6 1/4"
 Long
 Plastic surgery, american
 made retractor



Cottle
J-32-1599
 15 cm / 6"



Aufricht
J-32-1601
 13.5 cm / 5 1/4"
 60 x 6.5 mm blade
 blunt

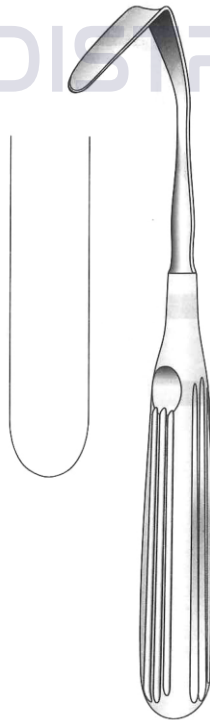

Aufricht
J-33-800 19 cm / 7 1/2"
 40 x 12 mm blade
J-33-801 16 cm / 6 1/4"
 45 x 6 mm blade

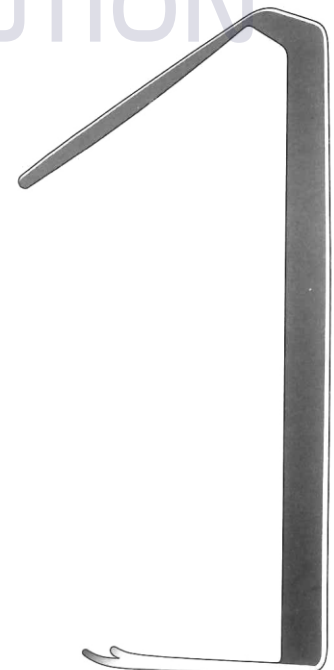

Aufricht
J-33-1390
 11 cm / 4 1/4"
 50 x 6 mm

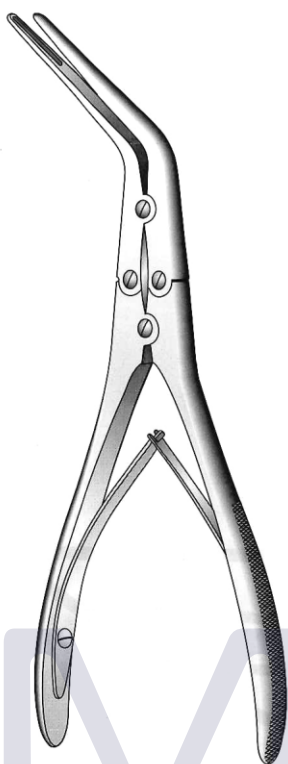

Kressner
J-32-1606
20 cm / 8"

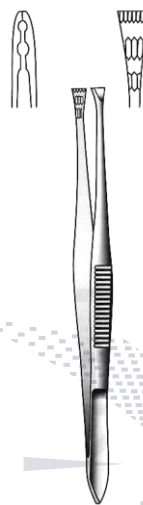

Ogura
J-32-1607
11 cm / 4 1/4"
4 mm wide

MEDIX
SURGICAL DISTRIBUTION

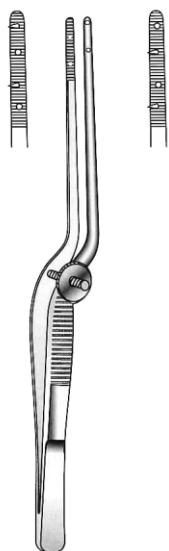

Cottle
J-32-1608
14 cm / 5 1/2"
1.7 mm wide with teeth

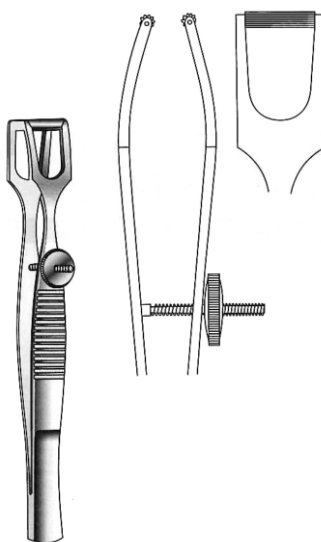

Cottle
J-32-1609
11 cm 4 1/4"
12 mm wide
Columella forceps



Aiach
J-32-1611
15.5 cm / 6"
5 mm wide
Columella suturing forceps



LaRoe Tissue Spreaders

J-32-3420 Straight

J-32-3421 Curved

23 cm / 9"

Small

J-32-3425 Tapered, mod.

J-32-3426 Curved

26 cm / 10¼"

Large

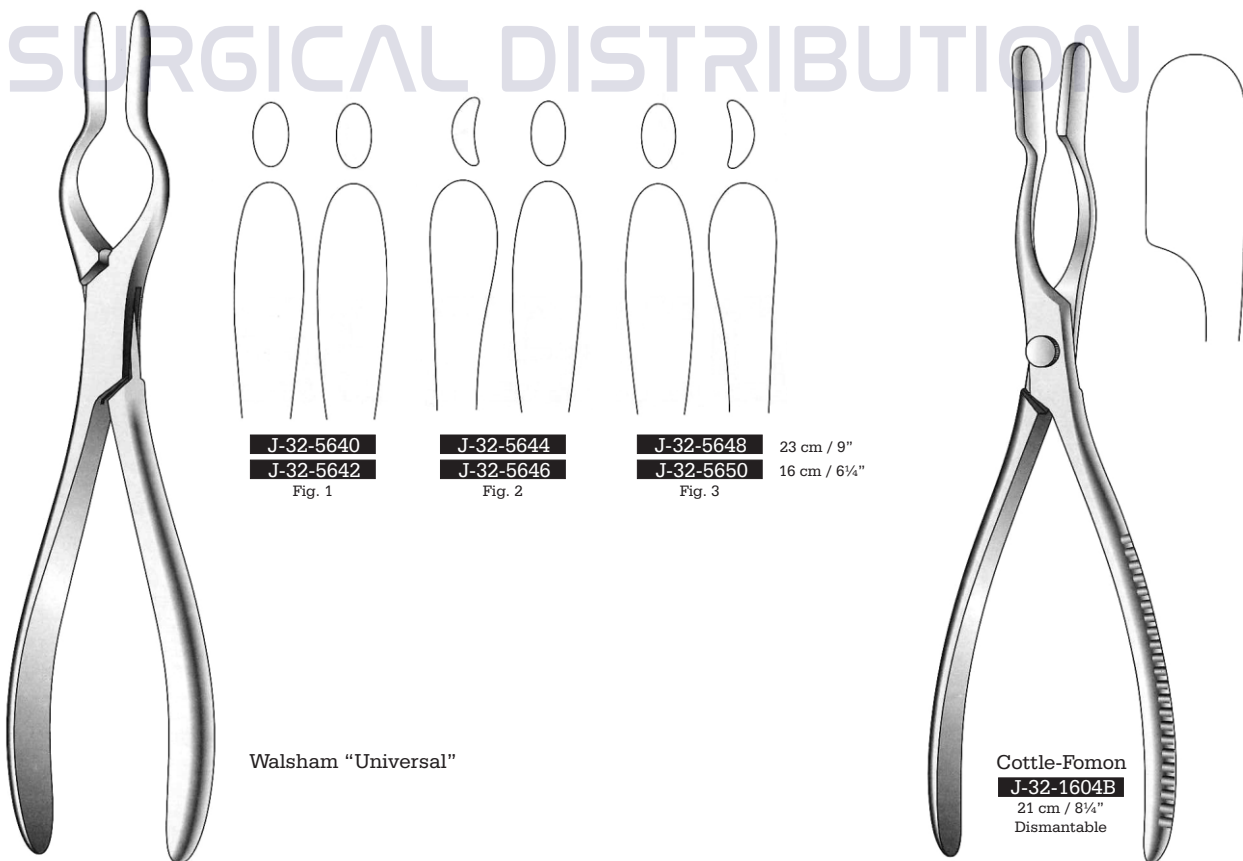
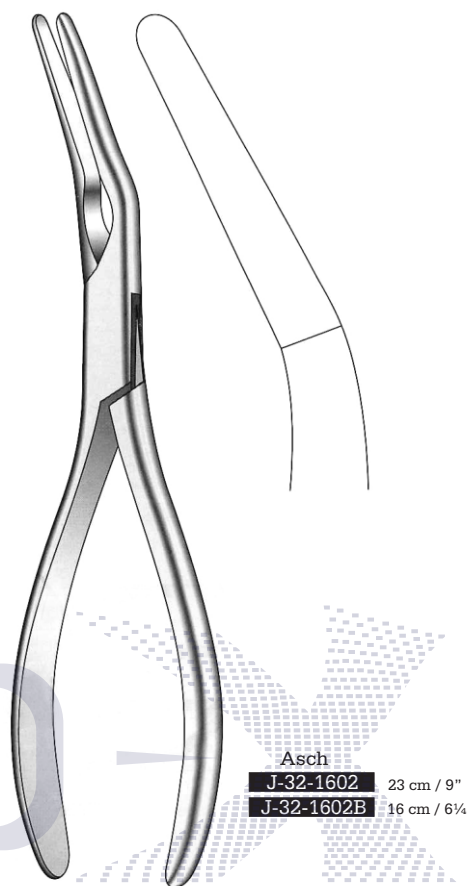
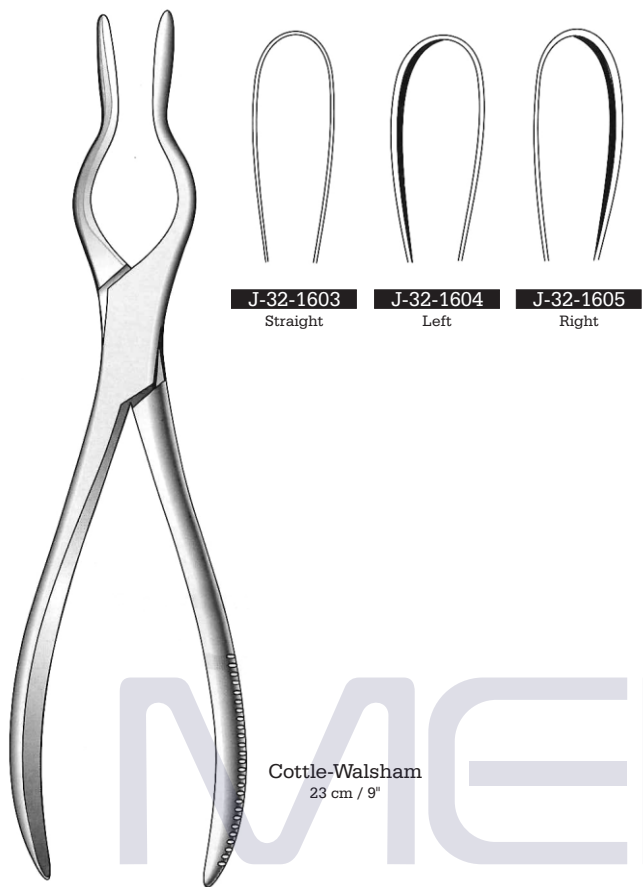

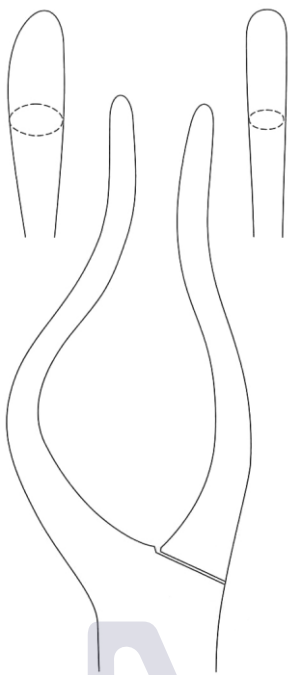

J-32-3210 Left
J-32-3211 Right

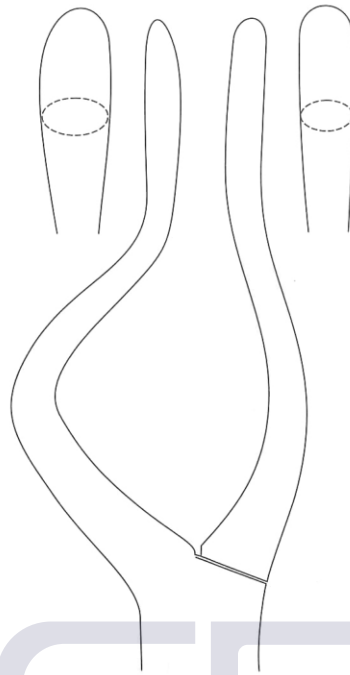

J-32-3220 Left
J-32-3221 Right

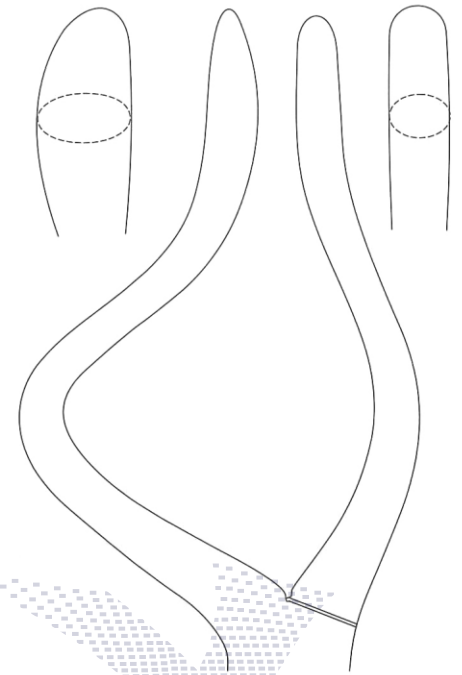

J-32-3230 Left
J-32-3231 Right



Rowe
22.5 cm / 9"
Left



Rowe
24 cm / 9½"
Right

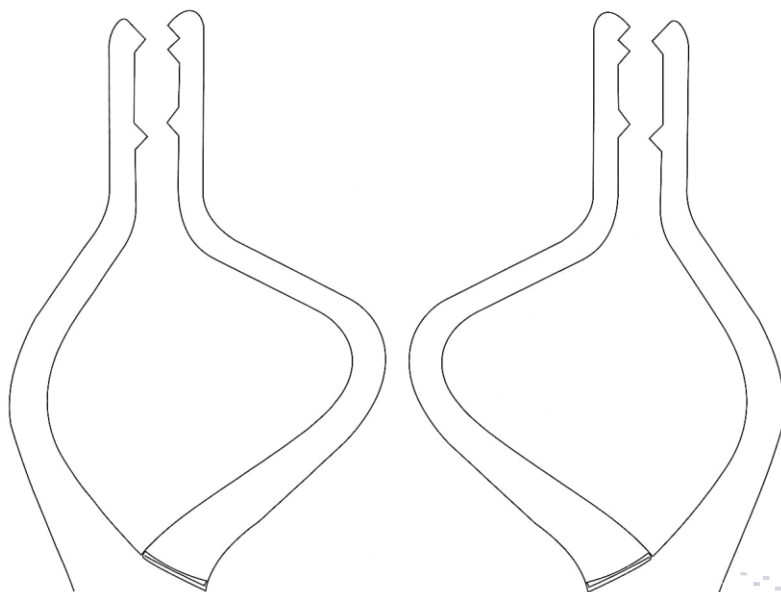

Tessier
J-32-3250
Left
23 cm / 9"
For Adults

Tessier
J-32-3251
Right
23 cm / 9"
For Adults

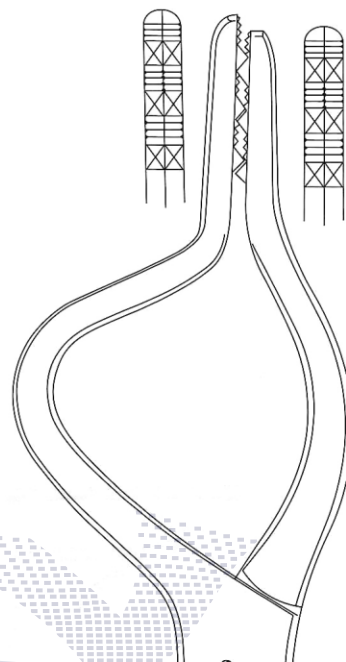

Marchac
J-32-3260
23 cm / 9"
For children

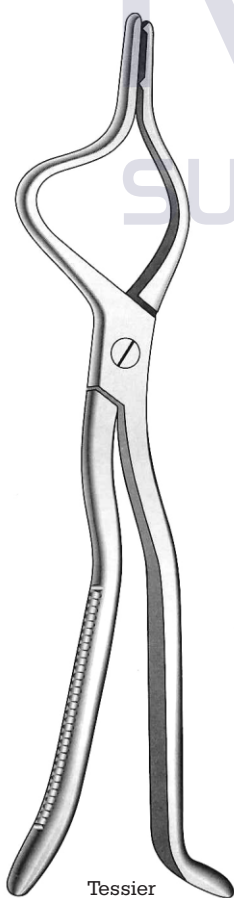

Tessier
23 cm / 9"
For adults

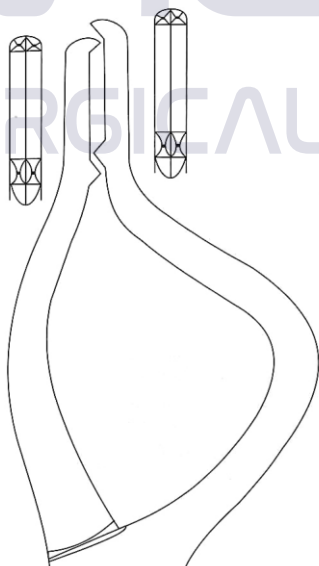

Tessier
J-32-3240
Left
22 cm / 8¾"
For children

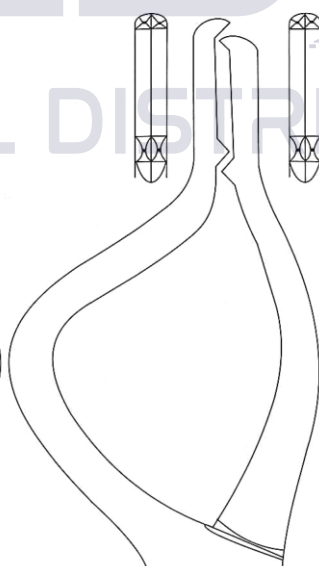

Tessier
J-32-3241
Right
22 cm / 8¾"
For children



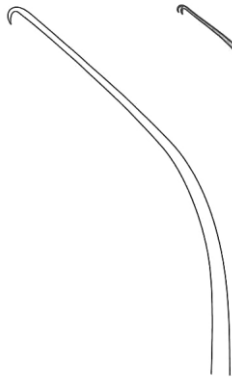

Blocksma
18 cm / 7"
Hooks



J-32-6080

3 mm



J-32-6082

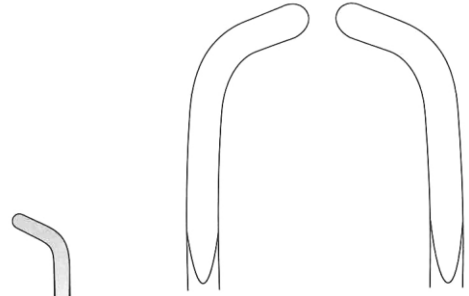

J-32-6090
Left

J-32-6092
Right



Raspatories
14 cm / 5½"

MED 
SURGICAL DISTRIBUTION

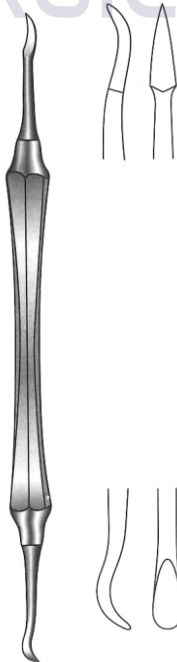

Kahre
J-32-6100
17 cm / 6¾"

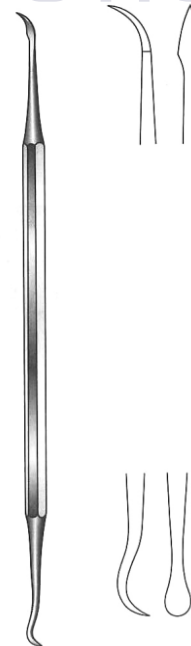

McIndoe
J-32-6105
16.5 cm / 6½"

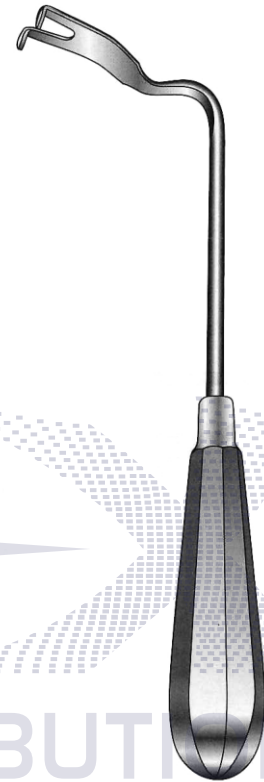
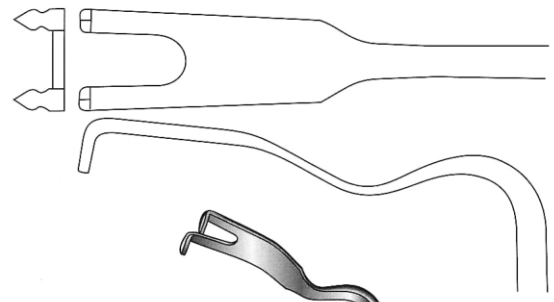
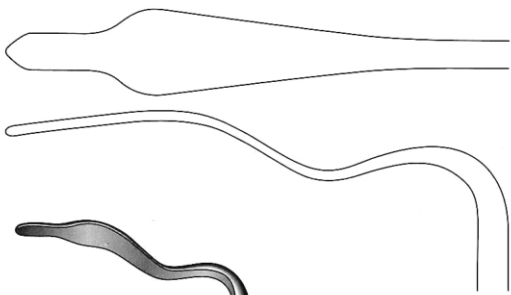

J-32-6110
19 cm / 7½"
Mucoperiosteal retractor

J-32-6120
19 cm / 7½"
Mucoperiosteal retractor

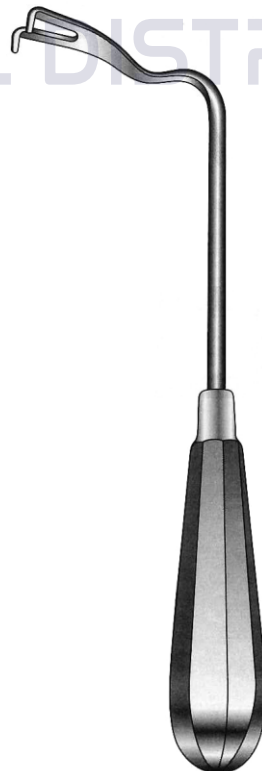

J-32-6130
19 cm / 7½"
Mucoperiosteal retractor

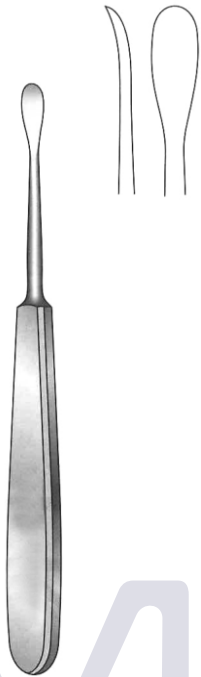

Wang
J-32-6140
15.5 cm / 6 1/8"
Raspatories

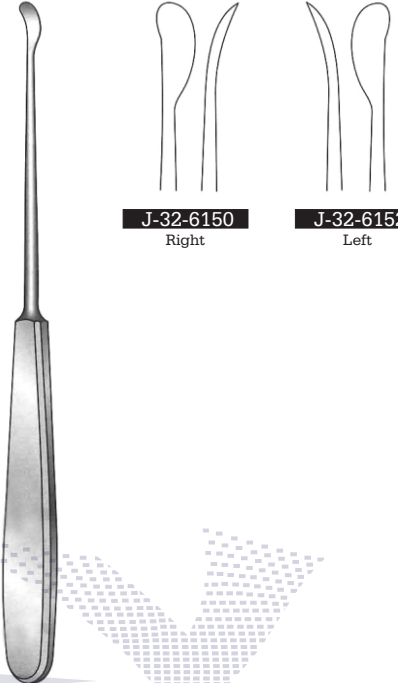

J-32-6150
Right

J-32-6152
Left

Wang
18 cm / 7"
Raspatories

MED 
SURGICAL DISTRIBUTION

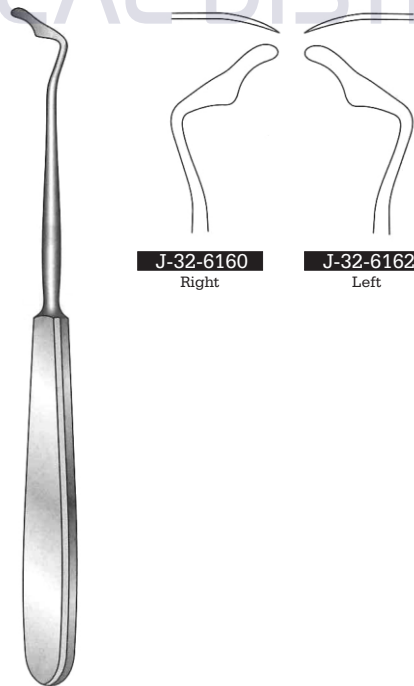

J-32-6160
Right

J-32-6162
Left

Wang
18 cm / 7"
Raspatories

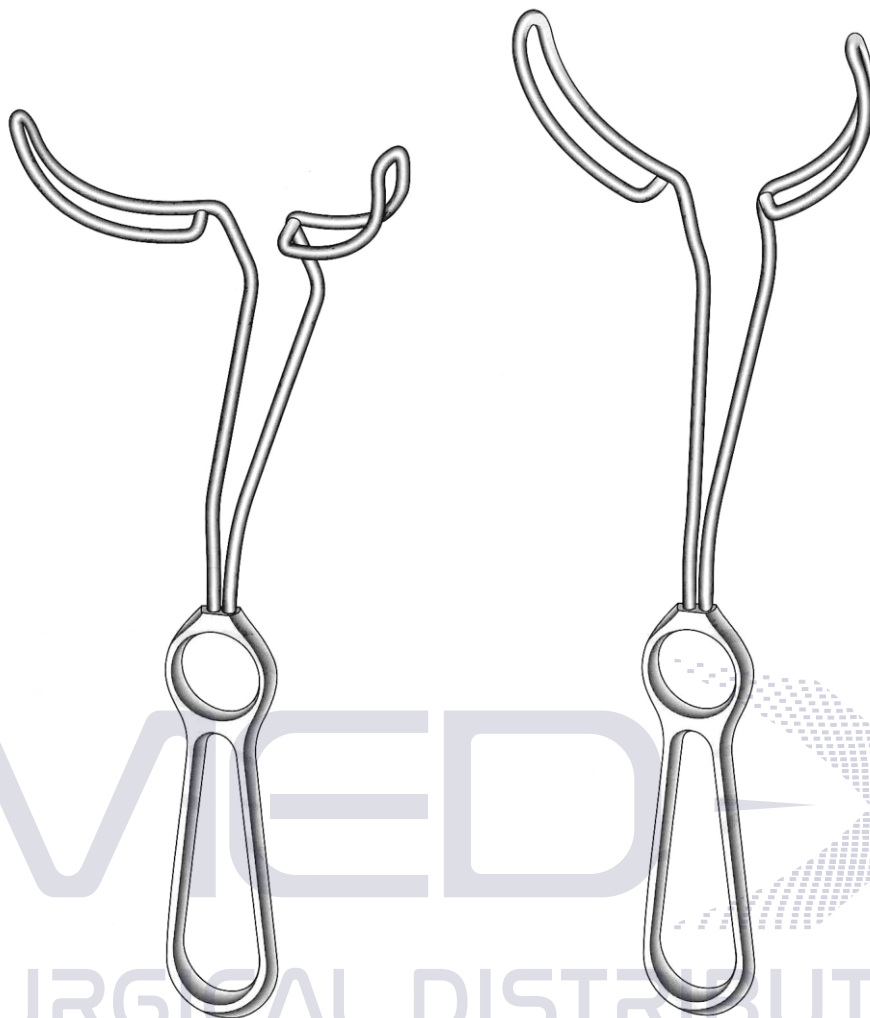

J-33-2010
21 cm / 8¼"
For Upper Jaw

J-33-2005
26 cm / 10¼"
For lower Jaw



J-33-610
14 cm / 5½"
Vestibulum retractor



Crawford Minnesota
J-33-495
15 cm / 6"
20 mm

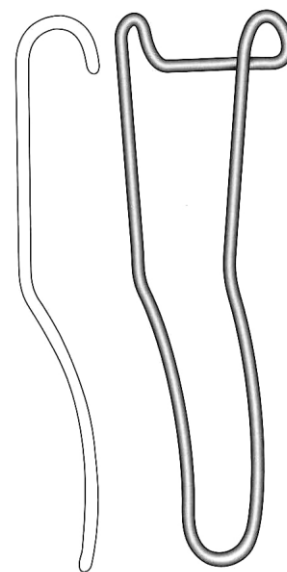

Sternberg
J-33-498
14.5 cm / 5¾"
With tongue depressor

ENT & Plastic Surgery Instruments



Oral Instruments

Oral Instruments

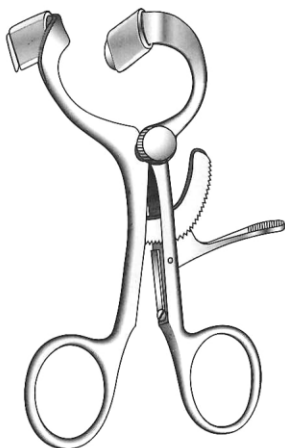

Molt / Doyen
J-33-001
11 cm / 4 1/4"

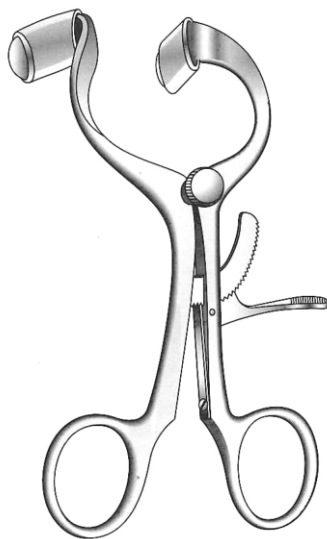

Molt / Doyen
J-33-010
14 cm / 5 1/2"

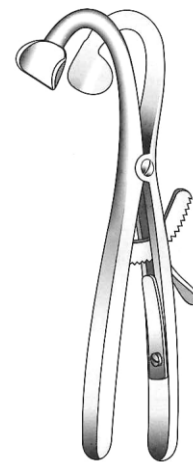

Denhart
J-33-020
12 cm / 4 3/4"
16 mm jaw

MEDICAL
SURGICAL DISTRIBUTION

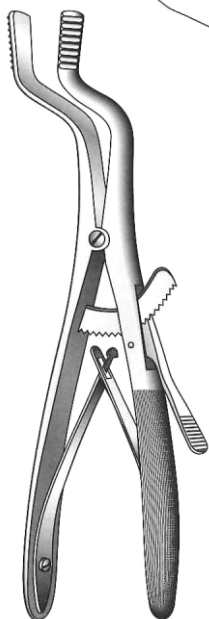

Roser-Konig

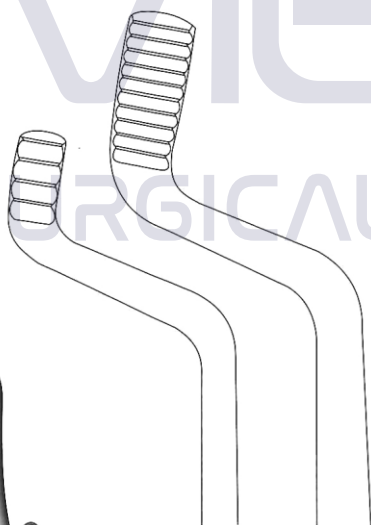

J-33-030
16 cm / 6 1/4"

J-33-040
19 cm / 7 1/2"

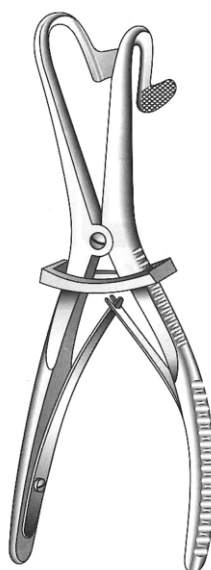

Fergusson

J-33-050 16 cm / 6 1/4"
J-33-060 19 cm / 7 1/2"
Ackland jaws

J-33-070
J-33-080
Parallel jaws

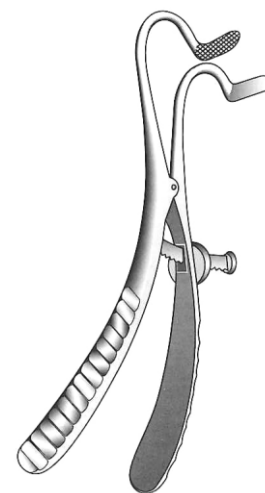

Mason

J-33-090 16 cm / 6 1/4"
J-33-100 19 cm / 7 1/2"
Ackland jaws

J-33-110
J-33-120
Parallel jaws

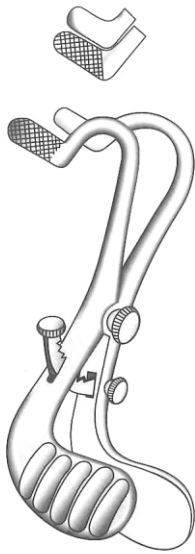

Buxton

J-33-130

Ackland jaws

J-33-140

Parallel jaws

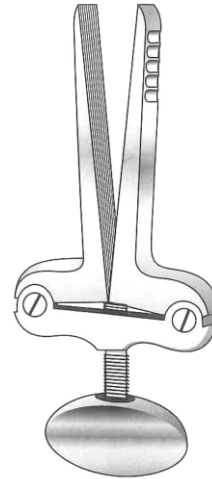

Heister

J-33-150

-13 cm / 5"

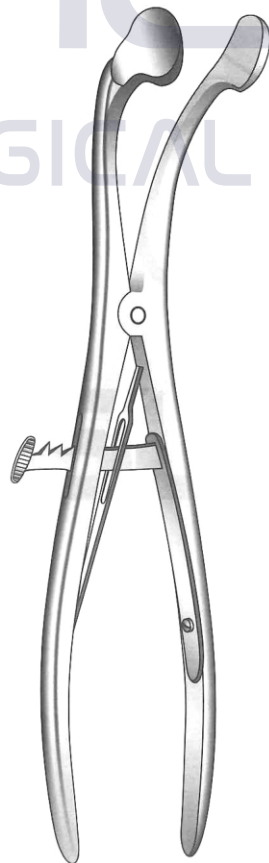

Delabarre

J-33-045

20 cm / 8"

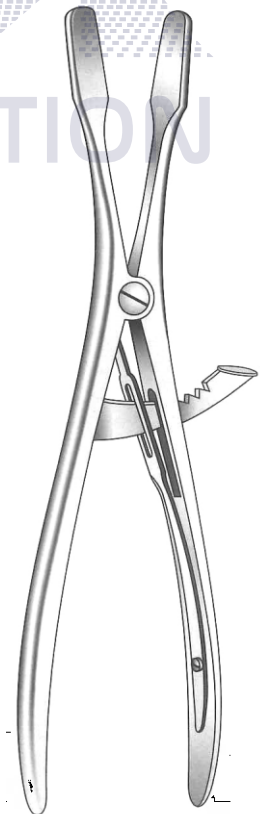

Terrier

J-33-041

Straight

J-33-042

Curved

20 cm / 8"



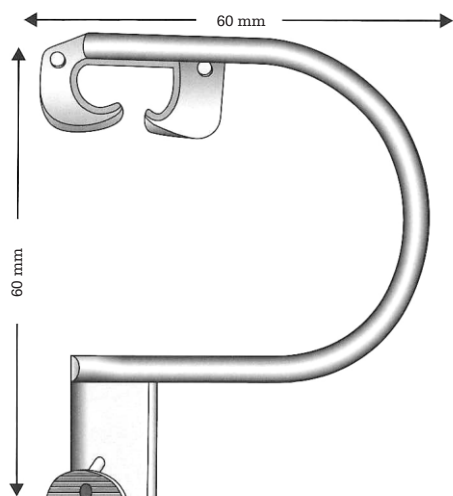

J-33-159
Frame only

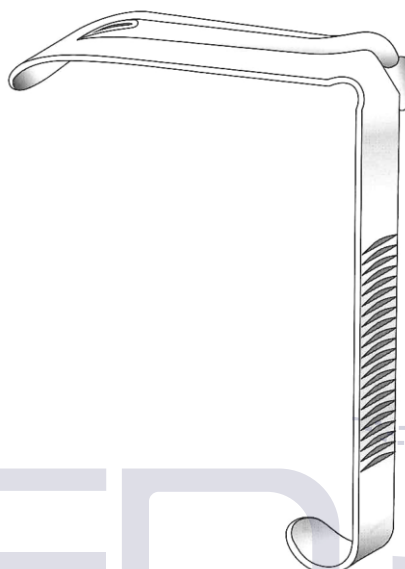

Davis Boyle
J-33-181
Complete set with frame & 5 blades

J-33-160
27 x 105 mm

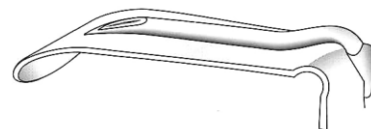

J-33-170
25 x 90 mm

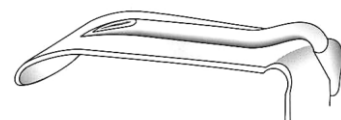

J-33-180
25 x 75 mm

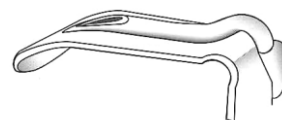

J-33-190
22 x 60 mm

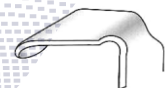

J-33-191
20 x 25 mm

SURGICAL DISTRIBUTION

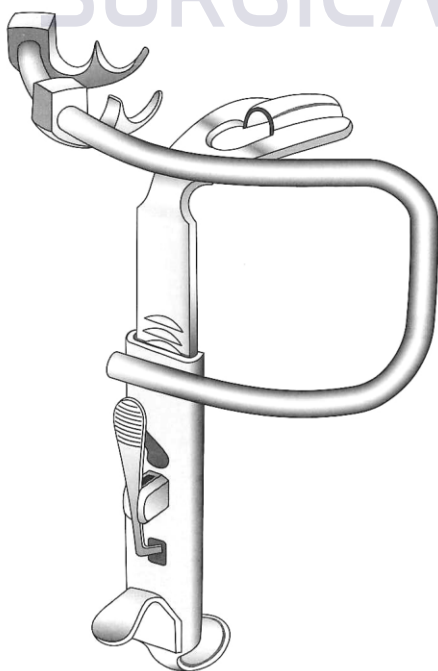

Kilner Doughty
J-33-185
Complete with frame, 3 tongue depressors,
2 tooth plates and 1 palate plate

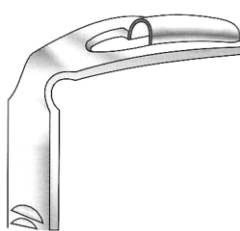

J-33-186
13.5 cm / 5 1/4"
70 x 29 mm

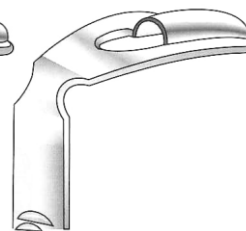

J-33-187
13.5 cm / 5 1/4"
80 x 34 mm

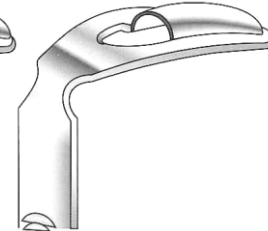

J-33-188
13.5 cm / 5 1/4"
85 x 38 mm



J-33-189
14.5 cm / 5 3/4"
Frame only for mouth gag

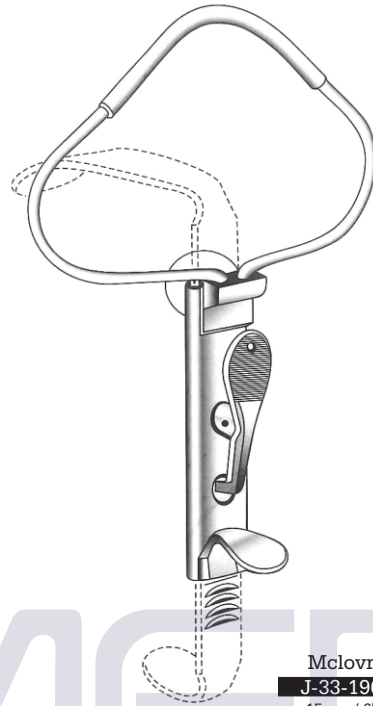

Mclovr
J-33-196
15 cm / 6"
65 x 100 mm
Frame for mouth gag

J-33-195
Complete with frame
and 3 tongue blades

MED 
SURGICAL DISTRIBUTION

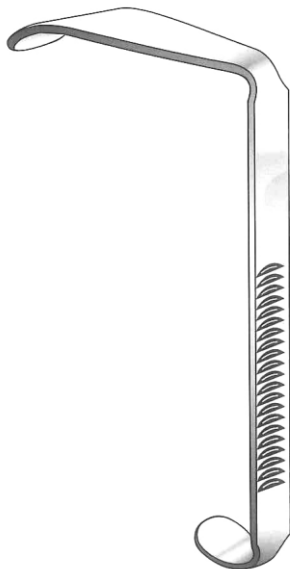

Mclovr
J-33-197
13.5 cm / 5¼"
100 x 26 mm
Tongue depressor

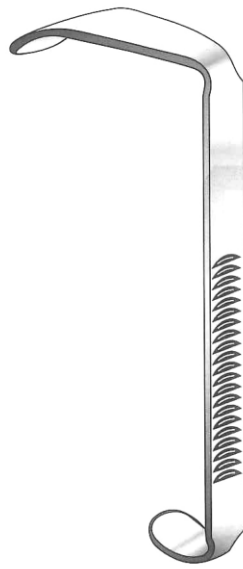

Mclovr
J-33-198
13.5 cm / 5¼"
85 x 25 mm
Tongue depressor

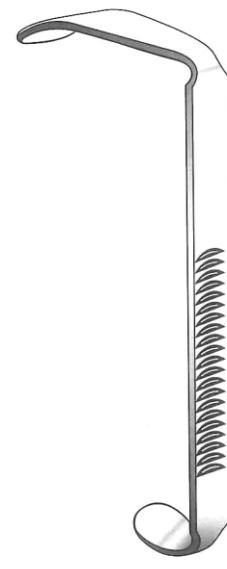

Mclovr
J-33-199
13.5 cm / 5¼"
75 x 23 mm
Tongue depressor

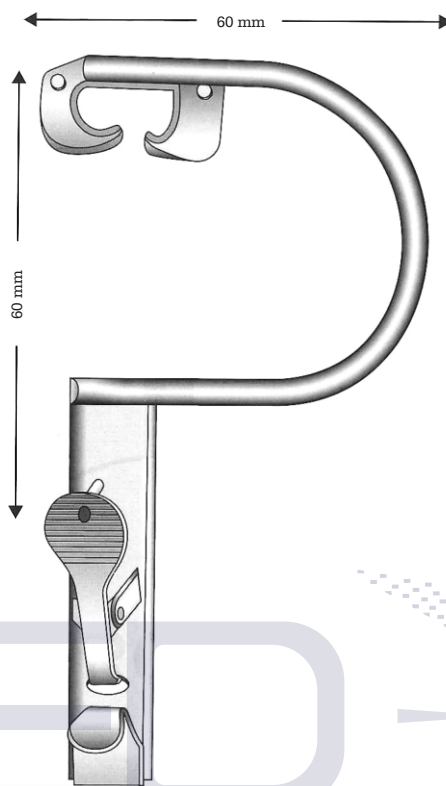

J-33-159S
Baby Frame only

J-33-181S
Speavis Boyle Complete Set
with Baby Frame and
3 Blades

MEDIX
SURGICAL DISTRIBUTION

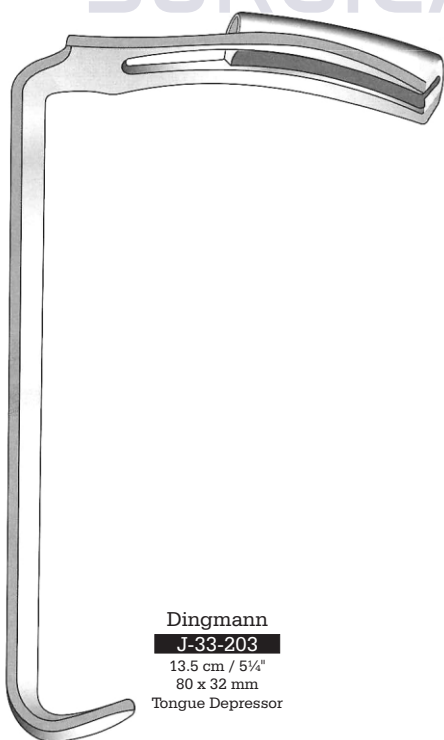

Dingmann
J-33-203
13.5 cm / 5¼"
80 x 32 mm
Tongue Depressor

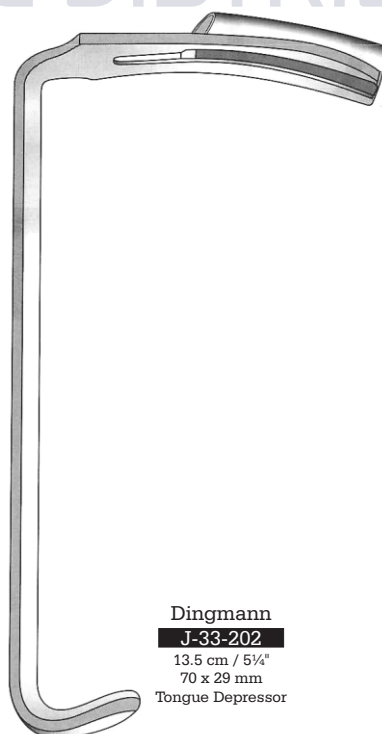

Dingmann
J-33-202
13.5 cm / 5¼"
70 x 29 mm
Tongue Depressor

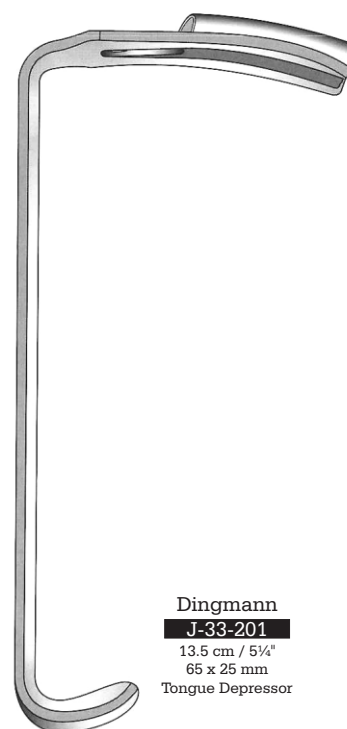

Dingmann
J-33-201
13.5 cm / 5¼"
65 x 25 mm
Tongue Depressor

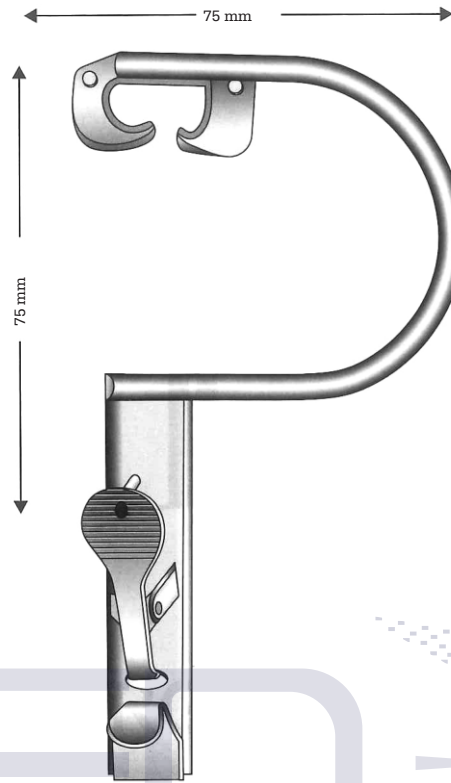

J-33-159
 Frame Only

J-33-1851
 Special Kilner Doughty
 Complete Set With 3 Blades



J-33-188
 Length 13.5 cm
 85 mm x 38 mm



J-33-187
 Length 13.5 cm
 80 mm x 34 mm

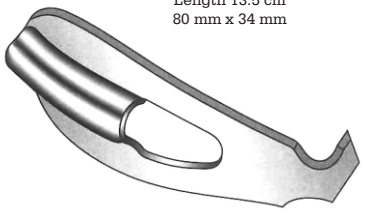

J-33-186
 Length 13.5 cm
 70 mm x 29 mm

Total Length 13.5 cm / 5 1/4"

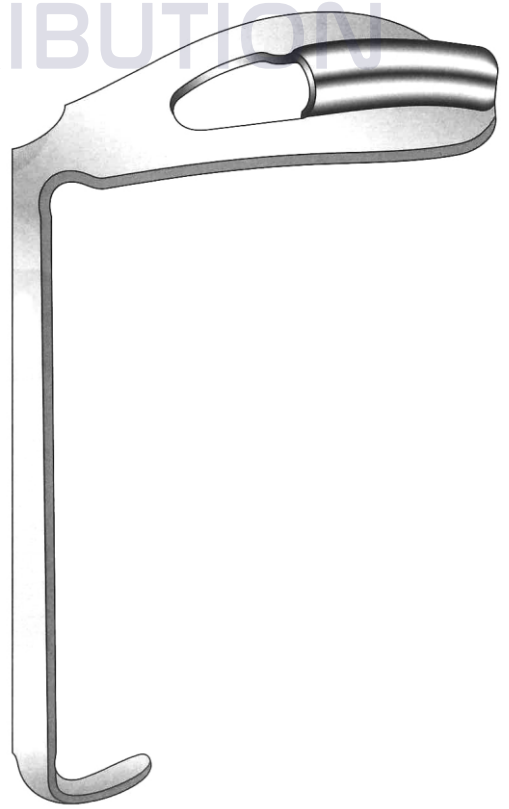

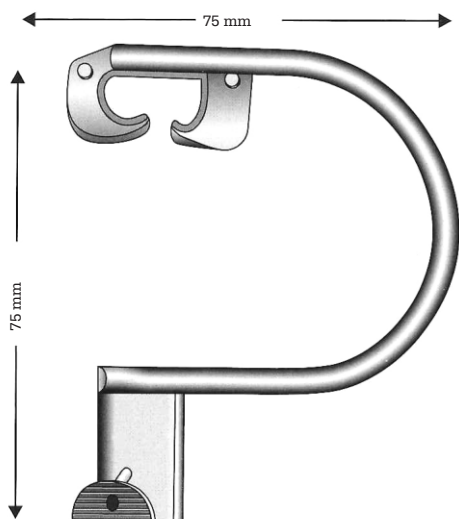

J-33-159
Frame Only

J-33-1810
Special Davis Boyle
Complete Set with Frame and
5 without Tube Blades

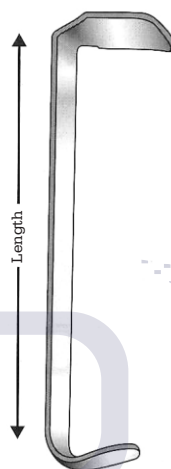

J-33-1910
Length 13.5 cm
20 mm x 25 mm
No Secretion

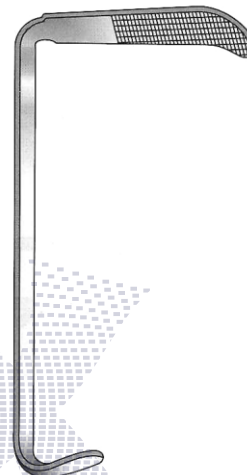

J-33-1900
Length 13.5 cm
22 mm x 60 mm

SURGICAL DISTRIBUTION

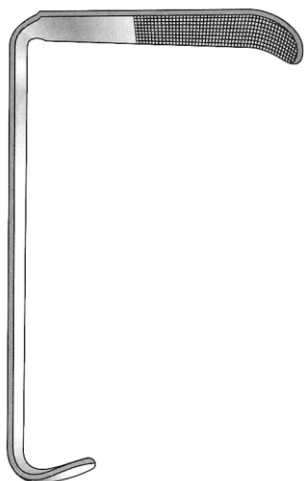

J-33-1800
Length 13.5 cm
25 mm x 75 mm

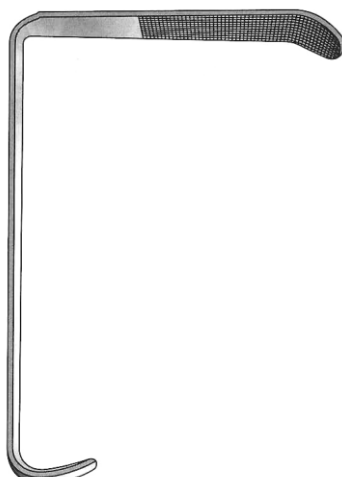

J-33-1700
Length 13.5 cm
25 mm x 90 mm

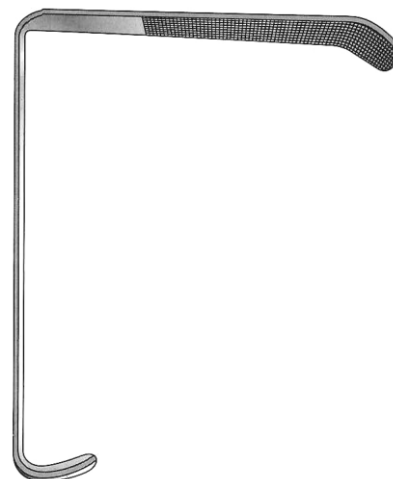

J-33-1600
Length 13.5 cm
27 mm x 105 mm

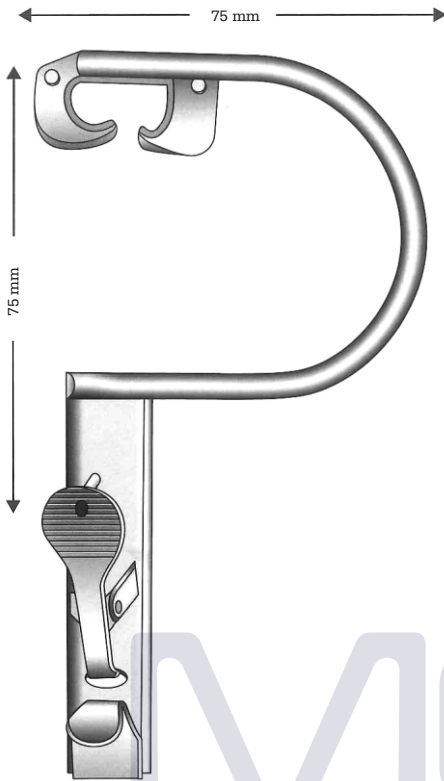

J-33-159S
 Baby Frame Only

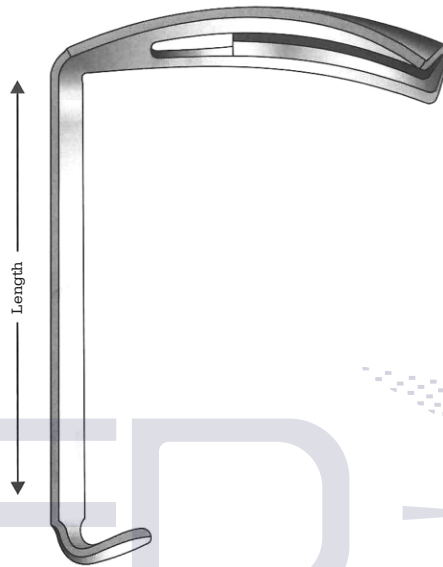

J-33-1850
 Special Kilner Dougherty
 Complete Set with 5 Blades

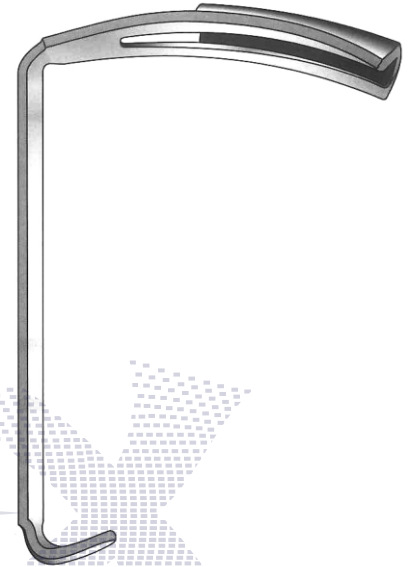

J-33-1880
 Length 13.5 cm
 90 mm x 40 mm

J-33-1881
 Length 13.5 cm
 100 mm x 46 mm

SURGICAL DISTRIBUTION

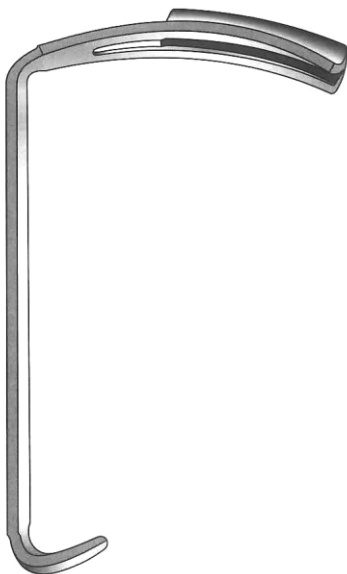

J-33-188
 Length 13.5 cm
 85 mm x 38 mm

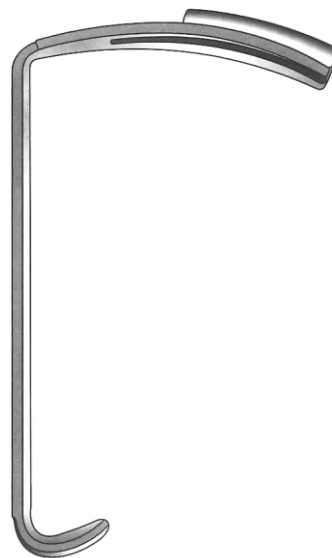

J-33-187
 Length 13.5 cm
 80 mm x 34 mm

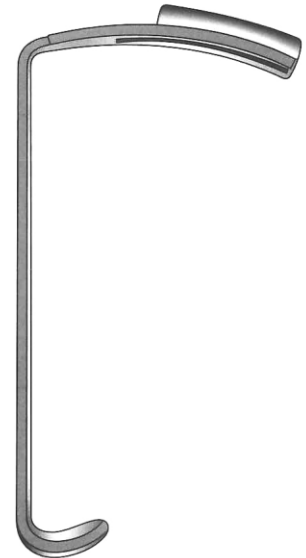

J-33-186
 Length 13.5 cm
 70 mm x 29 mm

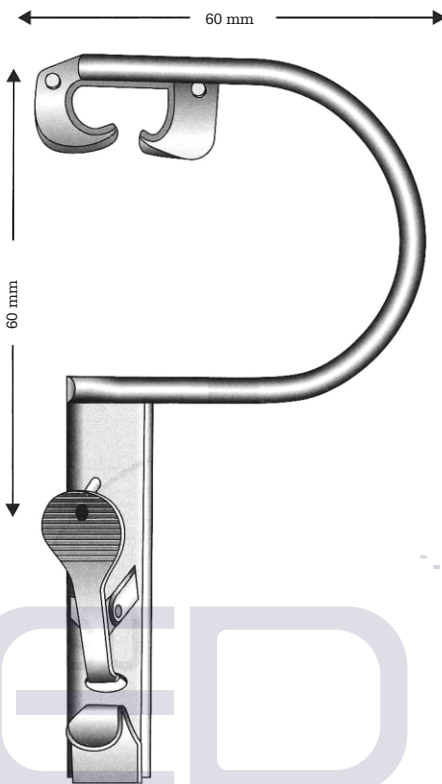

J-33-159S
Baby Frame Only

J-33-181S

Speavis Boyle
Complete Set with Baby Frame
and 3 Without Tube Blades

MEDEX
SURGICAL DISTRIBUTION

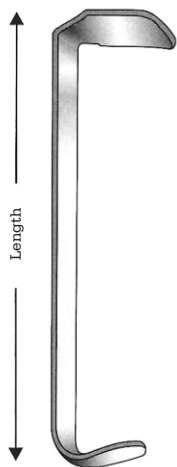

J-33-1910
Length 13.5 cm
20 mm x 25 mm
without Secretion

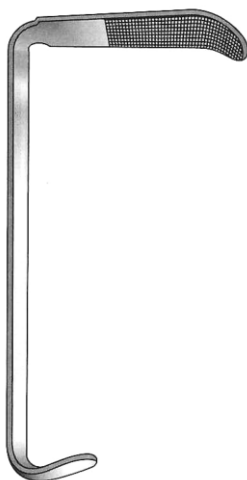

J-33-1900
Length 13.5 cm
22 mm x 60 mm

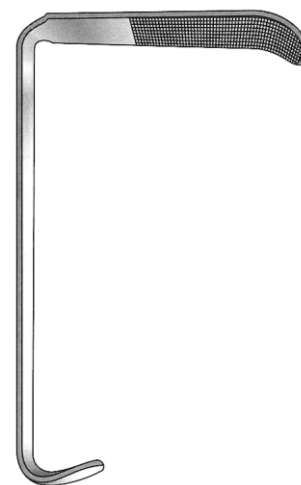

J-33-1800
Length 13.5 cm
25 mm x 75 mm

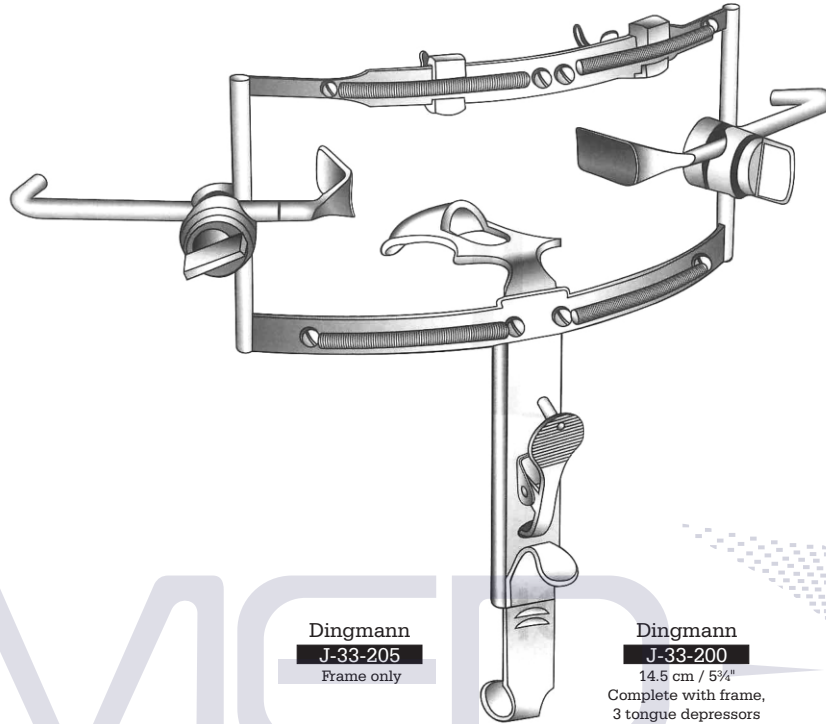

Dingmann
J-33-205
Frame only

Dingmann
J-33-200
14.5 cm / 5 7/8"
Complete with frame,
3 tongue depressors
and 2 adjustable lateral blades

MED 
SURGICAL DISTRIBUTION

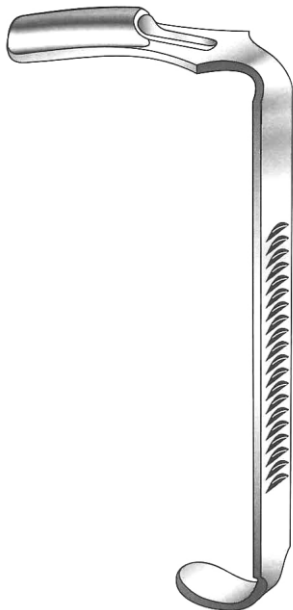

Dingmann
J-33-201
13.5 cm / 5 1/4"
65 x 25 mm
Tongue depressor

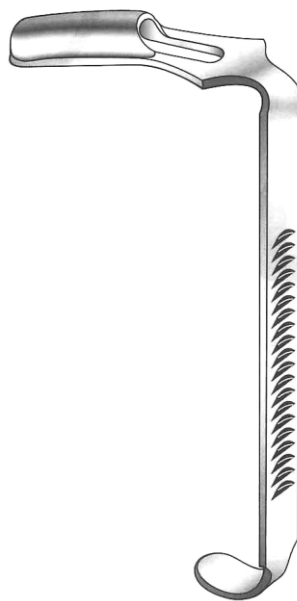

Dingmann
J-33-202
13.5 cm / 5 1/4"
70 x 29 mm
Tongue depressor

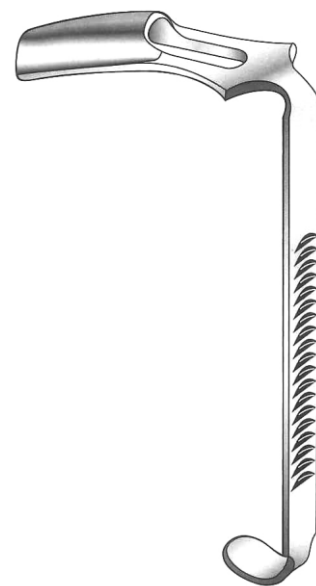

Dingmann
J-33-203
13.5 cm / 5 1/4"
80 x 32 mm
Tongue depressor

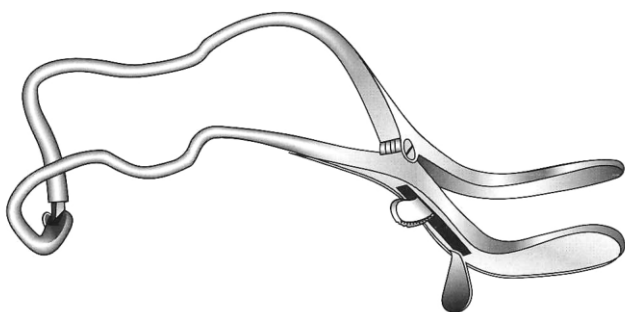

Jenning
J-33-280 9 cm / 3½"
J-33-290 11 cm / 4¼"
J-33-300 13 cm / 5"
J-33-310 15 cm / 6"

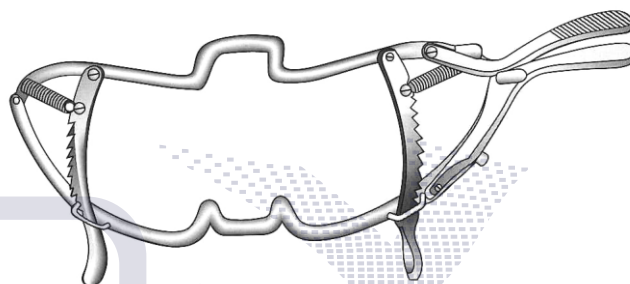

Whitehead
J-33-220 11 cm / 4¼"
J-33-230 13 cm / 5"
J-33-240 15 cm / 6"

MEDIX
SURGICAL DISTRIBUTION

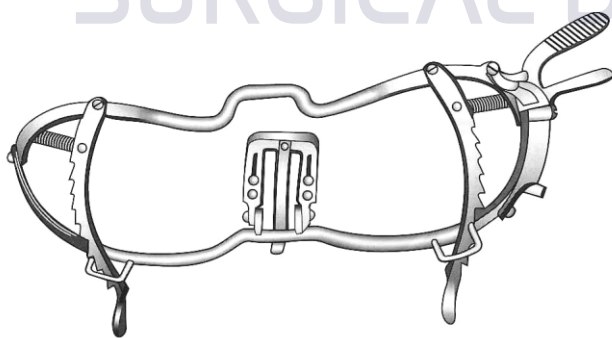

Whitehead
J-33-250 11 cm / 4¼"
J-33-260 13 cm / 5"
J-33-270 15 cm / 6"

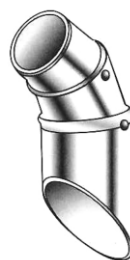

Langenbeck
J-33-320

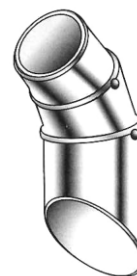

Langenbeck
J-33-330

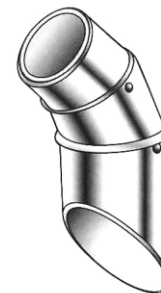

Langenbeck
J-33-340

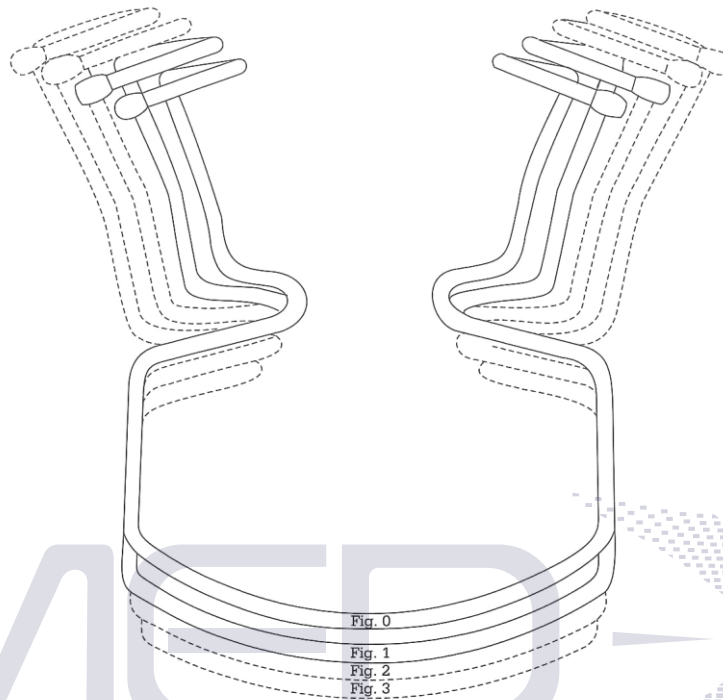

MED 
 SURGICAL DISTRIBUTION

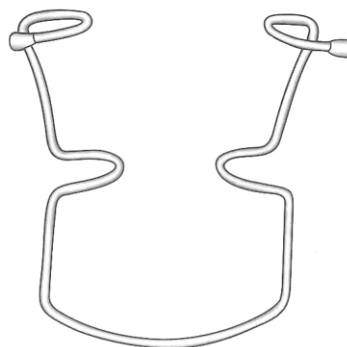

Oringer
 Self retaining

J-33-345	9.5 cm / 3¾"	95 mm, Fig. 0
For children		
J-33-346	10 cm / 4"	110 mm, Fig. 1
J-33-347	10.5 cm / 4"	115 mm, Fig. 2
J-33-348	11 cm / 4¼"	120 mm, Fig. 3
J-33-349	Set of 4, Fig.0 -Fig.3	

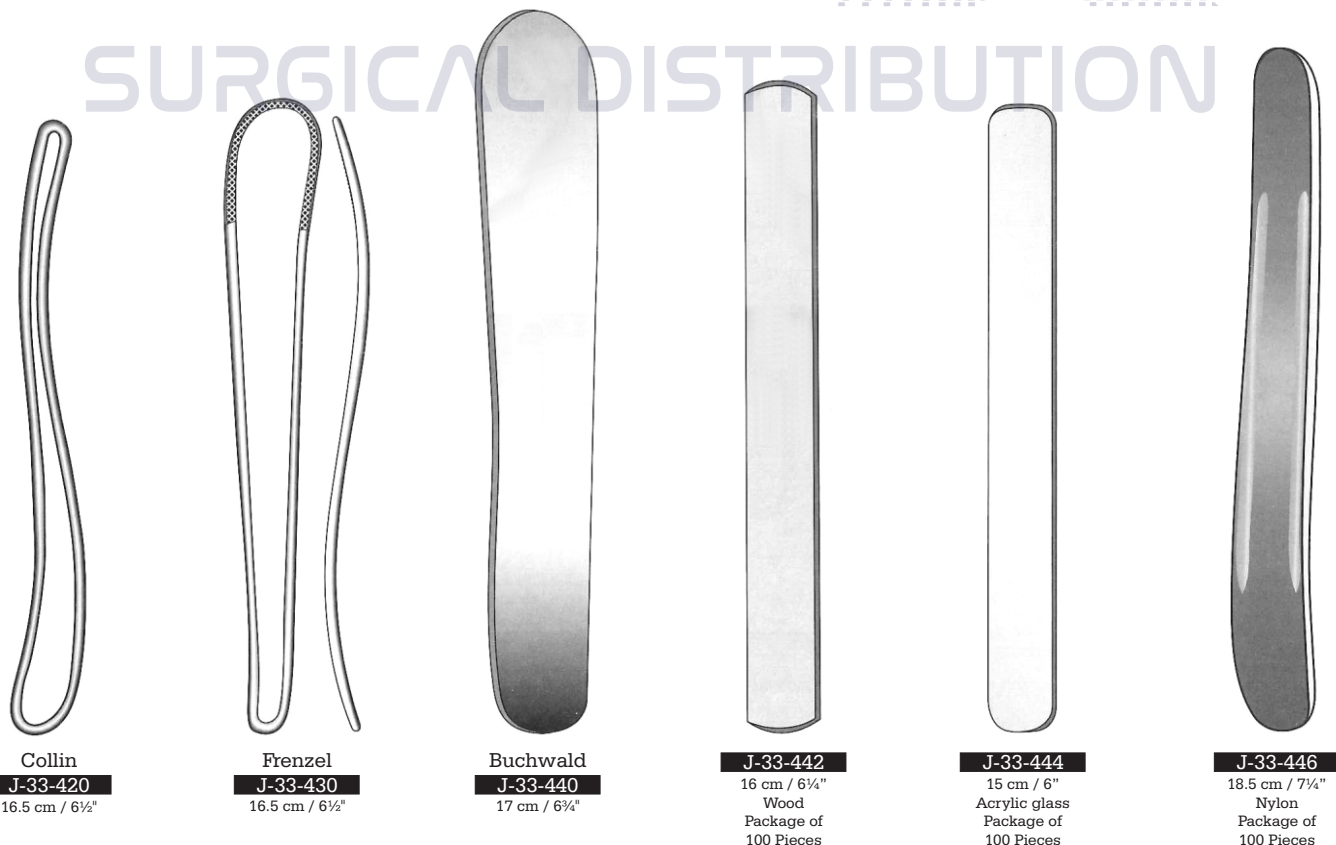

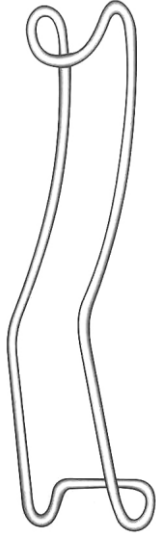

Sternberg

- J-33-491** 12 cm / 4¾"
- J-33-492** 14 cm / 5½"
- J-33-493** 16 cm / 6¼"



Simplex

- J-33-600**
10.5 cm / 4"

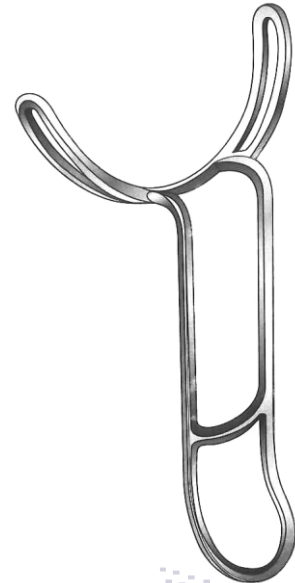

J-33-610

- 14 cm / 5½"
- Vestibulum retractor

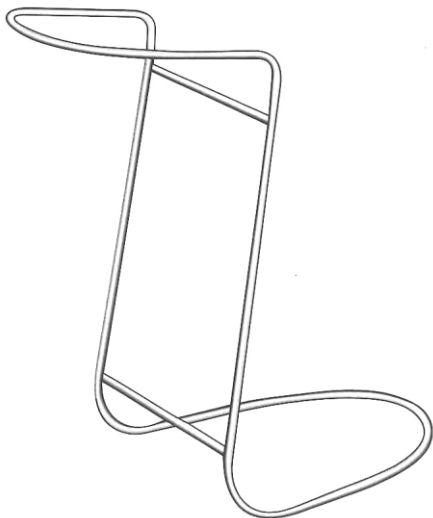
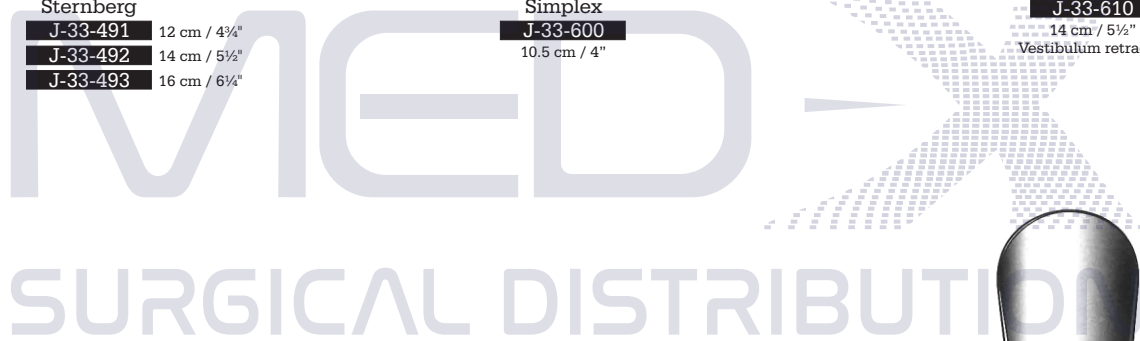

Obwegeser

- J-33-620**
12 cm / 4¾"

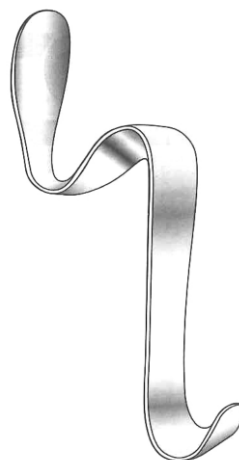

Bishop

- J-33-494**
13.5 cm / 5¼"
27 mm

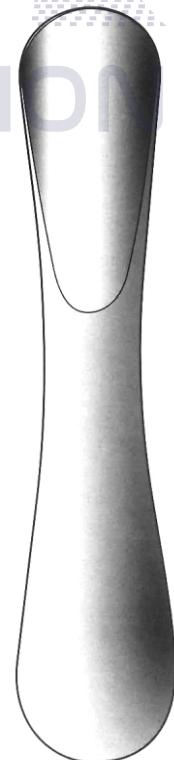

Jaeger

- J-33-1380** Stainless steel
- J-33-1381** Plastic
- 10 cm / 4"
- Lid plate

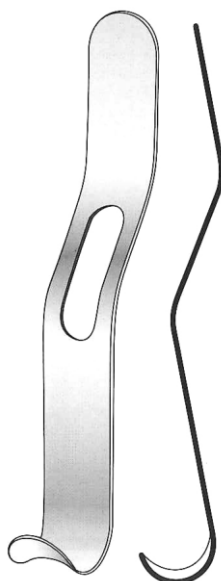

J-33-630
14.5 cm / 5 3/4"
Fenestrated

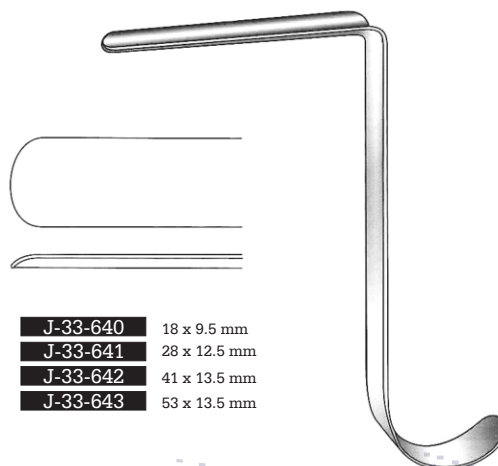

J-33-640	18 x 9.5 mm
J-33-641	28 x 12.5 mm
J-33-642	41 x 13.5 mm
J-33-643	53 x 13.5 mm

Converse
9 cm / 3 1/2"



Lange
J-33-670
23 cm / 9"

Alar hooklet, button end

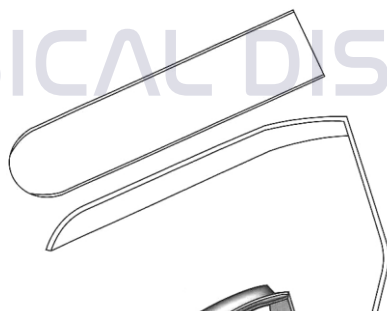

Converse
J-33-650
10.5 cm / 4"

44 x 11 mm blade



J-33-680	1.5 mm Ø
J-33-681	1.7 mm Ø
J-33-682	2.0 mm Ø
J-33-683	2.5 mm Ø
J-33-684	3.0 mm Ø

Siebenmann
15 cm / 6"
Antrum cannula

MEDICAL SURGICAL DISTRIBUTION



Bosworth
J-33-450
14 cm / 5½"

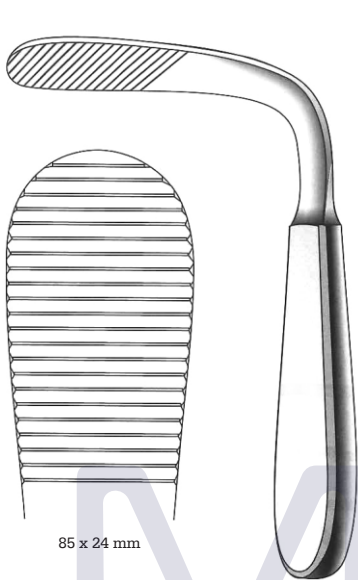

85 x 24 mm

Tobold
J-33-460
14 cm / 5½"

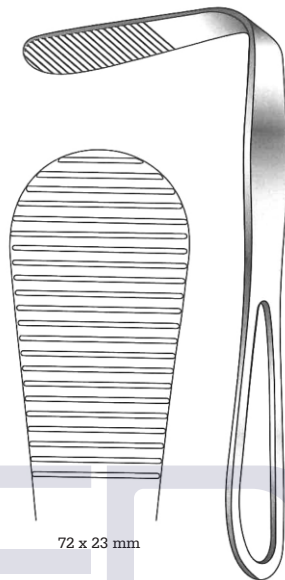

72 x 23 mm

Hartmann
J-33-462
15 cm / 6"

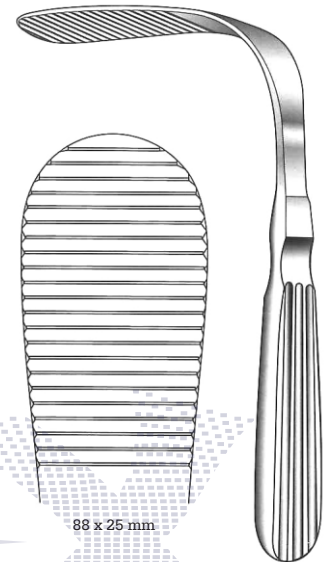

88 x 25 mm

Tobold
J-33-464
15 cm / 6"

SURGICAL DISTRIBUTION

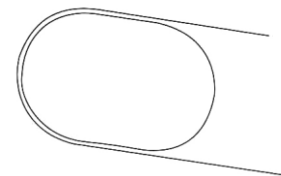

Lack
J-33-490
10 cm / 4"

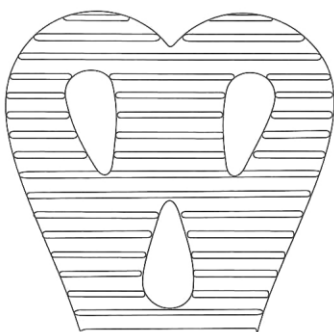

J-33-480
15 cm / 6"
43 mm

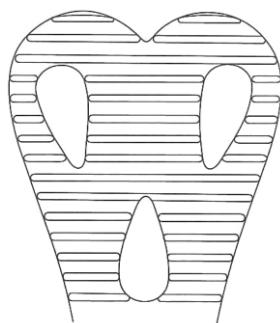

J-33-470
14 cm / 5½"
36 mm

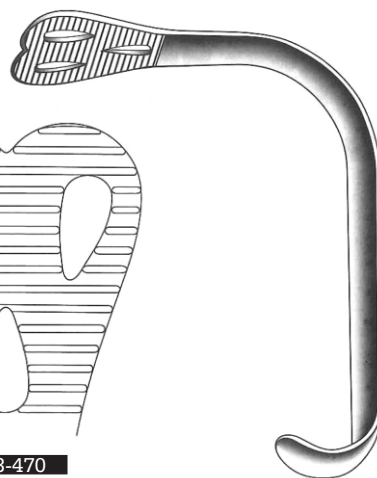

Wieder

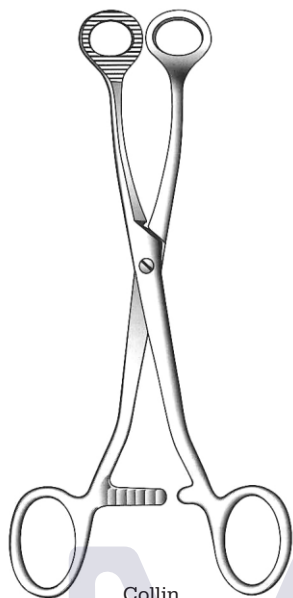

Collin
J-33-500
16 cm / 6¼"

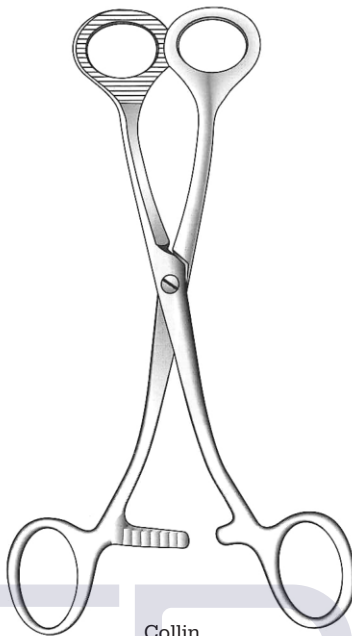

Collin
J-33-509 16 cm / 6¼"
J-33-510 17 cm / 6¾"
J-33-520 19 cm / 7½"

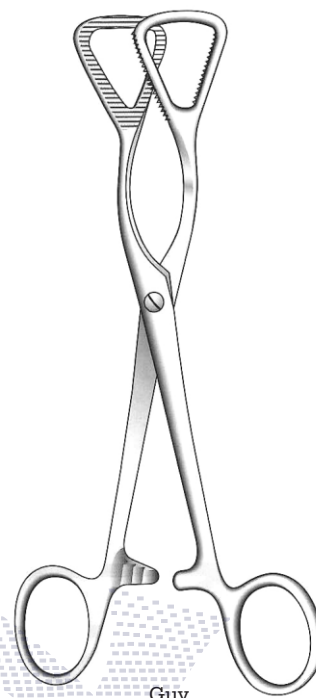

Guy
J-33-530
19 cm / 7½"

MEDIX
SURGICAL DISTRIBUTION

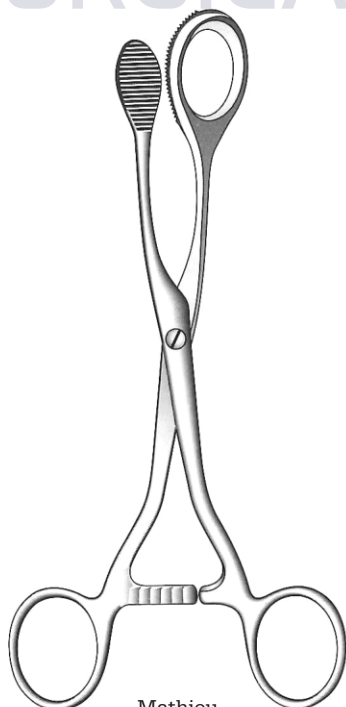

Mathieu
J-33-540
19 cm / 7½"

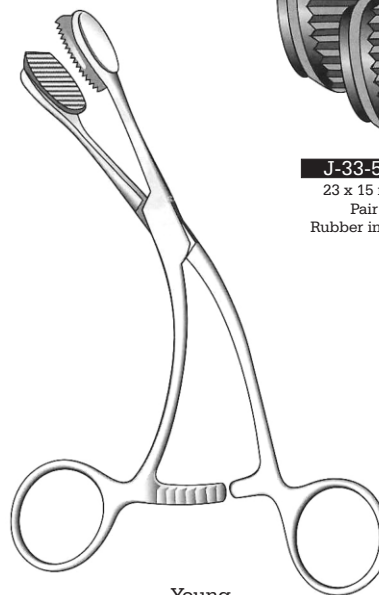

Young
J-33-550
17 cm / 6¾"

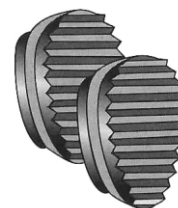

J-33-560
23 x 15 mm
Pair
Rubber inserts

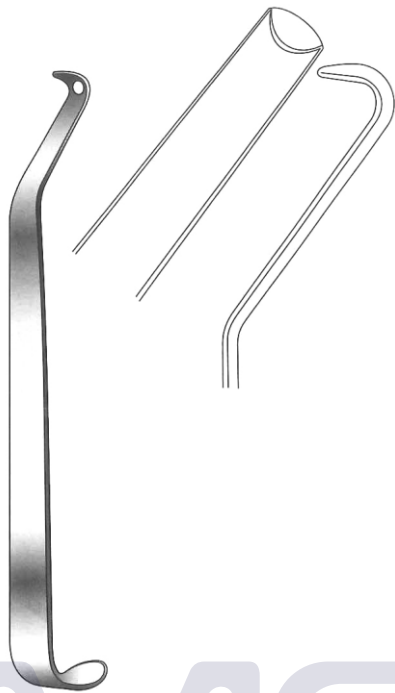

Terry
J-33-810
 16.5 cm / 6½"

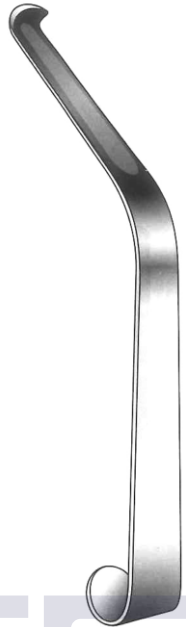

Obwegeser
J-33-820 8 mm
J-33-821 10 mm
 17 cm / 6¾"



Obwegeser
 16.5 cm / 6½"

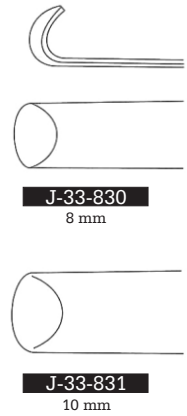

J-33-830
 8 mm

J-33-831
 10 mm

MED SURGICAL DISTRIBUTION

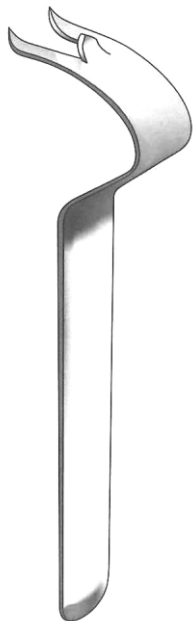

Obwegeser
J-33-840
 16.5 cm / 6½"

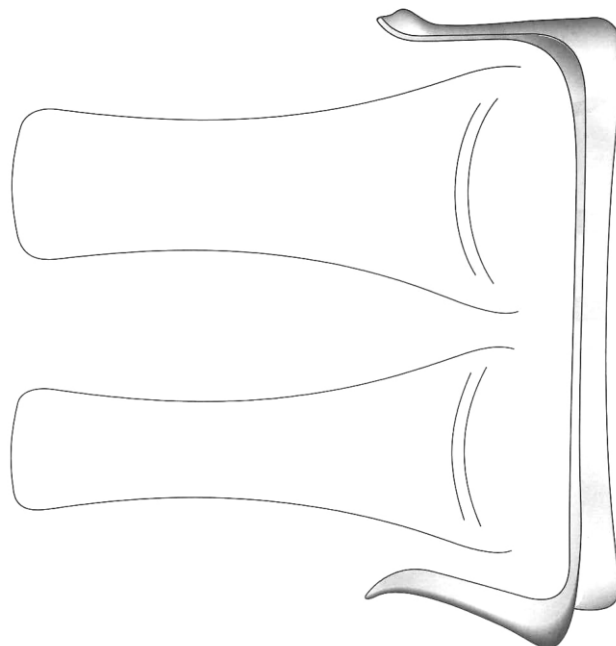

Hargis
J-33-850
 16 cm / 6¼"
 Lip and cheek retractors



Obwegeser
J-33-700
 16 cm / 6¼"
 16.5 mm
 Chin holder

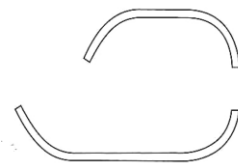

J-33-870
20 x 12; 30 x 16 mm

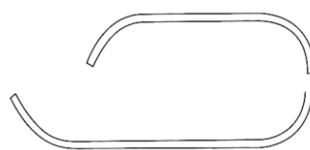

J-33-872
30 x 12; 35 x 16 mm

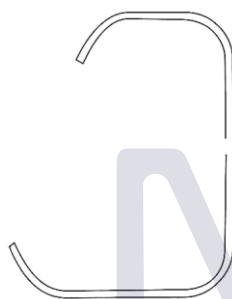

J-33-860
20 x 7; 30 x 10 mm

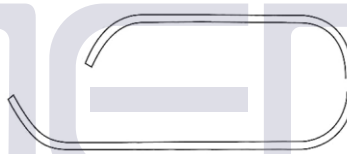

J-33-874
35 x 12; 45 x 16 mm

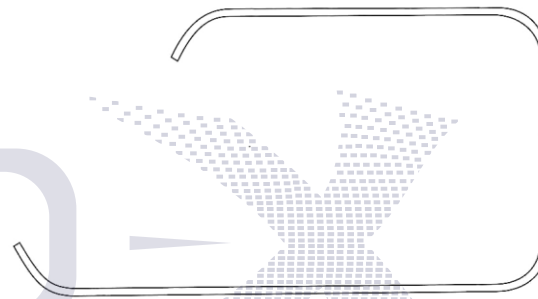

J-33-880
50 x 12; 70 x 16 mm

SURGICAL DISTRIBUTION



Tessier
J-33-2011
15 cm / 6"
Black chromium plated



Tessier
J-33-2017
15.5 cm / 6"
Black chromium plated



Tessier
J-33-2018
15.5 cm / 6"
Black chromium plated

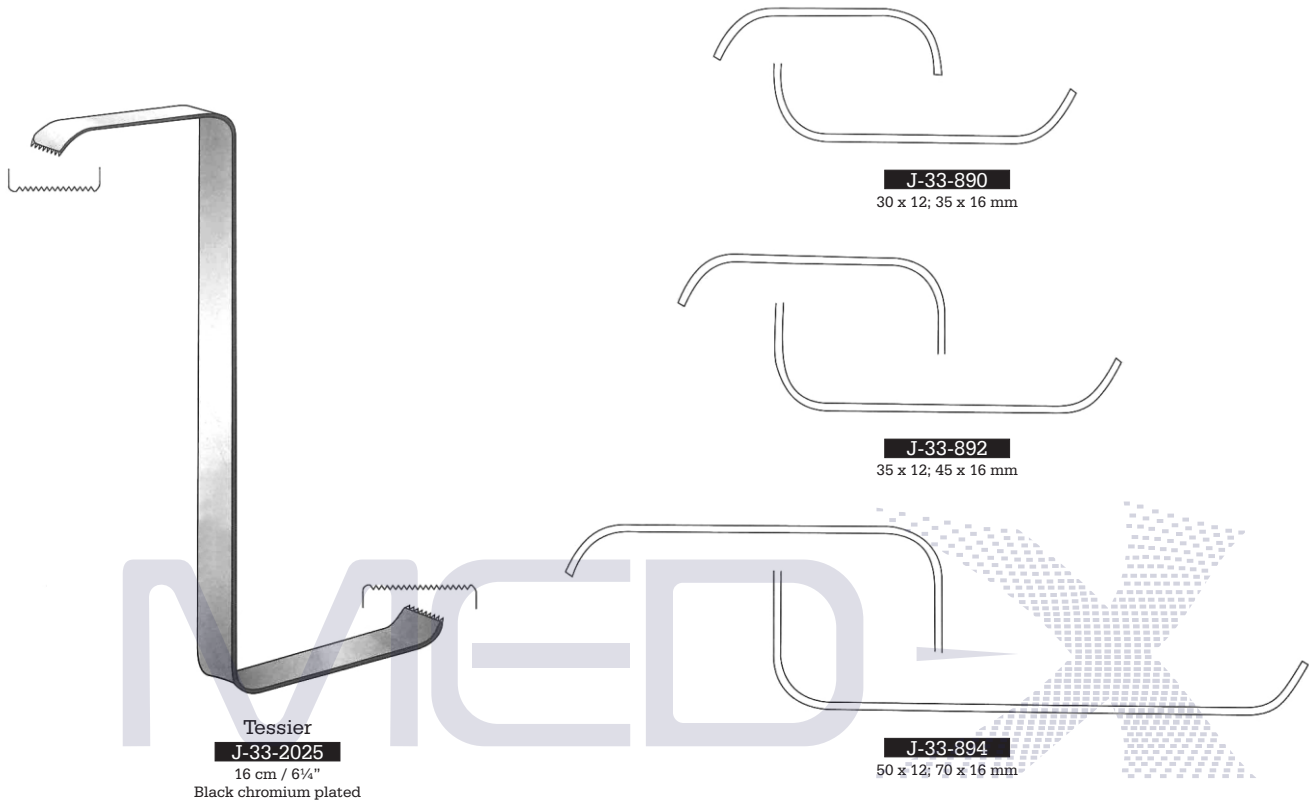

SURGICAL DISTRIBUTION

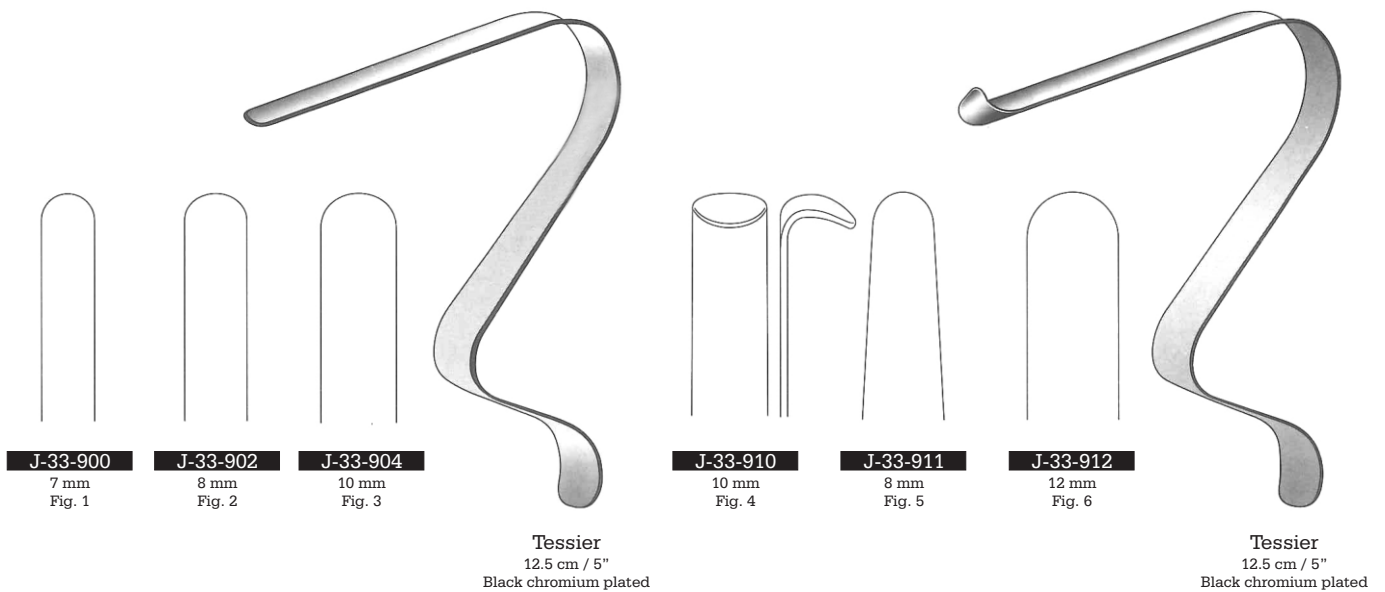

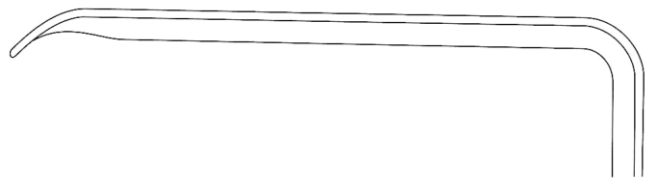

J-33-926
16 x 80 mm

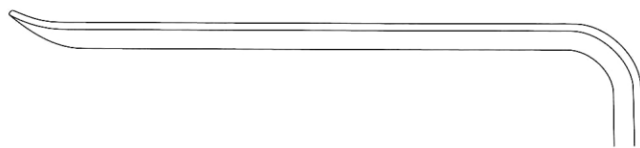

J-33-956
16 x 80 mm



J-33-925
14 x 70 mm



J-33-955
14 x 70 mm



J-33-924
12 x 55 mm



J-33-954
12 x 55 mm

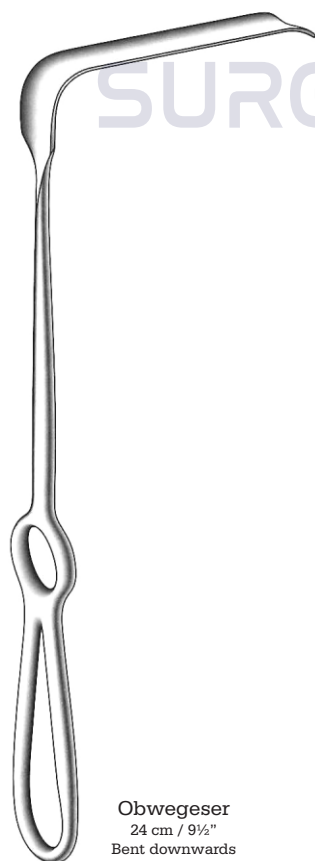

Obwegeser
24 cm / 9½"
Bent downwards



J-33-923
10 x 42 mm

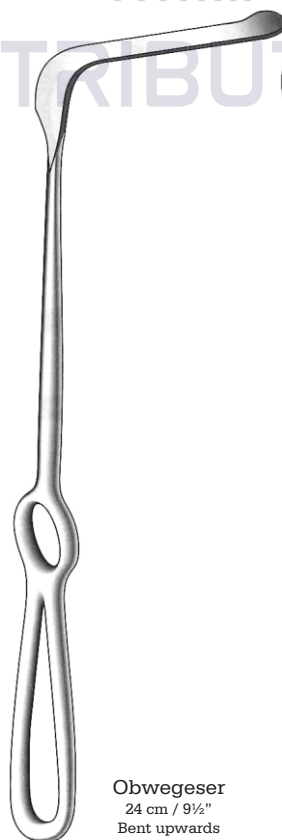

Obwegeser
24 cm / 9½"
Bent upwards



J-33-953
10 x 42 mm



J-33-922
10 x 35 mm



J-33-952
10 x 35 mm



J-33-921
7 x 25 mm



J-33-951
7 x 25 mm

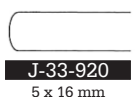

J-33-920
5 x 16 mm

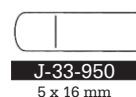

J-33-950
5 x 16 mm

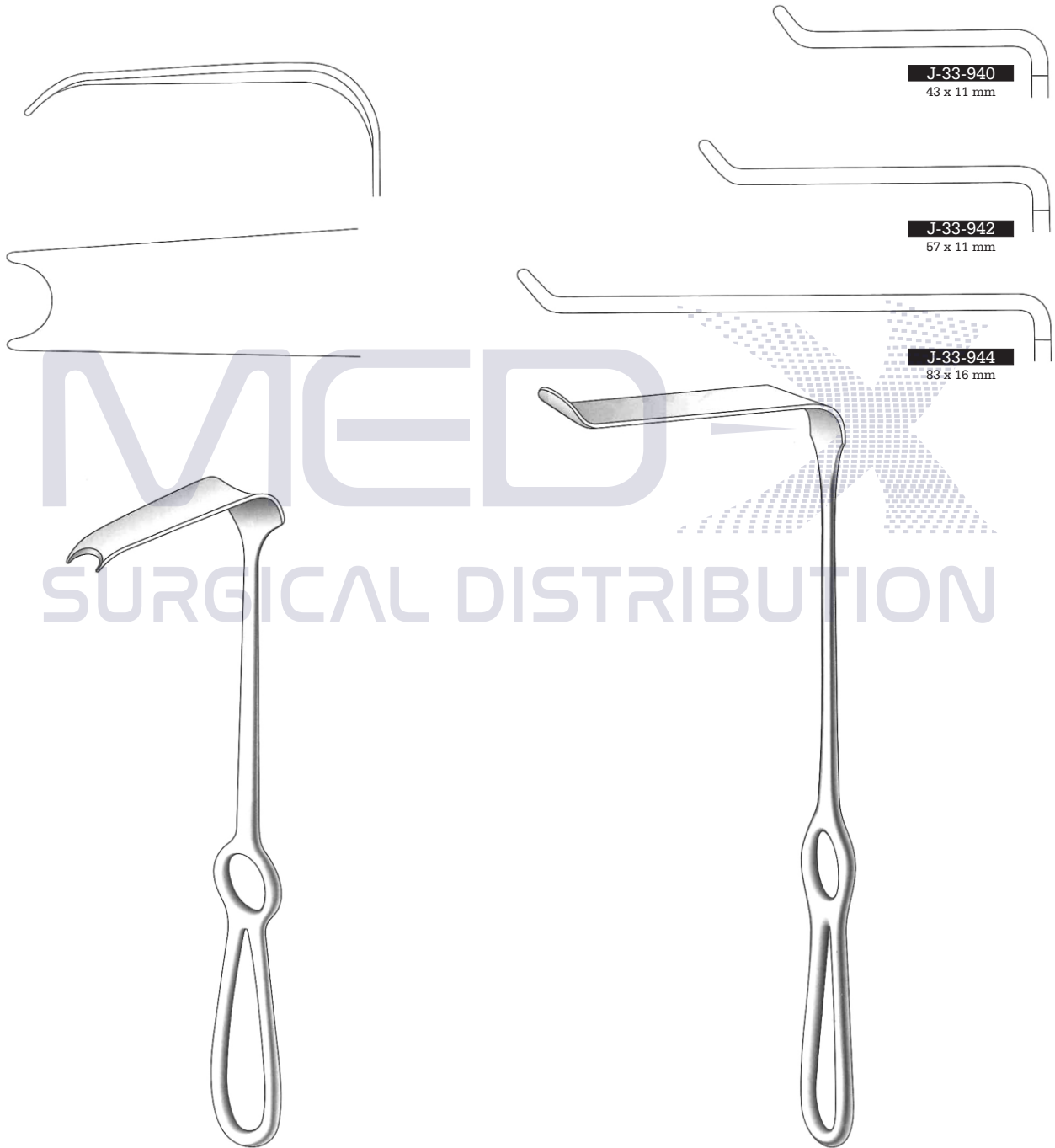

Obwegeser
J-33-930
24 cm / 9½"
15/22 x 70 mm
Third molar retractor

Obwegeser
21.5 cm / 8½"

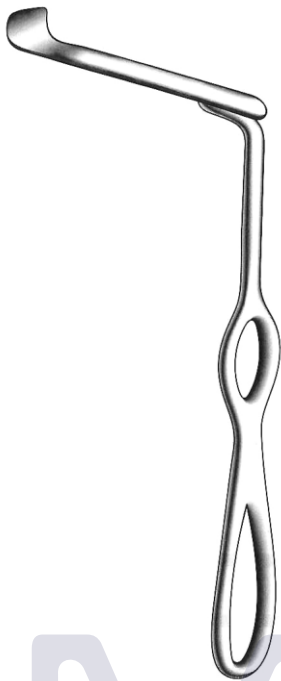

Schuchardt
J-33-960
15 cm / 6"

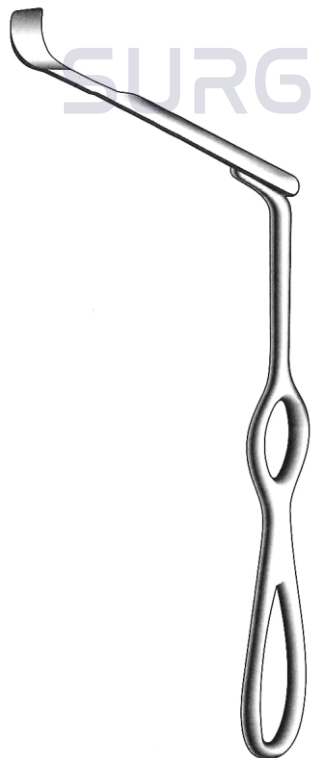
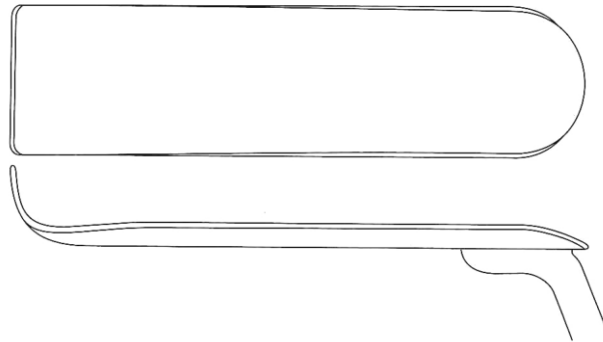

Metz
J-33-970
15 cm / 6"

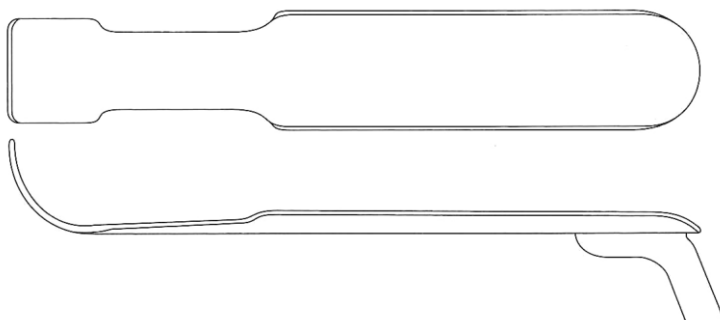

MEDIX
SURGICAL DISTRIBUTION

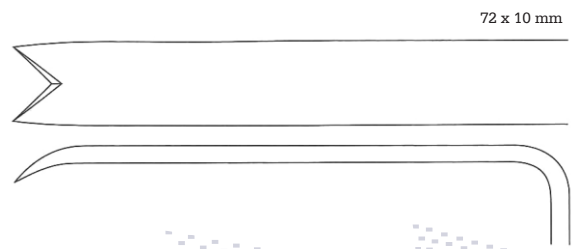
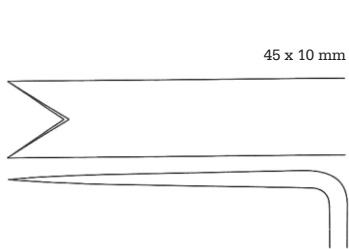

MED 
SURGICAL DISTRIBUTION

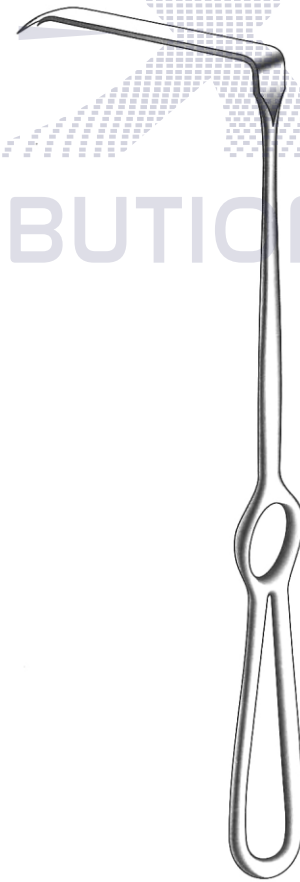
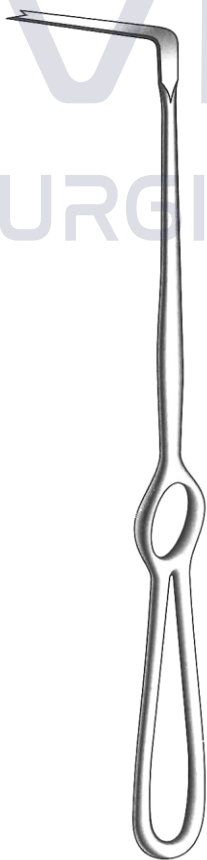

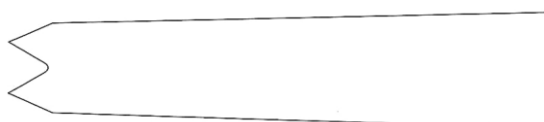

J-33-1000
11/15 x 70 mm

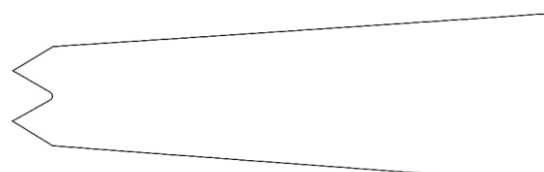

J-33-1002
12/22 x 70 mm

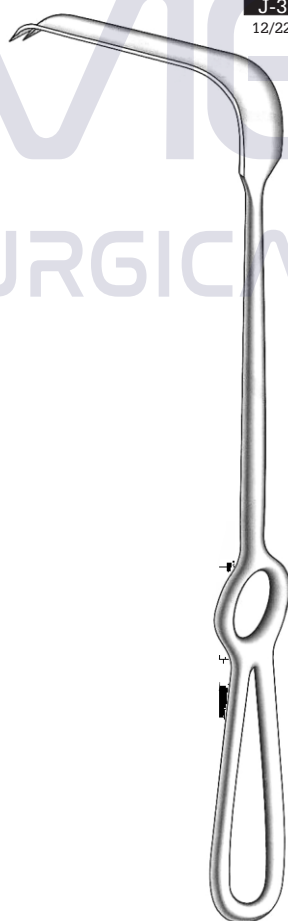

Obwegeser
24.5 cm / 9³/₄"

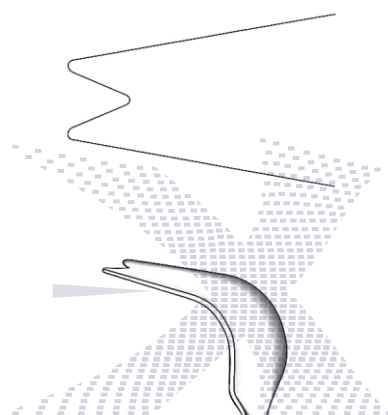

Obwegeser
J-33-1010
24.5 cm / 9³/₄"
10/23 x 40 mm
Nasal spine retractor

MED
SURGICAL DISTRIBUTION



J-33-1020
9/12 x 30 mm



J-33-1022
9/12 x 45 mm



J-33-1024
9/12 x 60 mm

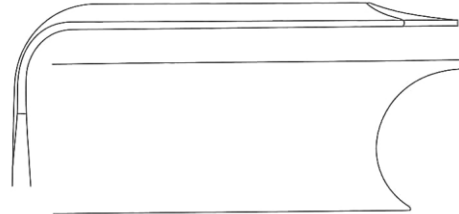

J-33-1030
Left

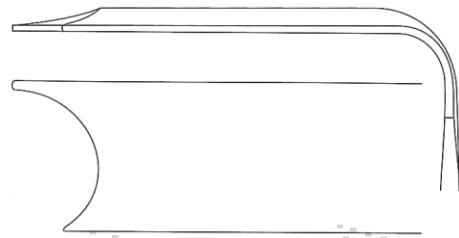

J-33-1032
Right

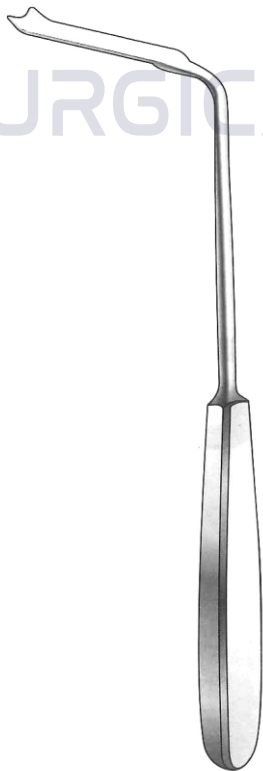

Obwegeser
21 cm / 8¼"

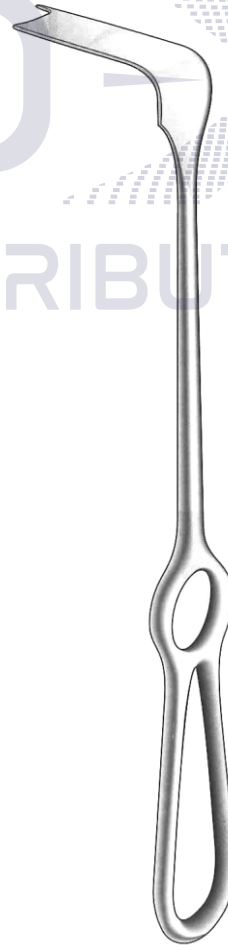

Steinhauser
23 cm / 9"
20 x 50 mm

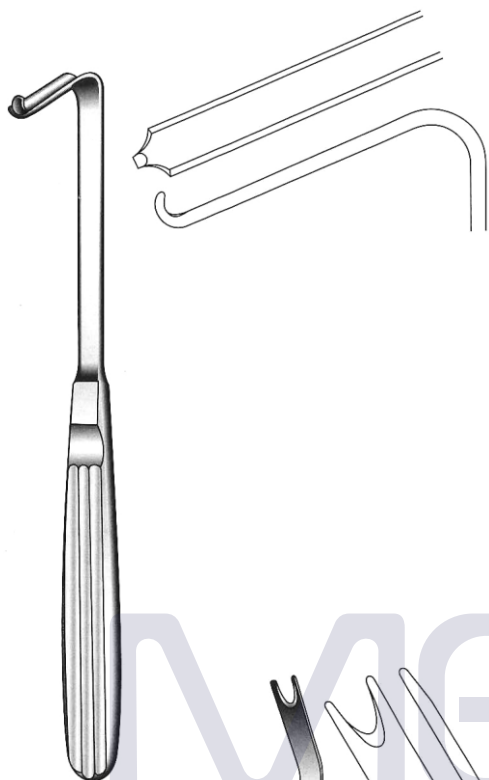

Hargis
J-33-1040
18.5 cm / 7¼"

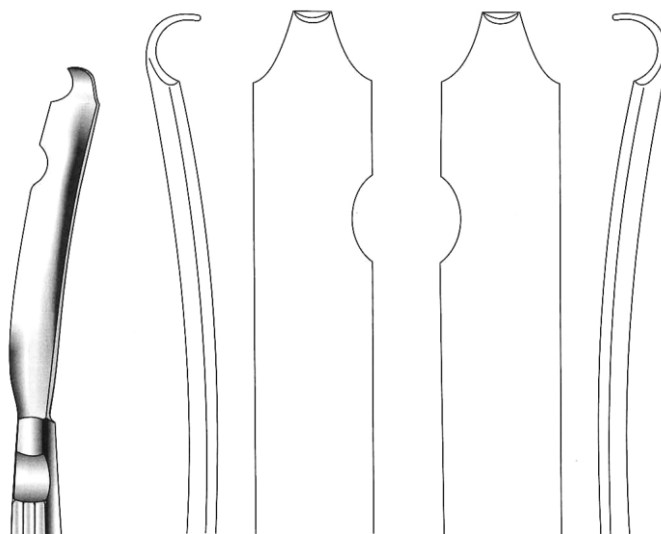

J-33-1050
Right

J-33-1052
Left

Hargis
19.5 cm / 7¾"

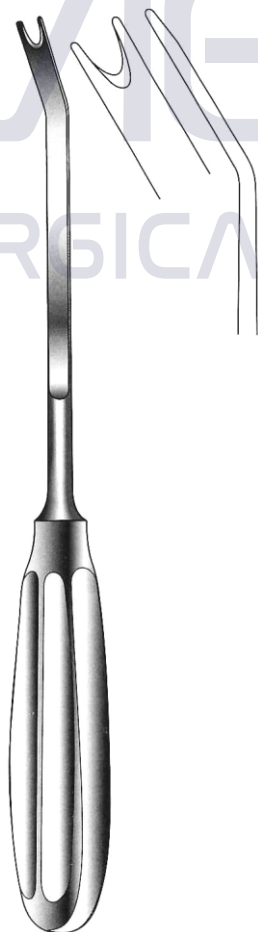

Terry
J-33-1060
24 cm / 9½"
Ramus pusher

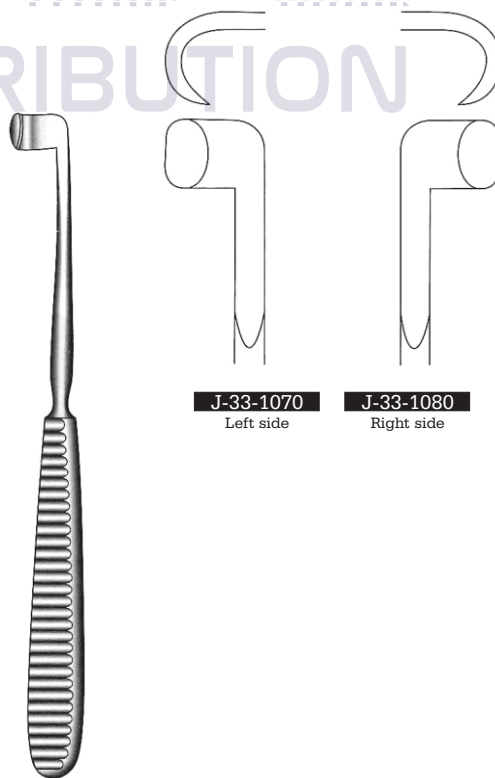

J-33-1070
Left side

J-33-1080
Right side

Obwegeser
18 cm / 7"

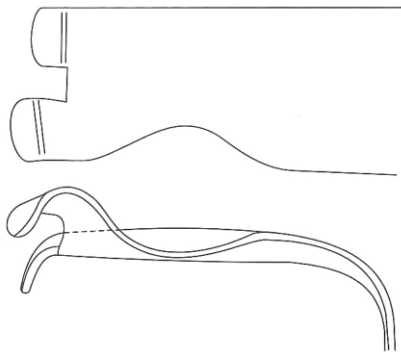

J-33-1090
Left

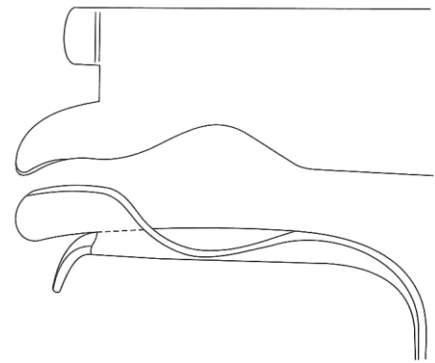

J-33-1100
Left

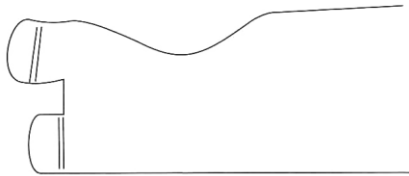

J-33-1092
Right

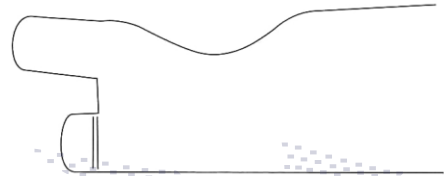

J-33-1102
Right

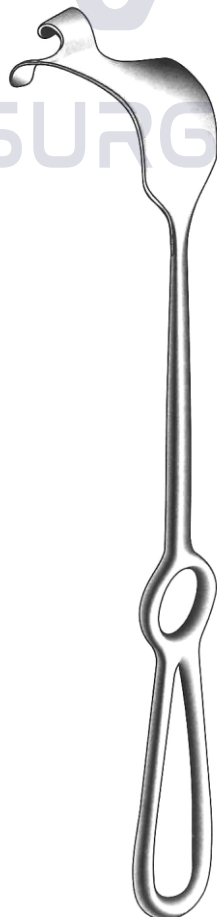

Arnhem
22 cm / 8 3/4"
LeFort 1 retractor



Arnhem
22 cm / 8 3/4"
Sinus lift retractor

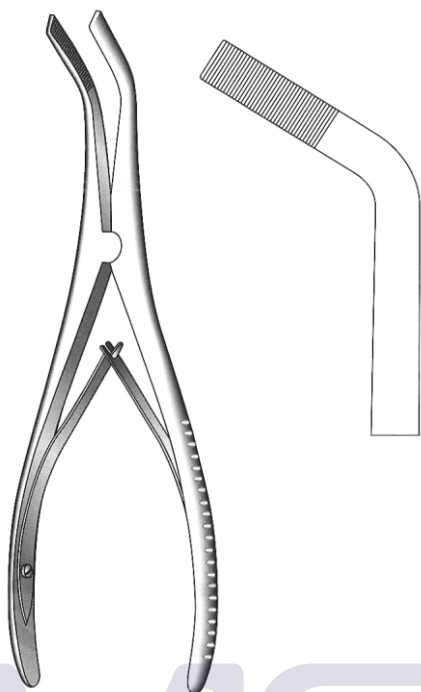

Tessier
J-33-1110
17.5 cm / 7"
7mm
Spreading forceps

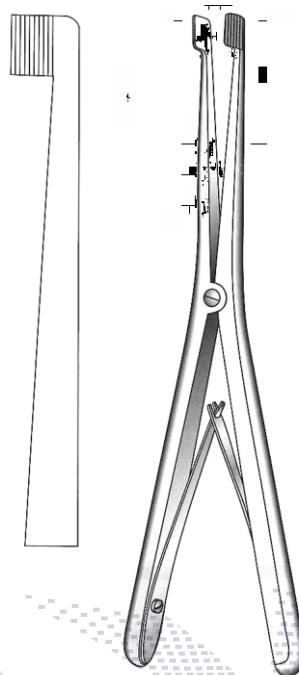

Turvey
J-33-1420
17 cm / 6 3/4"
Palatal expander

MEDIX
SURGICAL DISTRIBUTION

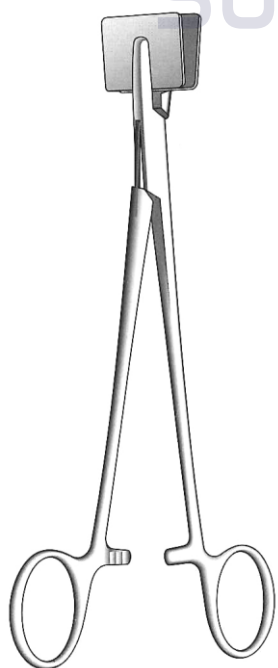

Sheehy Fascia Press
J-33-1430
19 cm / 7 1/2"
23 x 31 mm Plate

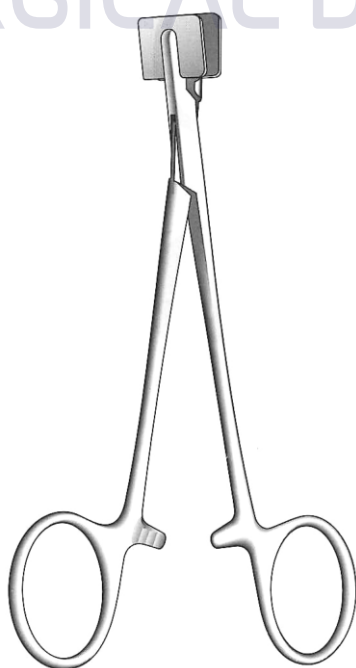

House Gelfoam Press
J-33-1434 13 cm / 5"
J-33-1435 19 cm / 7 1/2"
16 x 12 mm Plate

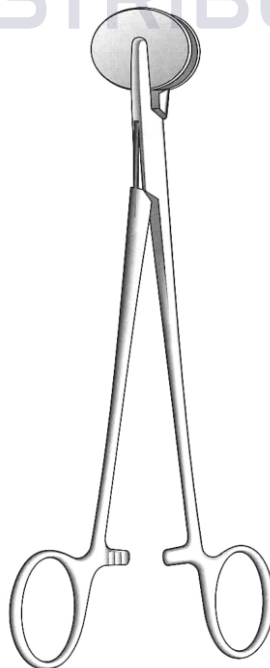

Sheehy Fascia Press
J-33-1440
19 cm / 7 1/2"
23 x 31 mm Round Model

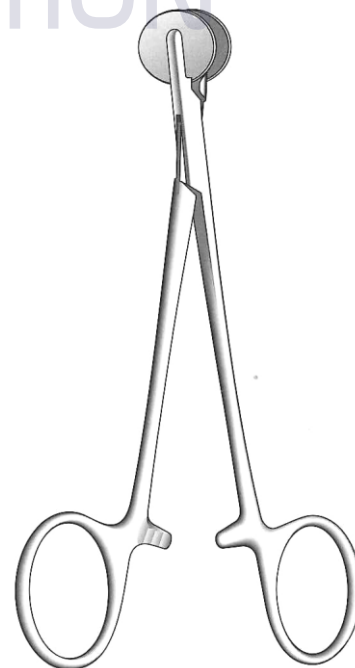

House Gelfoam Press
J-33-1445 13 cm / 5"
J-33-1446 19 cm / 7 1/2"
16 x 12 mm Round Model

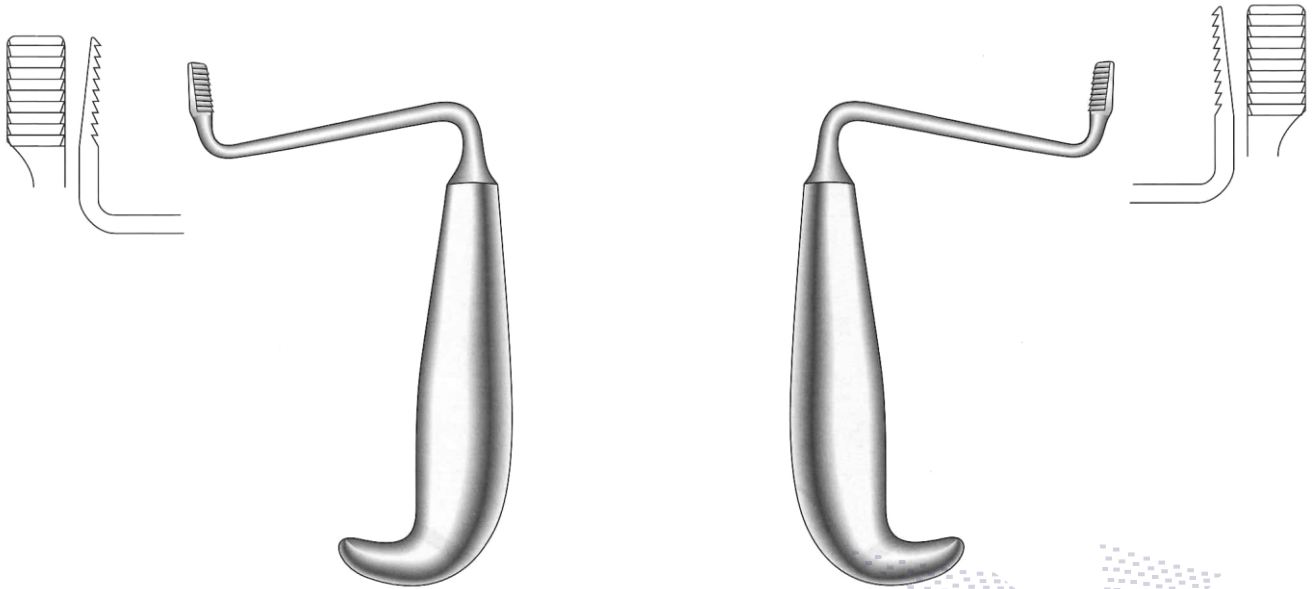

Tessier
J-33-1120
 15 cm / 6"
 9 mm
 Right

Tessier
J-33-1130
 15 cm / 6"
 9 mm
 Left



Hargis
J-33-1140
 18 cm / 7"

Dingmann Wilk
J-33-1150
 20 cm / 8"

Hargis
J-33-1160
 19 cm / 7½"

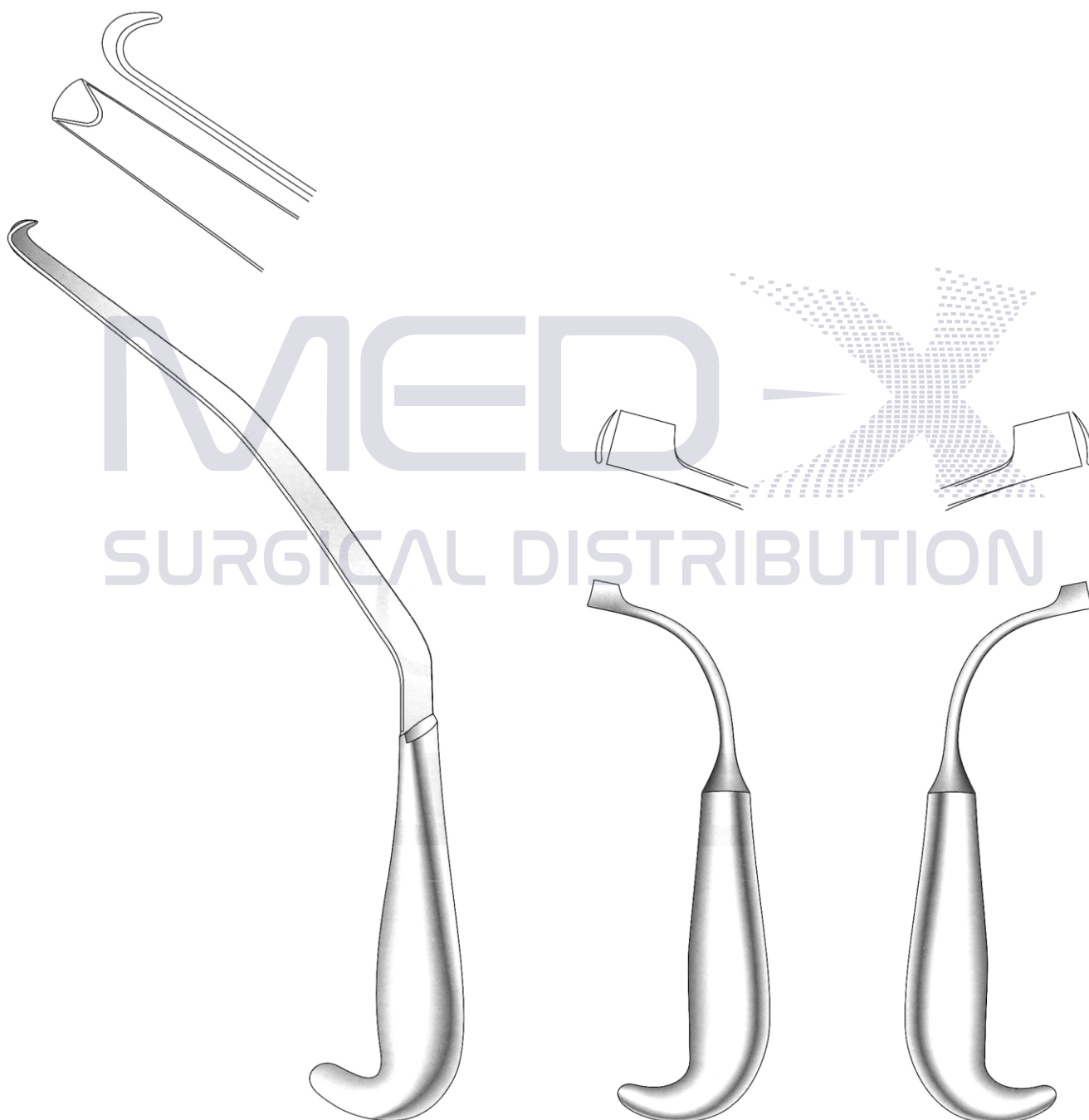

Steinhauser
J-33-1170
27 cm / 10½"
Extra long channel retractor

Smith
J-33-1400
18.5 cm / 7¼"
9 mm, Right

Smith
J-33-1405
18.5 cm / 7¼"
9 mm, Left

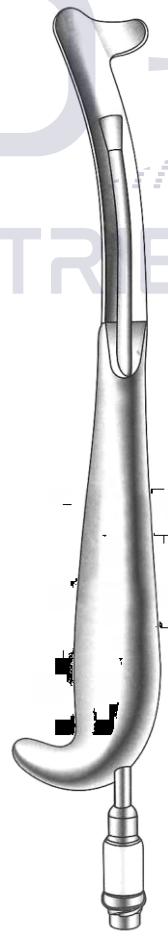
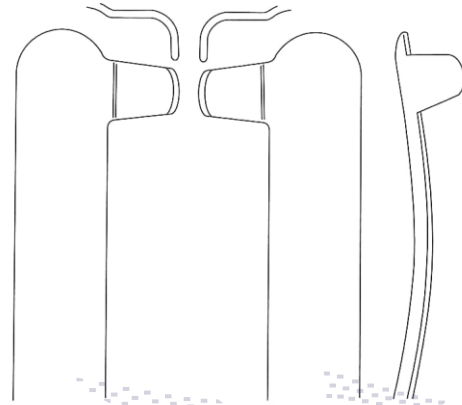
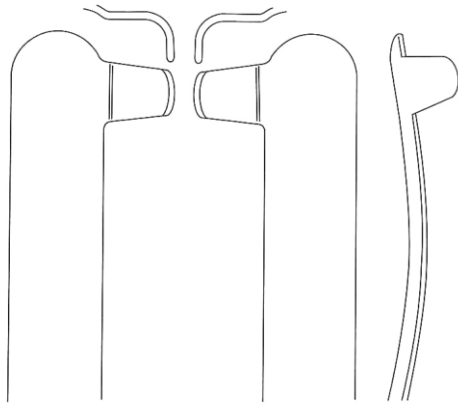

J-33-1180
 21 cm / 8¼"
 26.5 / 16 mm
 Right

J-33-1190
 21 cm / 8¼"
 26.5 / 16 mm
 Left

J-33-1250
 24.5 cm / 9¾"
 26.5 / 16 mm
 Right
 with fiber optic light carrier

J-33-1260
 24.5 cm / 9¾"
 26.5 / 16 mm
 Left
 with fiber optic light carrier

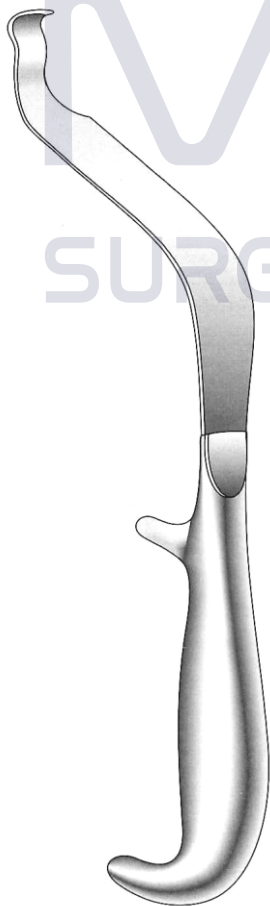

J-33-1200
25 cm / 9³/₄"
12.5 / 27 mm
L&M. for vertical osteotomy



J-33-1210
22 cm / 8³/₄"
9.5 / 16 mm
Concave blade, fully bent tip
Extra oral retractor

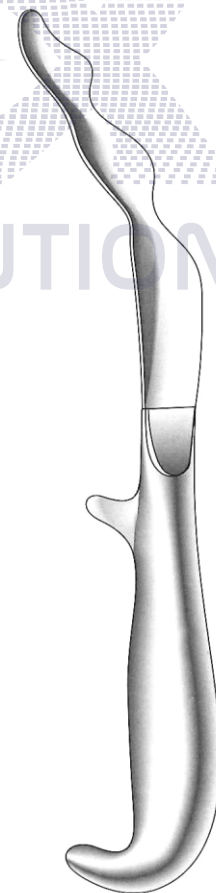

J-33-1220
23 cm / 9"
25.5 mm
For LeFort osteotomies

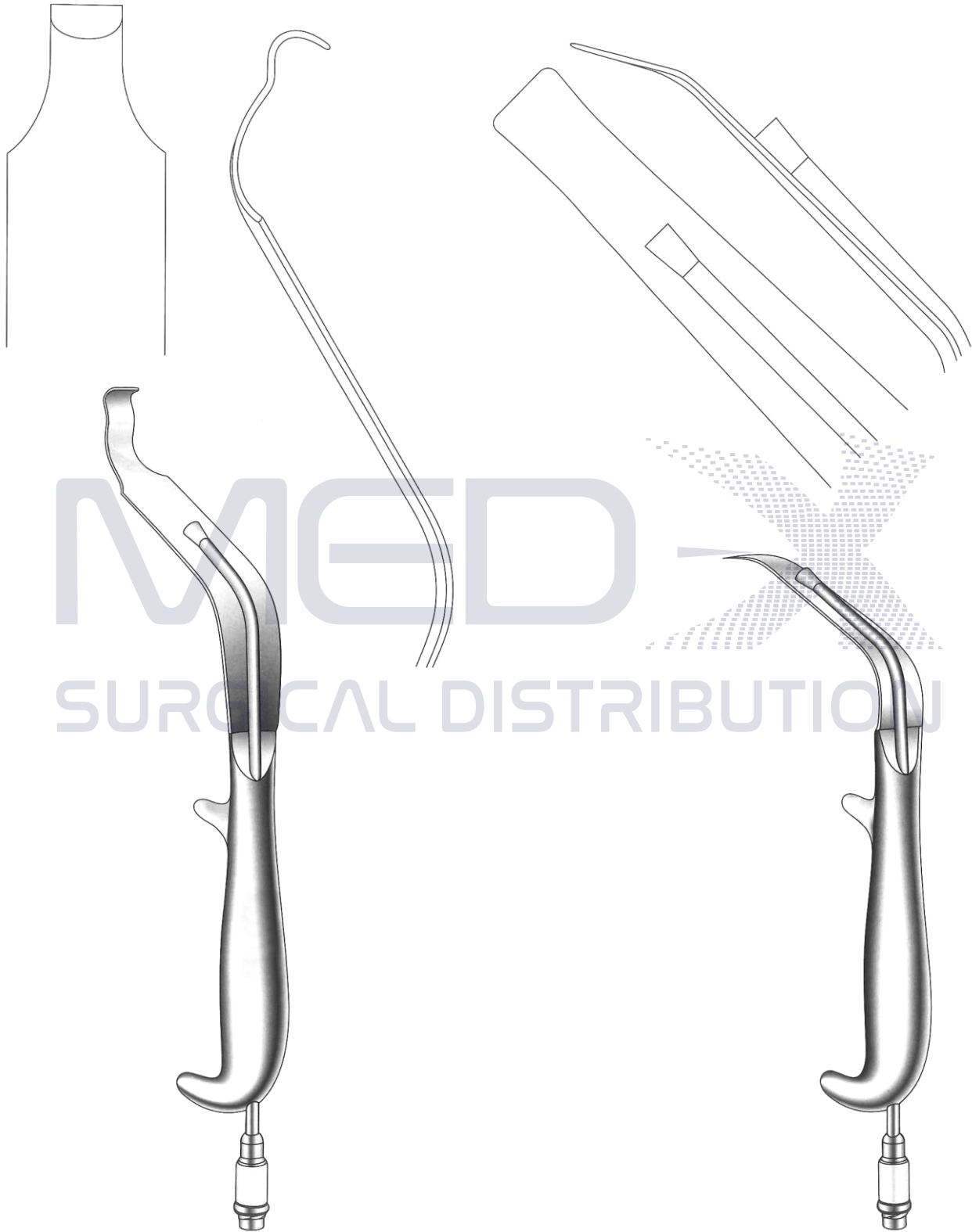

J-33-1230
28 cm / 11"
12.5 / 27 mm
L&M, for vertical osteotomy
with fiber optic light carrier

Shea
J-33-1240
22 cm / 8 3/4"
14.5 mm
Multi purpose retractor
with fiber optic light carrier

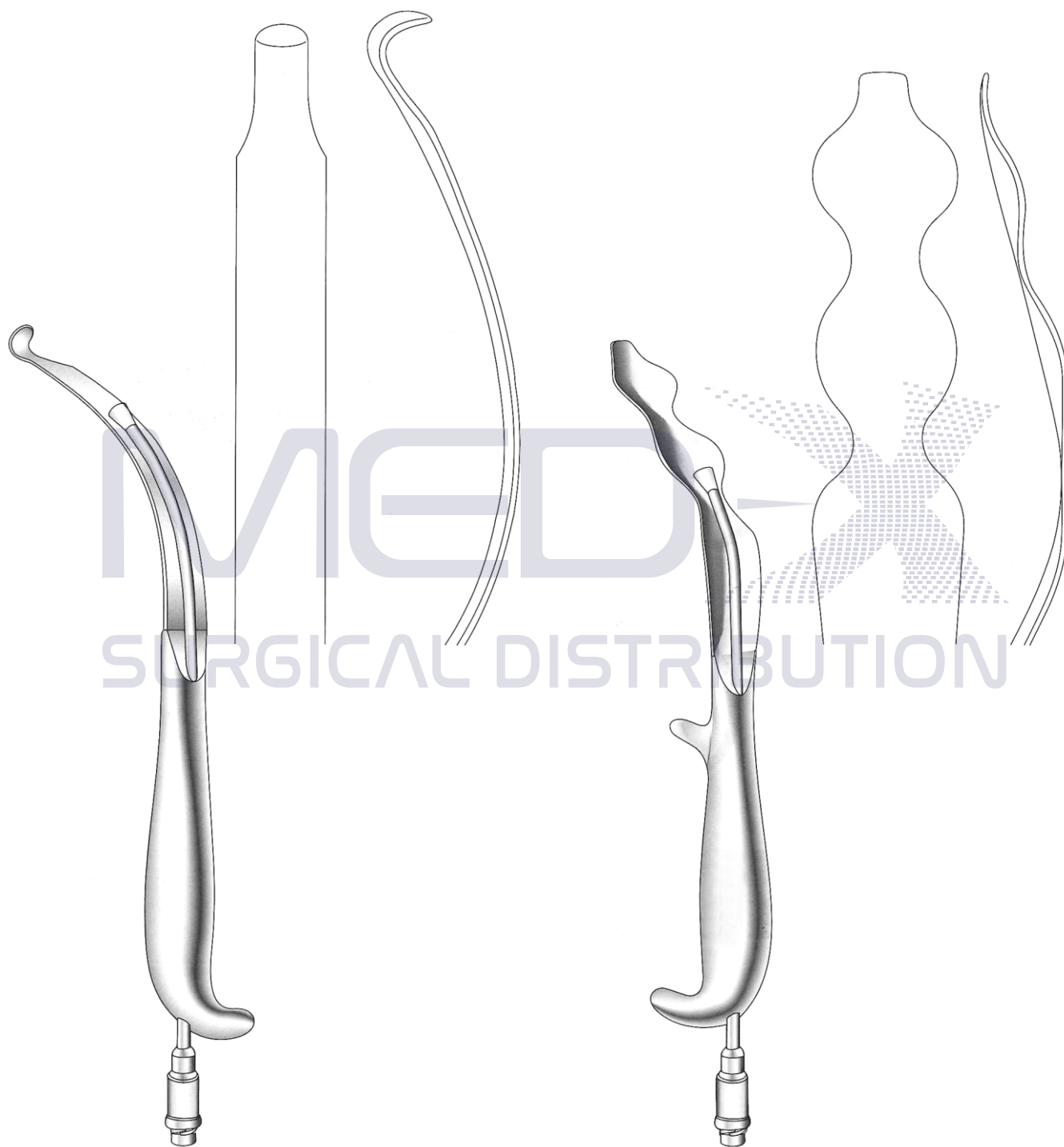

J-33-1270

25.5 cm / 10"
9.5 / 16 mm

Concave blade, fully bent tip
Extra oral retractor
with fiber optic light carrier

J-33-1280

27 cm / 10¾"
25.5 mm

For LeFort osteotomies
Intra oral retractor
with fiber optic light carrier

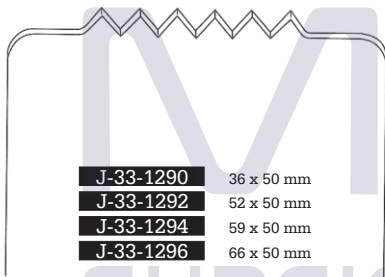
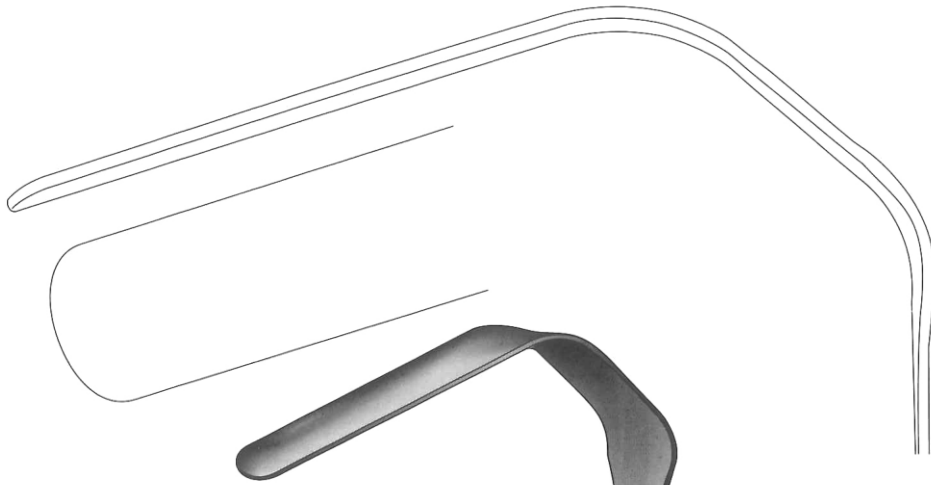

J-33-1290	36 x 50 mm
J-33-1292	52 x 50 mm
J-33-1294	59 x 50 mm
J-33-1296	66 x 50 mm



Tessier
 16 cm / 6¼"
 Black chromium plated



Tessier
J-33-1300 90 x 22 mm
J-33-1302 120 x 28 mm
 20.5 cm / 8"
 Black chromium plated



Breast Retractor
J-20-1674
 22 cm / 8½"
 80 x 30 mm, 50 x 23 mm
 Double Ended

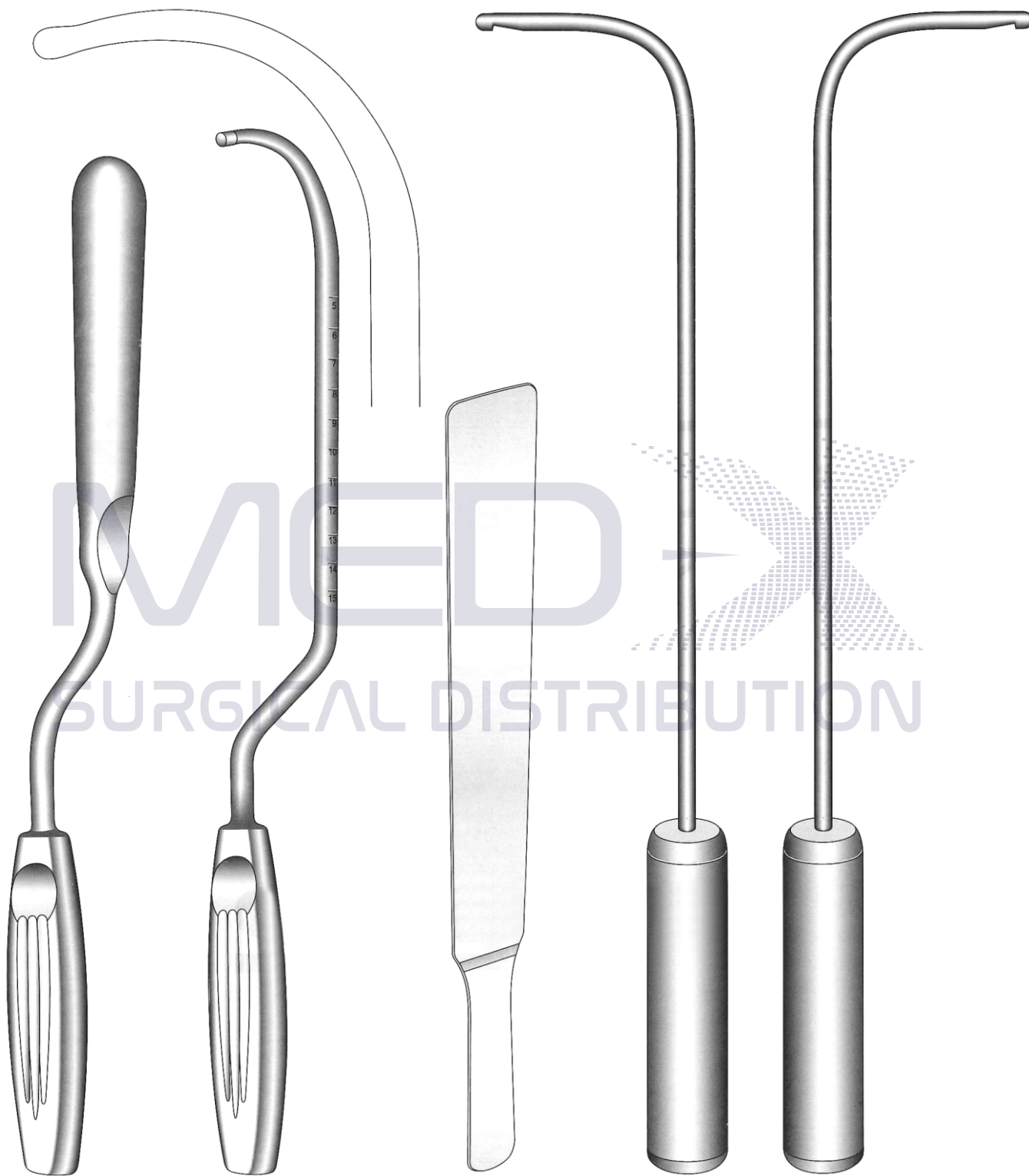

Solz

J-33-2001 34 cm / 13 $\frac{3}{8}$ "
J-33-2002 37 cm / 14 $\frac{1}{2}$ "
Atraumatic breast dissector

Solz

J-33-2015
36 cm / 14 $\frac{1}{4}$ "
Hook dissector
for fine contouring of the
implant-bed

Spatula

J-20-1958
20 cm x 2.5 cm
J-20-1959
20 cm x 4 cm

J-19-1252
Left

J-19-1254
Right

Agris Dingman Transauxillary
Breast Dissectors
J-19-1250
Pair
40 cm / 15 $\frac{3}{4}$ "



Agris Dingman
J-20-1967
23 cm / 9"
Left, 5 cm
Breast Dissector



Agris Dingman
J-20-1968
23 cm / 9"
Right, 5 cm
Breast Dissector



Agris Dingman
J-20-1962
23 cm / 9"
Left, 5 cm
Breast Dissector



Agris Dingman
J-20-1963
23 cm / 9"
Right, 5 cm
Breast Dissector



MacCollum
J-19-1260
31.5 cm / 12½"
Angled Shaft
Dingman Transauxillary
Breast Retractor



Reynolds
J-19-1270
33 cm / 13"
Transauxillary Breast Dissector
Non Fenestrated for
breast and buttocks



MacCollum Dingman
J-20-1964
21 cm / 8¼"
2.5 cm x 4.5 cm
Breast Dissector



MacCollum Dingman
J-20-1965
24 cm / 9½"
3.5 cm x 6 cm
Breast Dissector



MacCollum Dingman
J-20-1966
25 cm / 9¾"
2.5 cm x 4.5 cm
Breast Dissector



Dissector
J-20-1956
22.5 cm / 9"
3 cm

Rod Dissector
J-20-1951
30 cm / 11¼"
10 mm Ø

Rod Dissector
J-20-1952
30 cm / 11¼"
15 mm Ø

SURGICAL DISTRIBUTION



Passway Dissector
J-20-1955
30 cm / 11¼"
10 mm Ø
Curved, 4 cm

Spatula Dissector
J-20-1953
26 cm / 10¼"
3.5 cm x 7.5 cm
Heart Type

Spatula Dissector
J-20-1954
26 cm / 10¼"
2.5 cm x 7.5 cm
Egg Type



Solz

- J-33-2021** Ø = 36 mm
- J-33-2022** Ø = 40 mm
- J-33-2024** Ø = 42 mm
- J-33-2026** Ø = 45 mm

Areola marker (Blunt)



Areola Markers

- J-25-0016** Ø = 38 mm
- J-25-0017** Ø = 40 mm
- J-25-0018** Ø = 42 mm
- J-25-0019** Ø = 45 mm



J-33-2031

For precise marking of the nipple during:
 -Combined Breast-Lifting
 -Reduction of the areola



J-33-2035

Ø = 6 cm (0.06 l)
 Bowl for marking colour

MED 
 SURGICAL DISTRIBUTION



Breast Reduction Marker

J-25-0026
 Set of 3

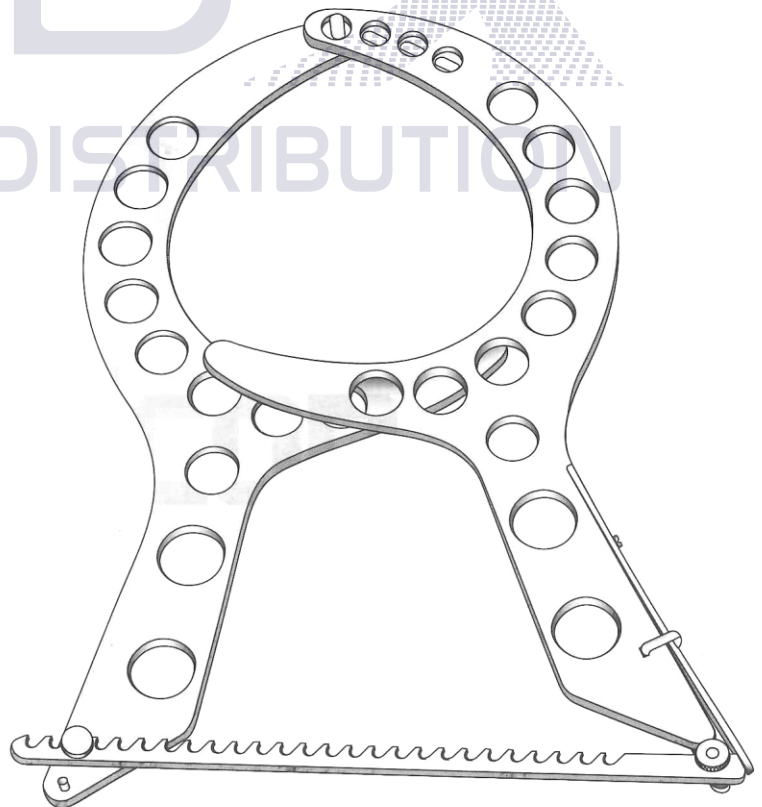

Breast Elevator

J-33-2040
 28 cm / 11"

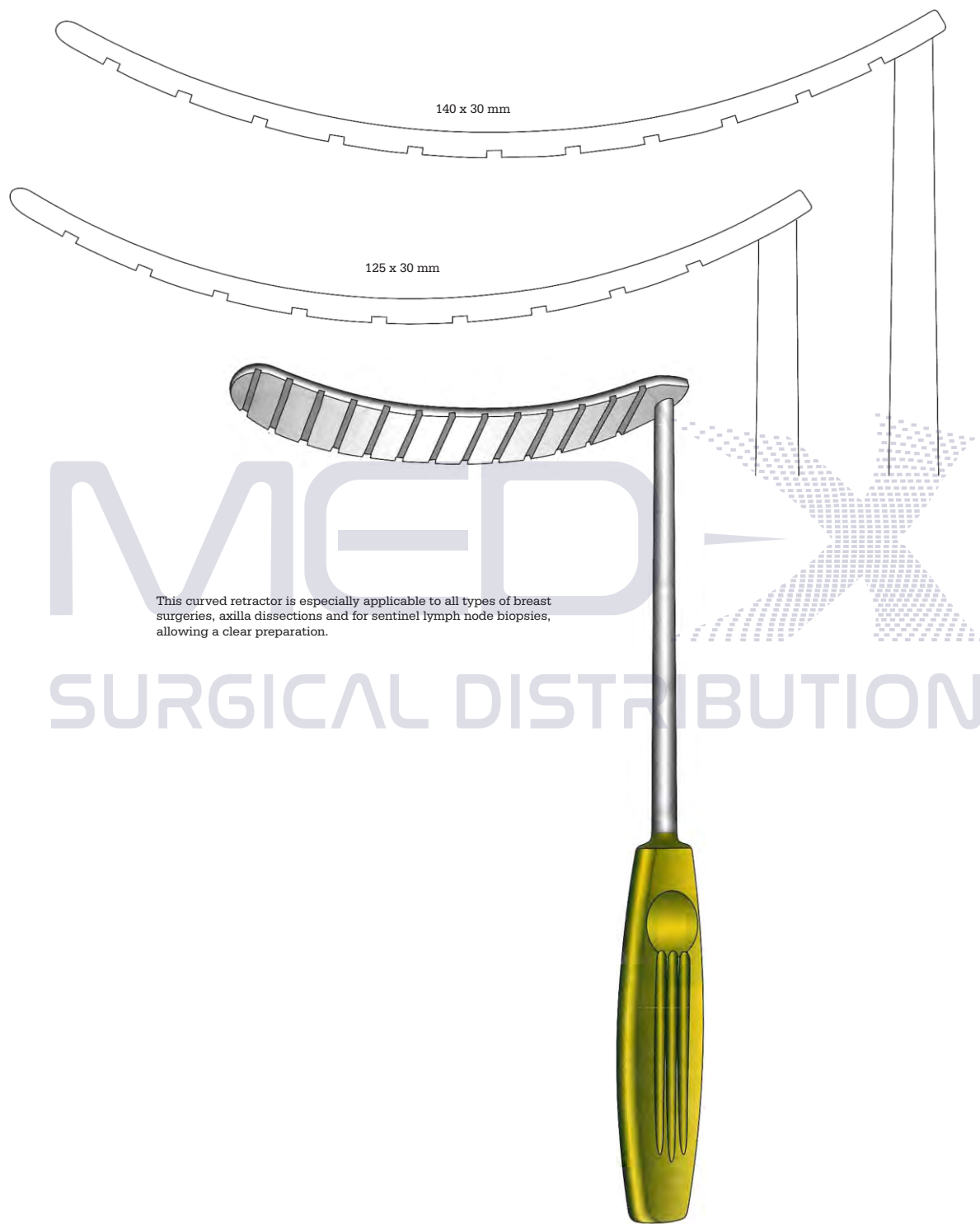

This curved retractor is especially applicable to all types of breast surgeries, axilla dissections and for sentinel lymph node biopsies, allowing a clear preparation.

SURGICAL DISTRIBUTION

Marx
J-32-0042 125 x 30 mm
J-33-0040 140 x 30 mm
27 cm / 10 3/4"

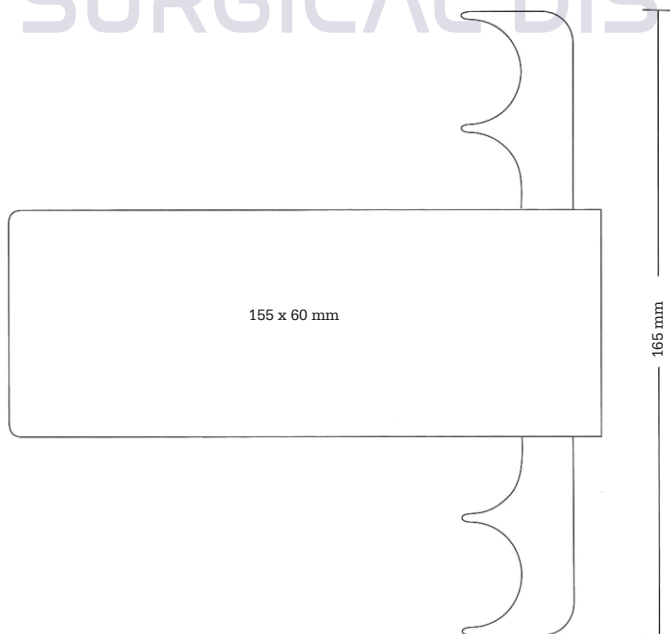
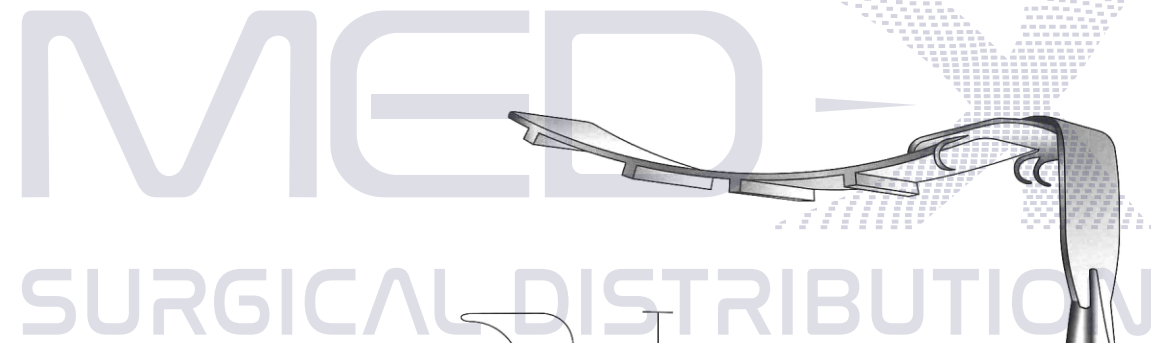
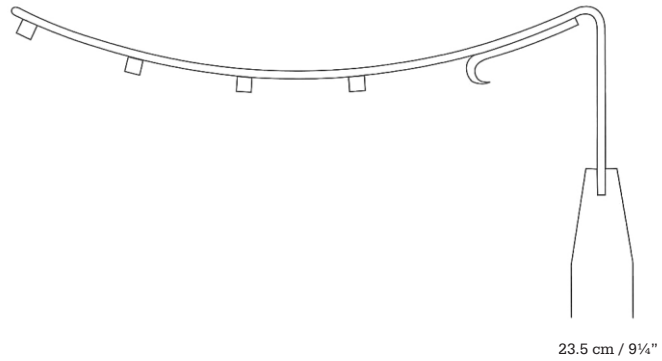

Atraumatic lifting of the dermocutaneous flap
High stability of the desired position
Excellent presentation of the operating field
Facilitates repair of rectus diastasis and abdominal fascia

Saldanha-Solz
J-33-2060

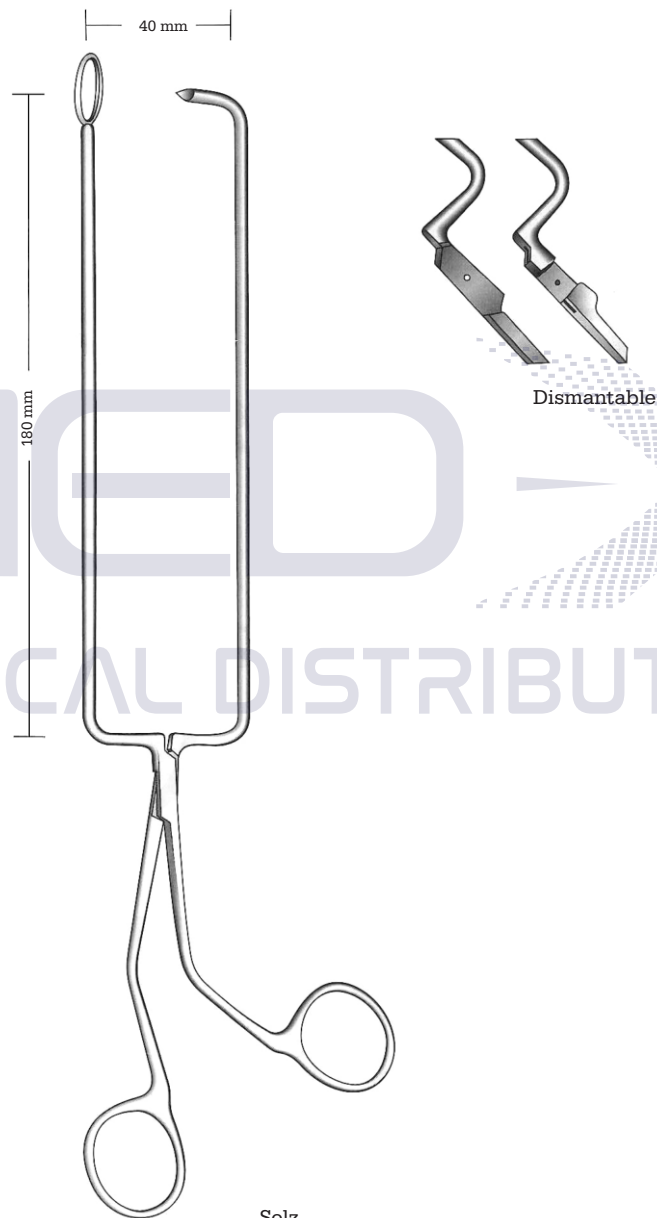

Solz
J-33-2070
29 cm / 11 $\frac{3}{8}$ "

Exact re-positioning of the navel in correspondence to the original position
Secure tracing of the naval position on the abdominal skin after lightening procedures
Sufficient span length also for thicker abdomen

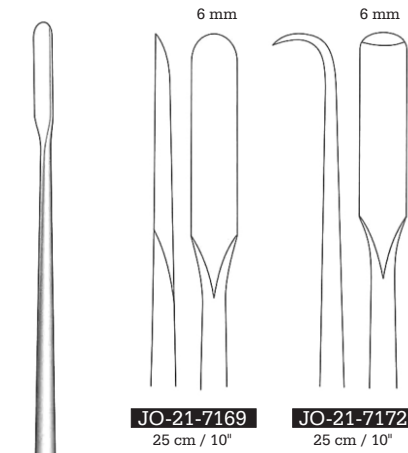

Novotex
Pastic handle autoclavable up to 134° C



Novotex Handle
25 cm / 10"



Novotex Handle
25 cm / 10"

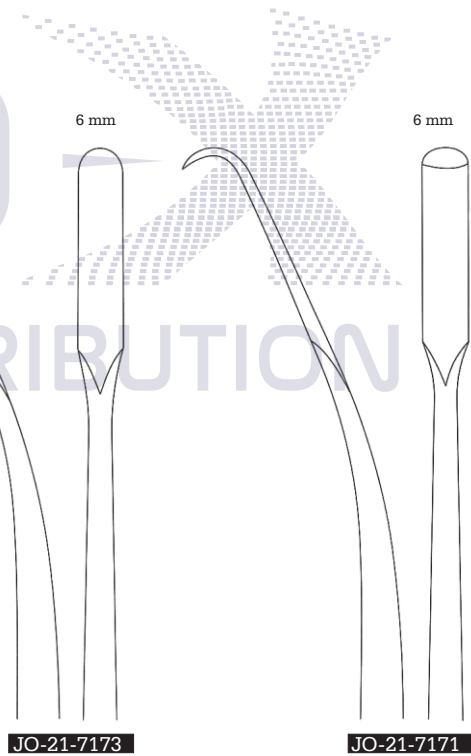

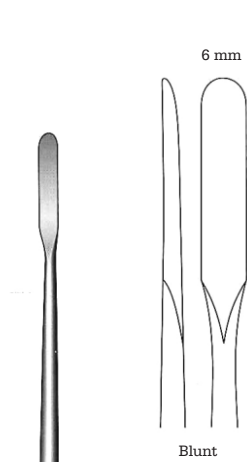

Blunt

Novotex
JO-21-7170
25 cm / 10"
Ferrozell Handle

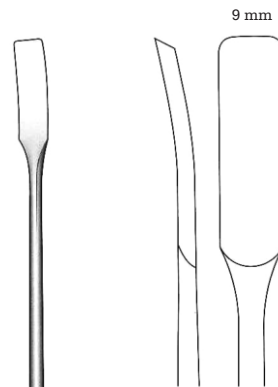

9 mm

J-33-2110
27.5 cm / 10 3/4"



Blunt

JO-21-7174
25 cm / 10"
Ferrozell Handle

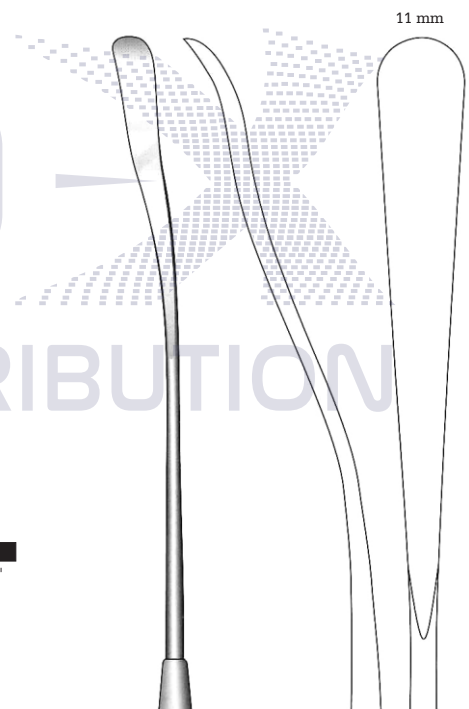

11 mm

J-33-2130
27.5 cm / 10 3/4"

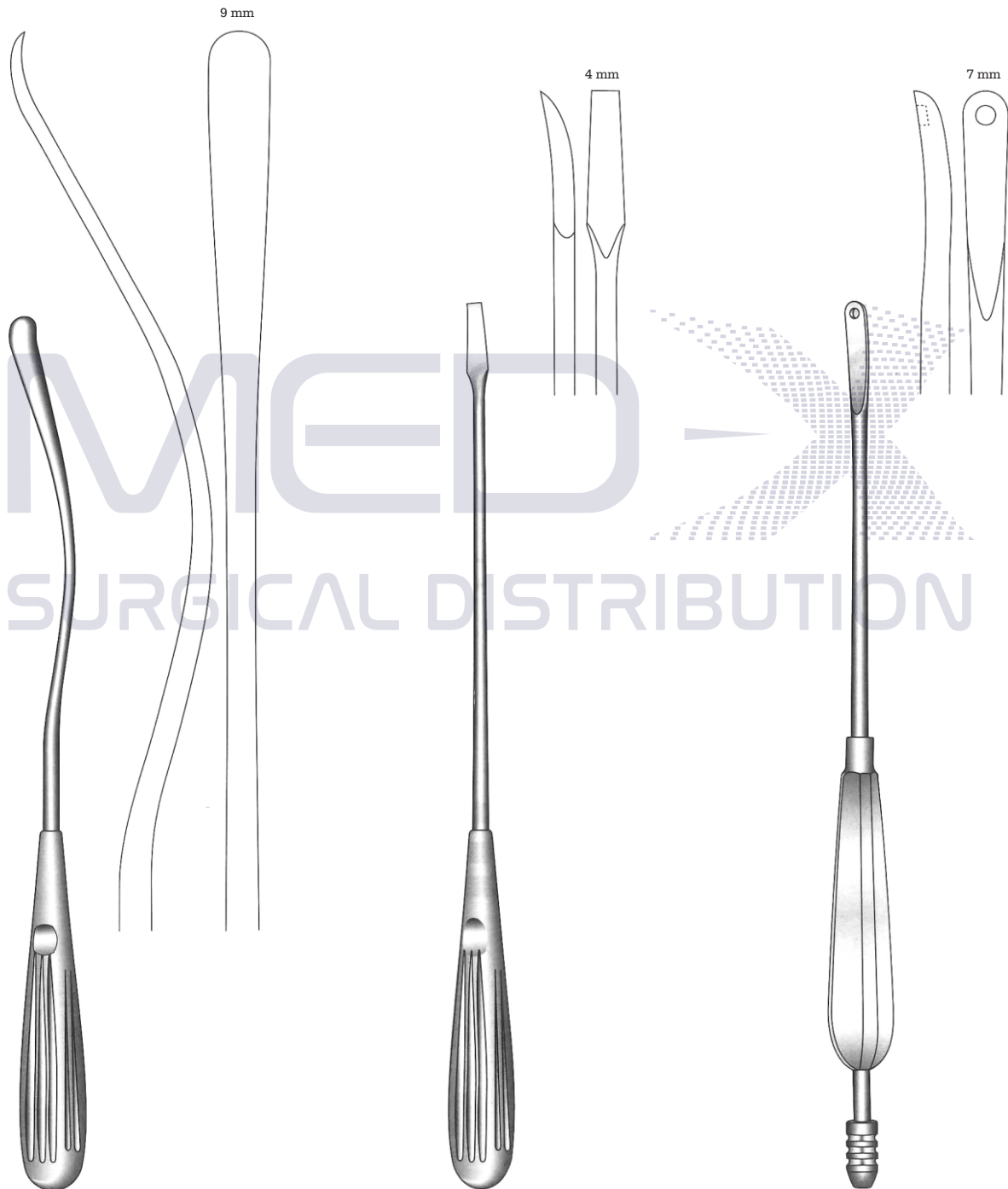

J-33-2140
27 cm / 10 $\frac{3}{4}$ "

J-33-2150
27.5 cm / 10 $\frac{3}{4}$ "

J-33-5002
27.5 cm / 10 $\frac{3}{4}$ "
Tube connection



Forehead Retractor
J-33-1087
Gold Plate Handle
J-33-10870
Stainless Steel

Forehead Retractor
J-33-1081
Gold Plate Handle
J-33-10810
Stainless Steel

Forehead Retractor
J-33-1088
Gold Plate Handle
J-33-10880
Stainless Steel

Forehead Retractor
J-33-1083
Gold Plate Handle
J-33-10830
Stainless Steel

Forehead Retractor
J-33-1086
Gold Plate Handle
J-33-10860
Stainless Steel

Forehead Retractor
J-33-1082
Gold Plate Handle
J-33-10820
Stainless Steel





J-22-2190
28 cm / 11"

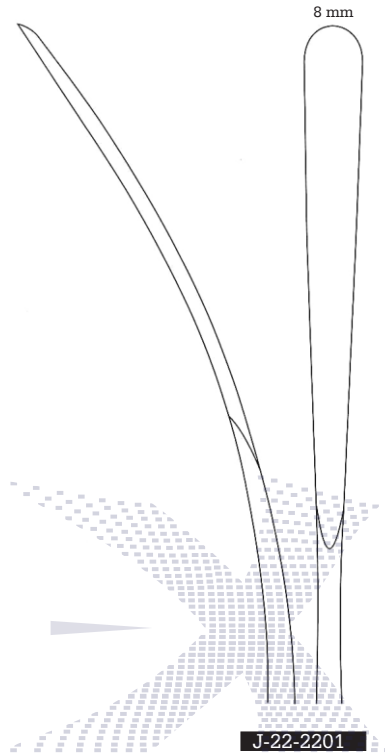

J-22-2201
27 cm / 10 3/4"

MEDICAL
SURGICAL DISTRIBUTION

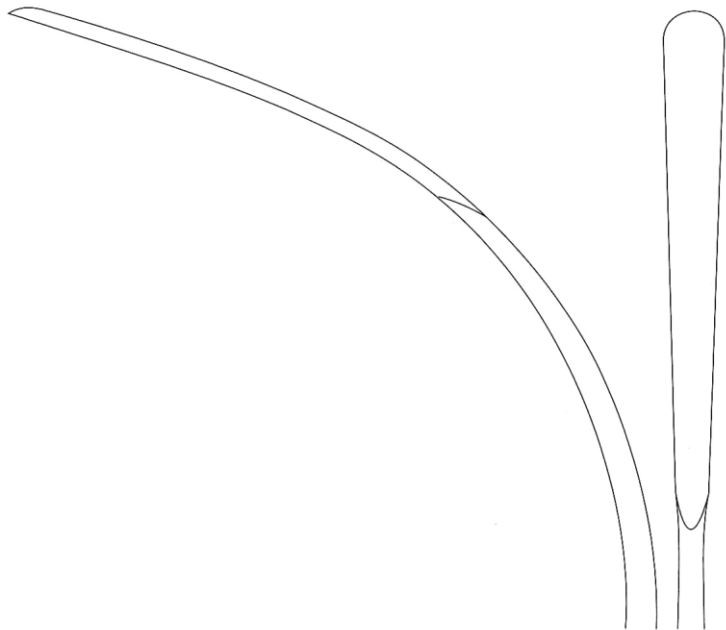

J-22-2210
24 cm / 9 1/2"

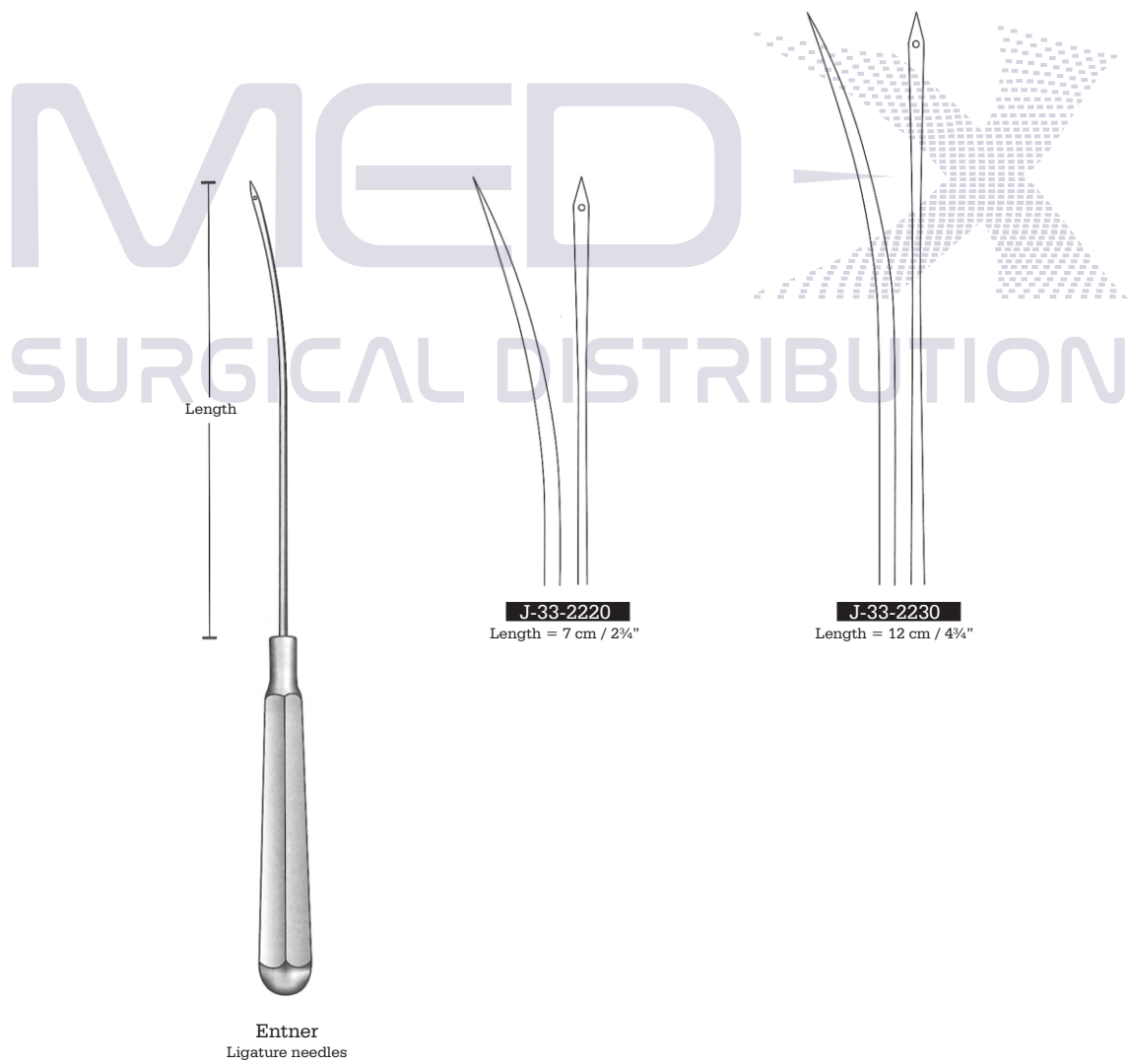

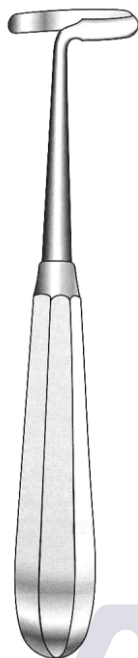

Doyen
17 cm / 6 3/4"

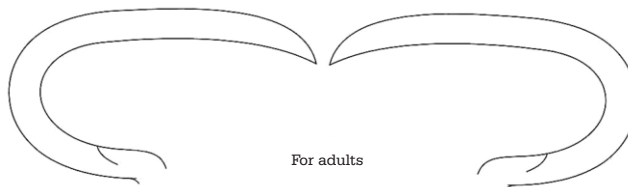

For adults

JO-21-686

Right

JO-21-687

Left

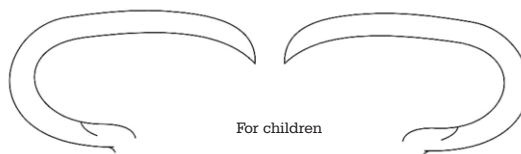

For children

JO-21-688

Right

JO-21-689

Left

MEDIX
SURGICAL DISTRIBUTION

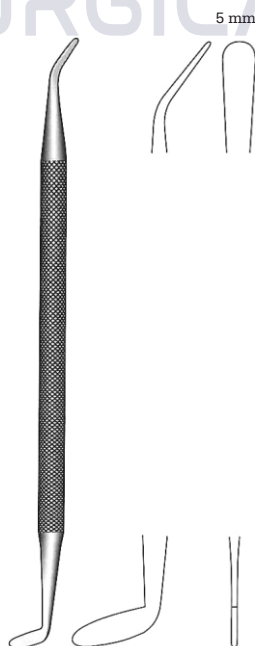

Nagata
J-33-2240
16 cm / 6 1/4"
Elevator, Blunt

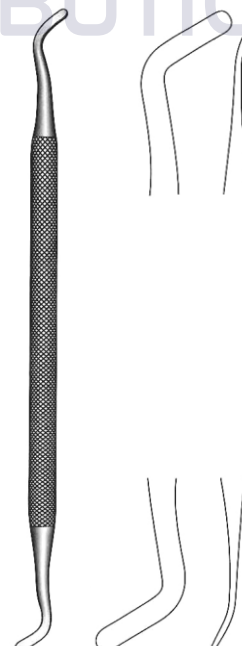

Nagata
J-33-2250
17 cm / 6 1/4"
Elevator, Blunt



Dingman
 15 cm / 6"
 Cartilage abraders

Dingman
 16 cm / 6 1/4"

Advantages

Improved handling due to its anatomical, S-shaped design.
 Simple dissection of the anterior anthelix fold to be reshaped.
 Only when pulling back the instrument the perichondrium is scratched on the front side of the concha along the reshaped anthelix fold.
 Optimum shape after complete wound healing, definitively fixed and secured also when using absorbable sutures.

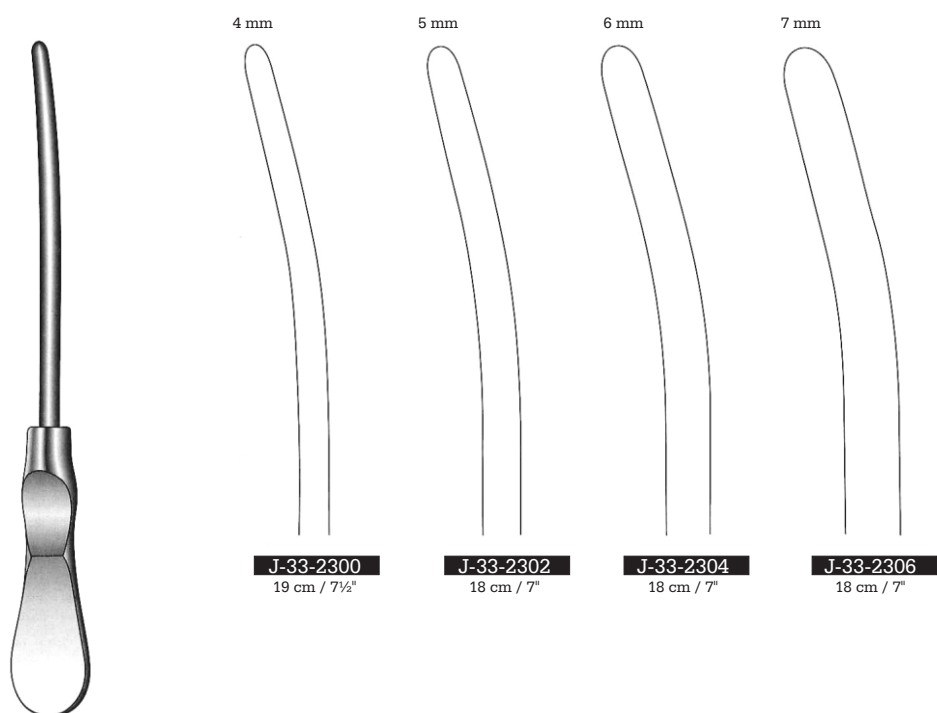
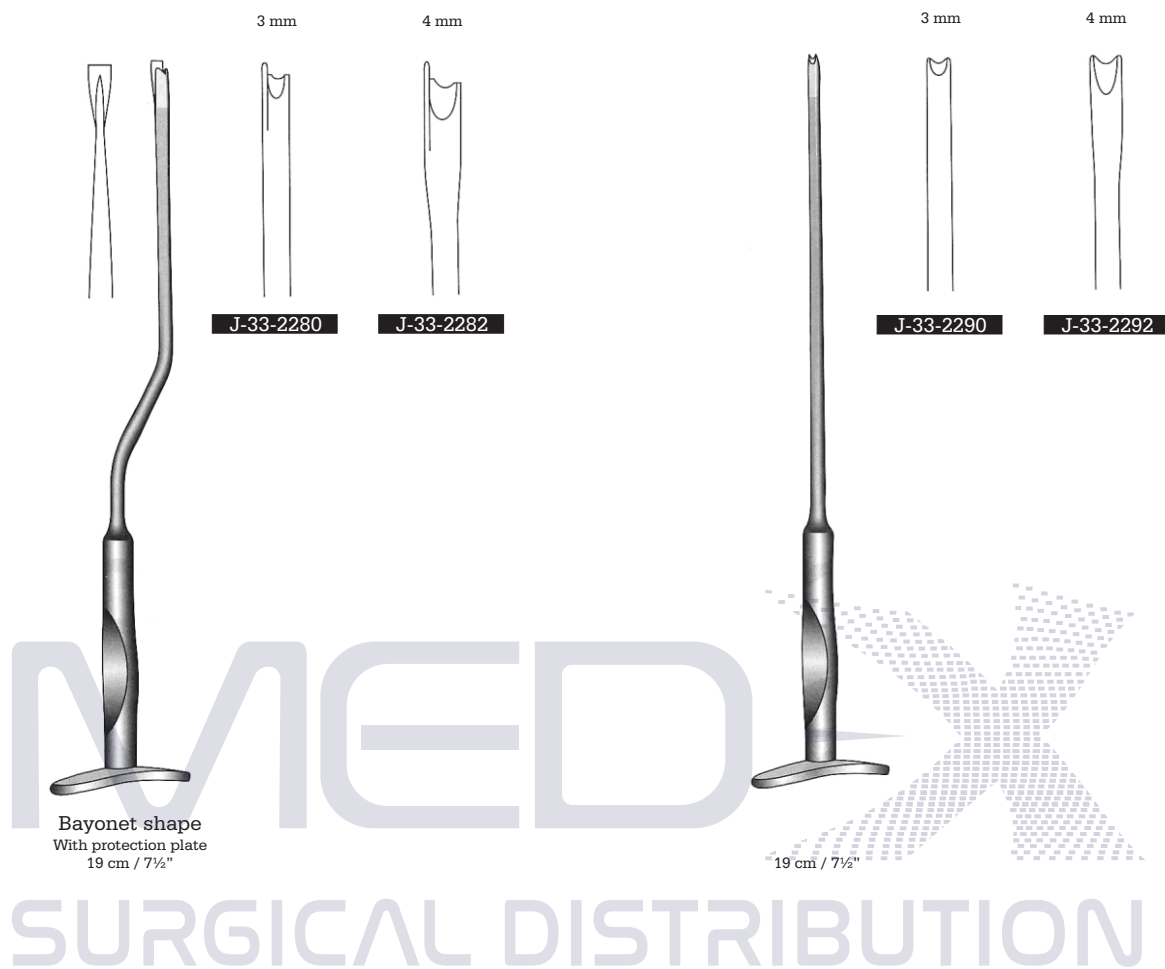

ENT & Plastic Surgery Instruments



Tonsil

Tonsil



Hurd
J-34-001
21 cm / 8¼"
For right hand

Hurd
J-34-005
21 cm / 8¼"
For left hand

Durham
J-34-020
25 cm / 10"

Durham
J-34-030
25 cm / 10"

Dupuy-Weiss
J-34-040
22 cm / 8¾"

Dupuy-Weiss
J-34-050
22 cm / 8¾"



Douglas
J-34-060
21 cm / 8¼"



Colver
J-34-070
22.5 cm / 9"

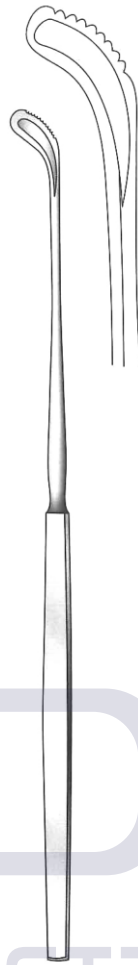

Fisher
J-34-080
22.5 cm / 9"

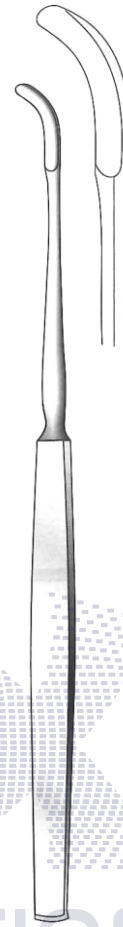

Day
J-34-090
21.5 cm / 8½"



Abraham
J-34-100
21.5 cm / 8½"



Canfield
J-34-110
21 cm / 8¼"



Tyding
J-34-120
21 cm / 8¼"

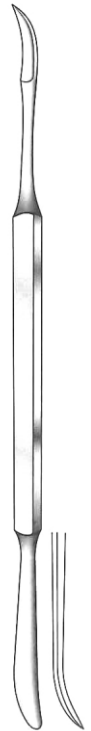

Lynch
J-34-130
20 cm / 8"

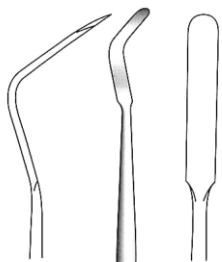

Carpenter
J-34-140
22.5 cm / 9"
4.4/8.8 mm

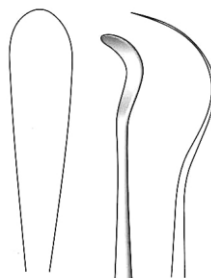

Carpenter
J-34-150
22.5 cm / 9"
4.4/8.8 mm

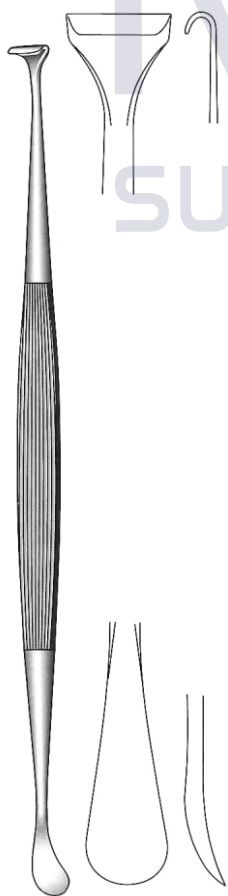

Hurd
J-34-151
23 cm / 9"
11/14 mm

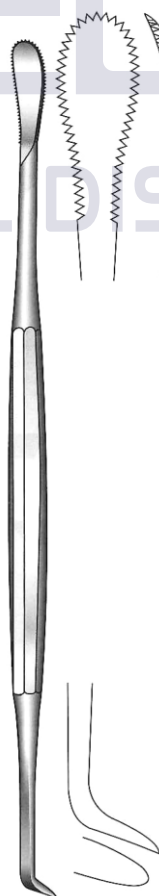

Henke
J-34-152
23 cm / 9"
10.5/5 mm

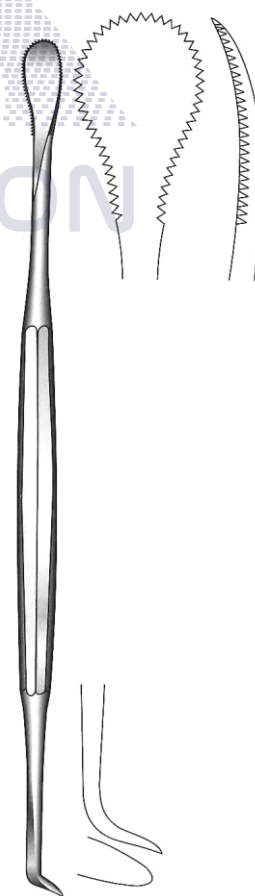

Henke
J-34-153
23 cm / 9"
16/5 mm

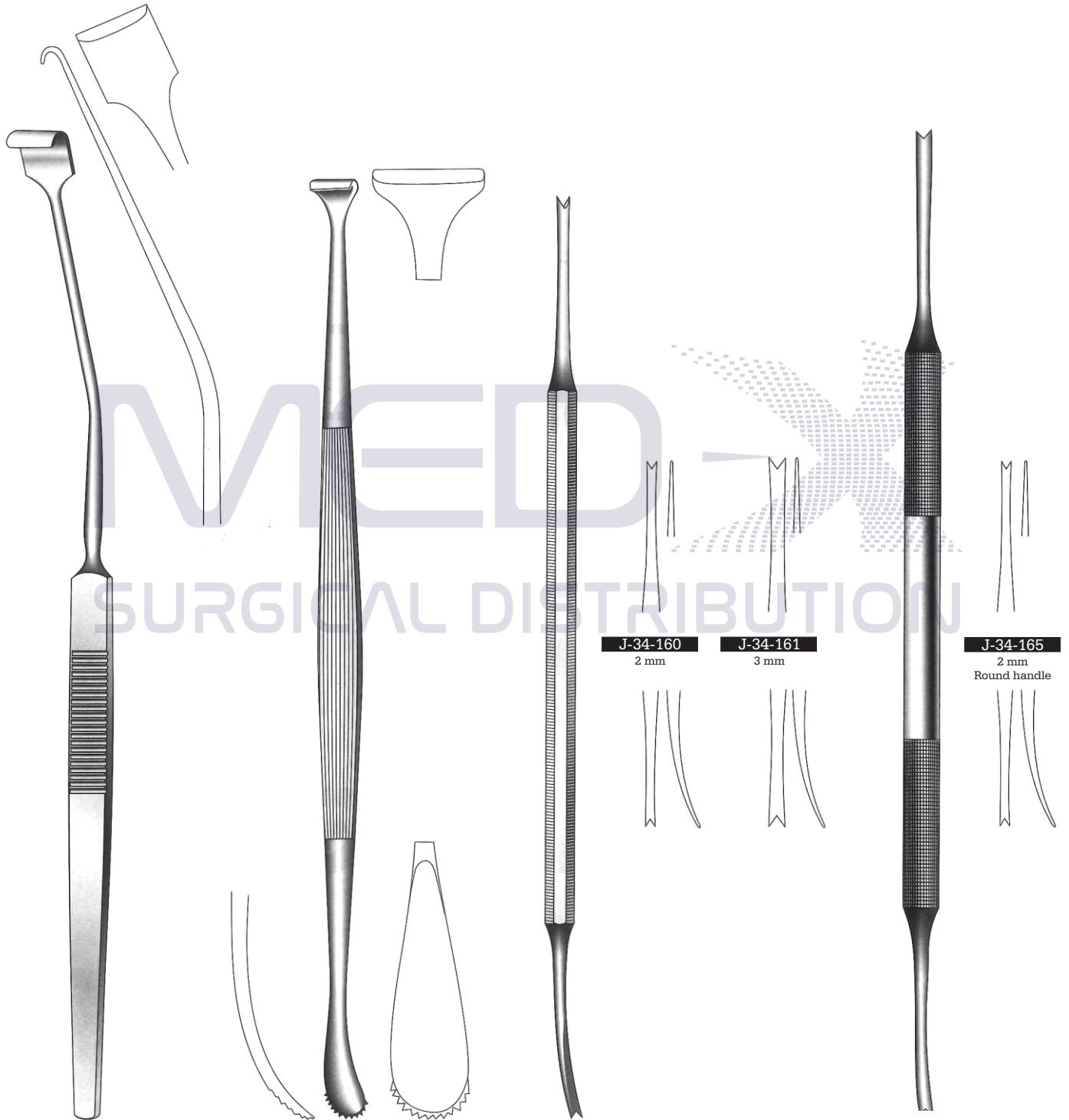

Nager
J-34-154
 24 cm / 9½"

Hurd
J-34-156
 22 cm / 8¾"
 10 x 12 mm wide
 Throat retractors and dissector

Luniatschek
 17.5 cm / 7"

J-34-160
 2 mm

J-34-161
 3 mm

J-34-165
 2 mm
 Round handle

Luniatschek
 17.5 cm / 7"

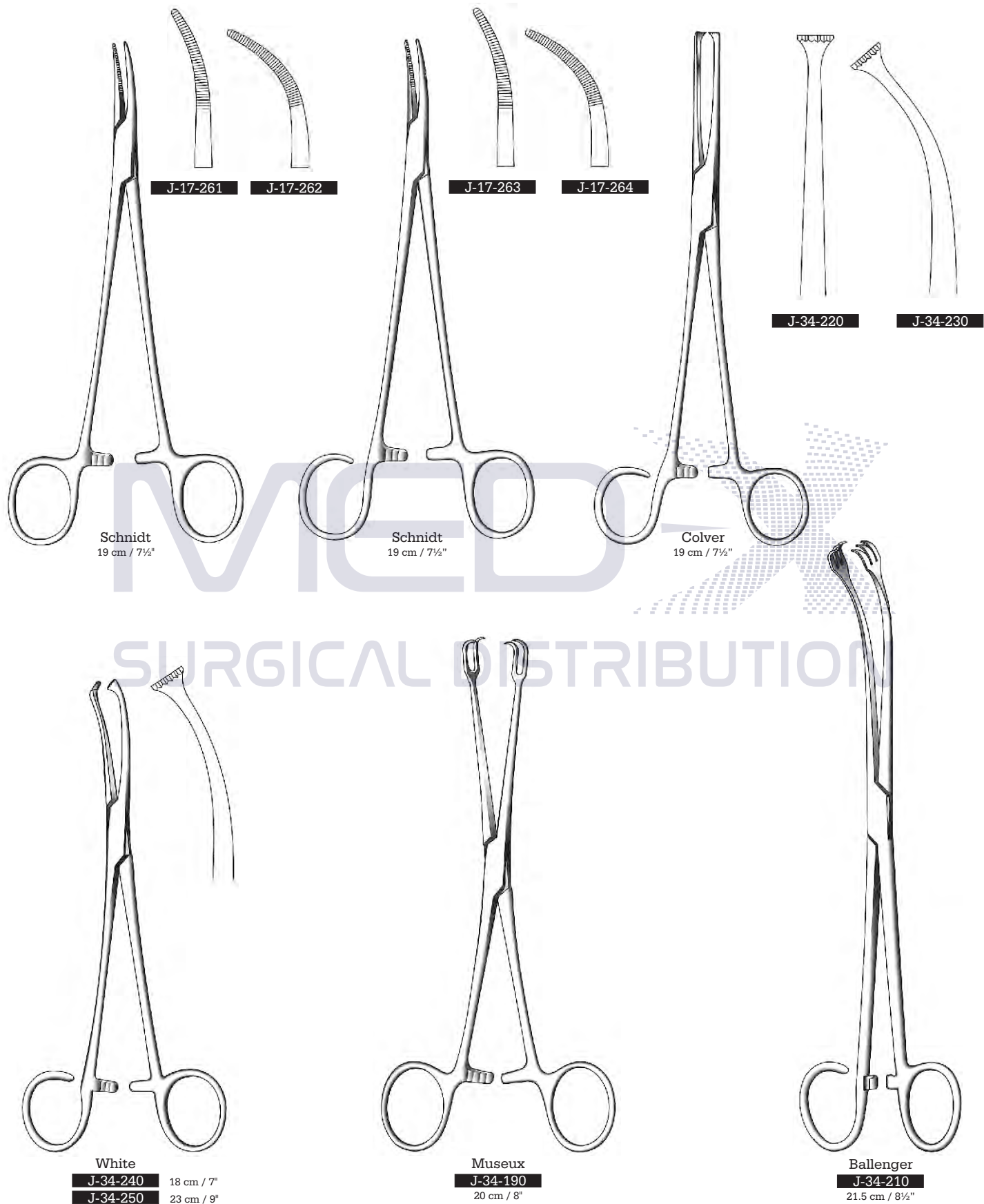

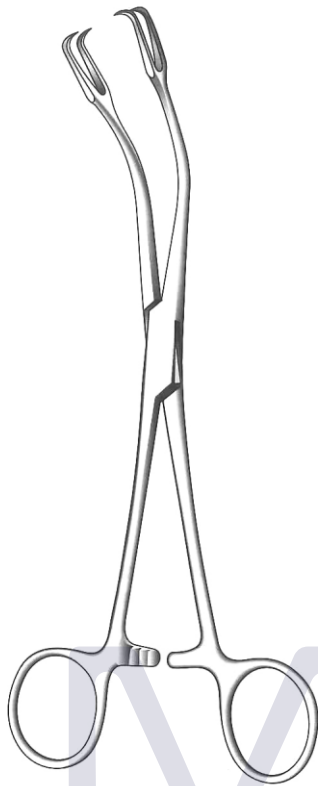

Museux
J-34-200
 20 cm / 8"

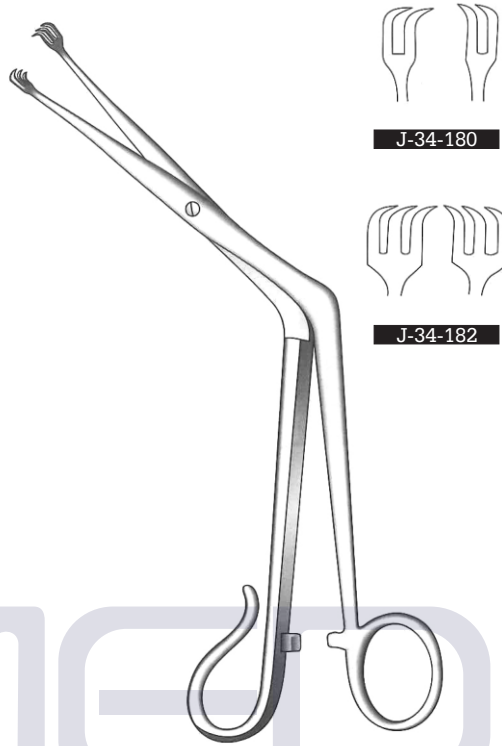

Tivnen-Tyding
 21 cm / 8 1/4"

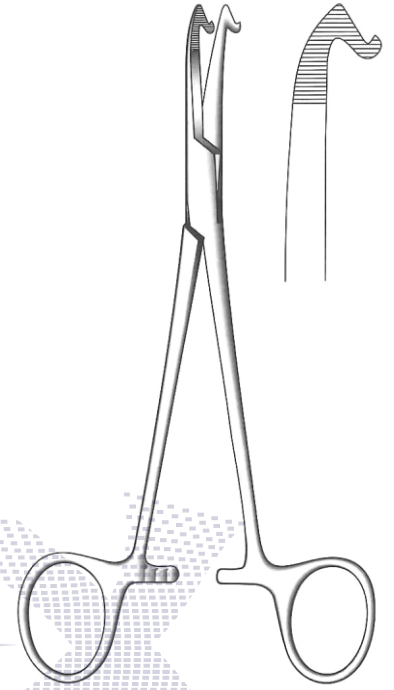

McWhorter-Lothrop
J-34-300
 18 cm / 7"



Blohmke
J-34-290
 20 cm / 8"

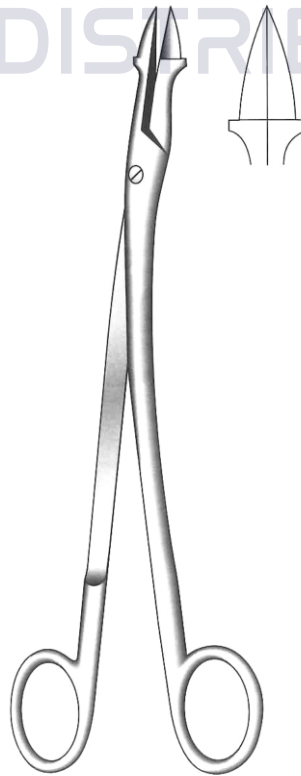

Thilenius
J-34-280
 20 cm / 8"

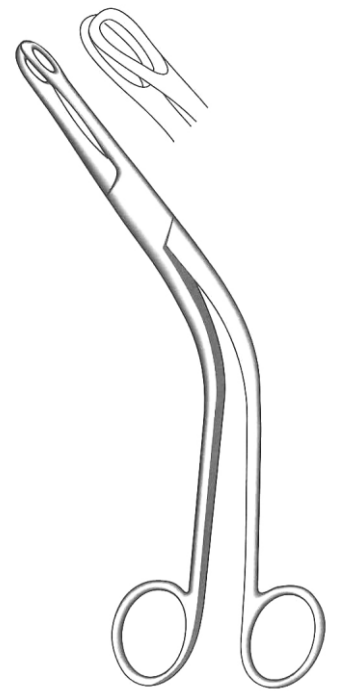

Denis-Browne
J-34-310
 18 cm / 7"



J-34-311
0.3 mm \varnothing

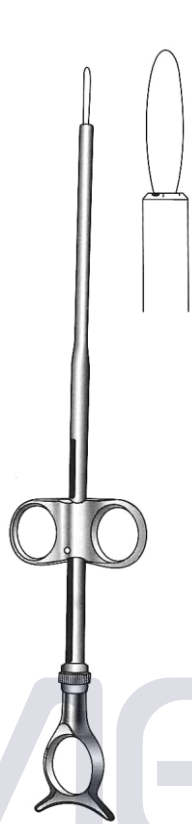

Eves
J-34-312
28 cm / 11"



Eves
J-34-313
28 cm / 11"

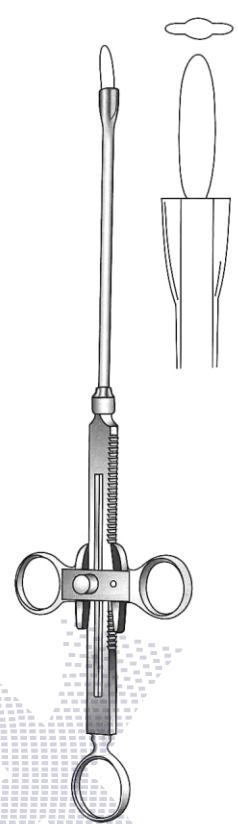

Bruenings
J-34-314
28 cm / 11"

MEDIX
SURGICAL DISTRIBUTION

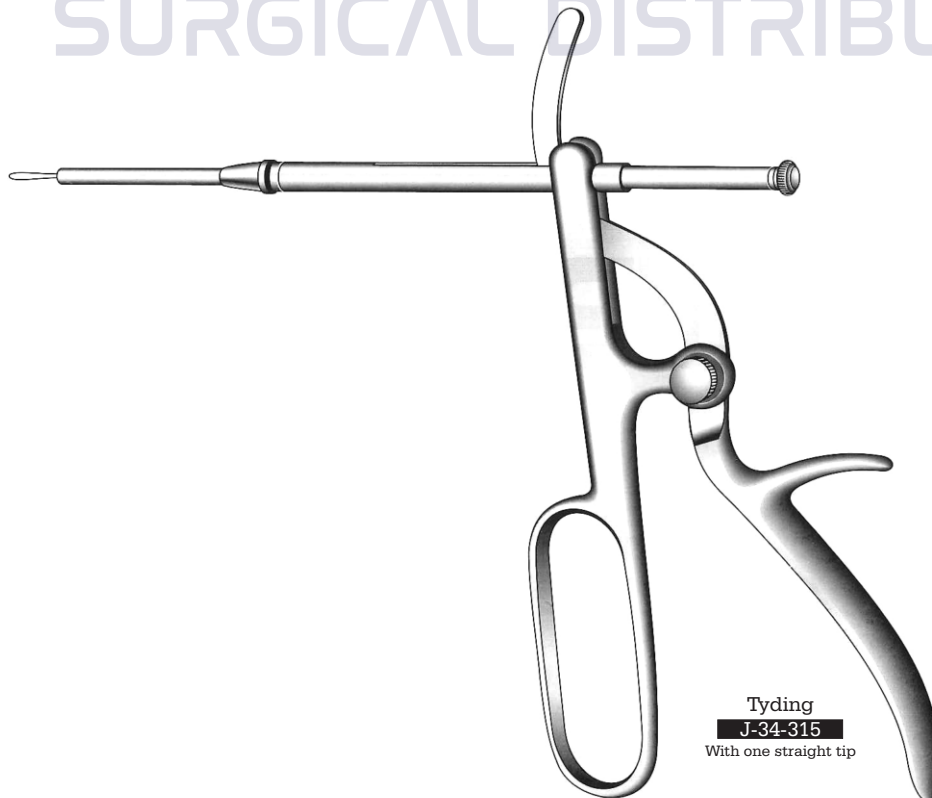

Tyding
J-34-315
With one straight tip

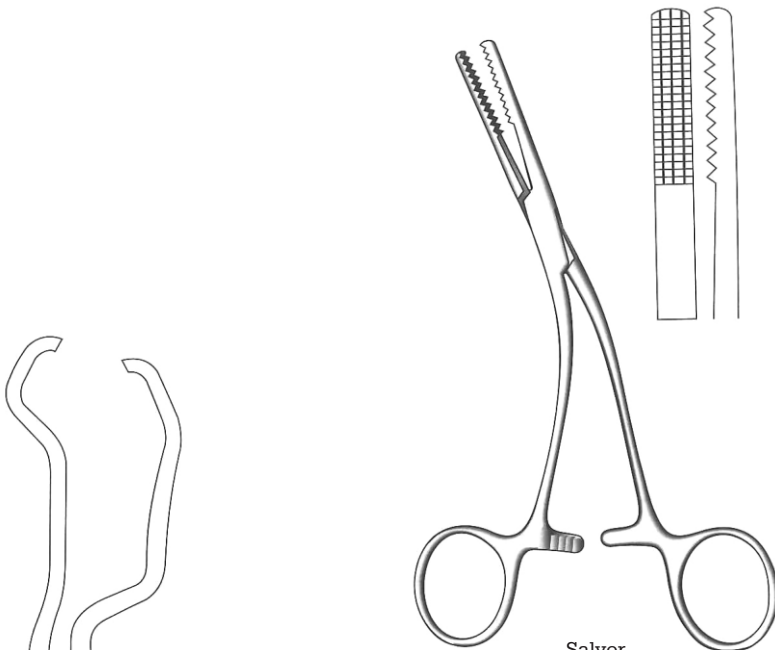

Salyer
J-34-1100
16 cm / 6½"

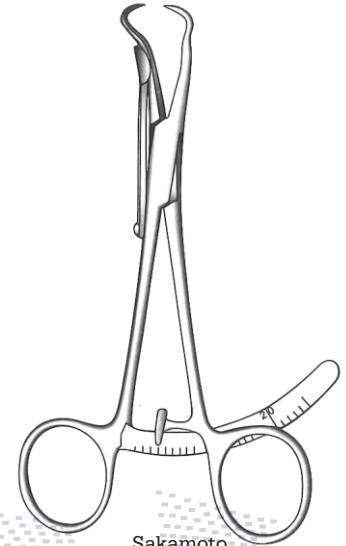

Sakamoto
J-34-1110
14 cm / 5½"
Measuring forceps

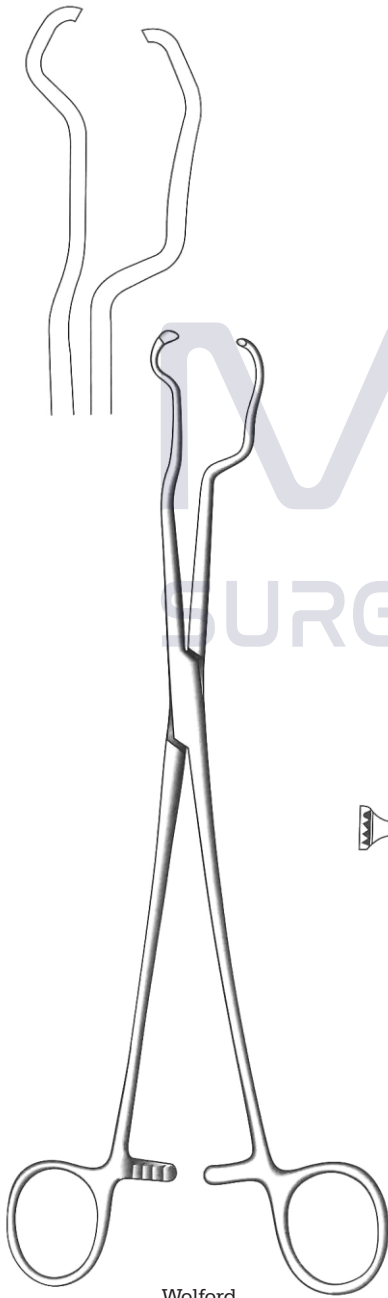

Wolford
J-34-1120
25 cm / 10"

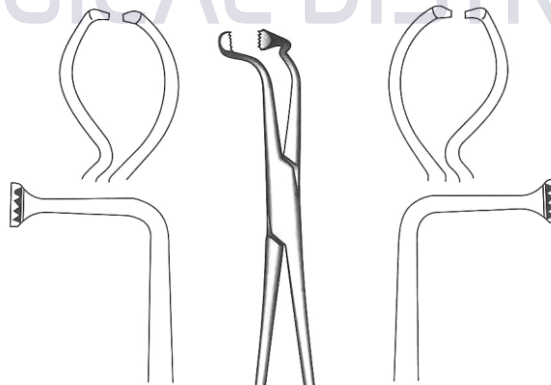

J-34-1130
Left

J-34-1132
Right

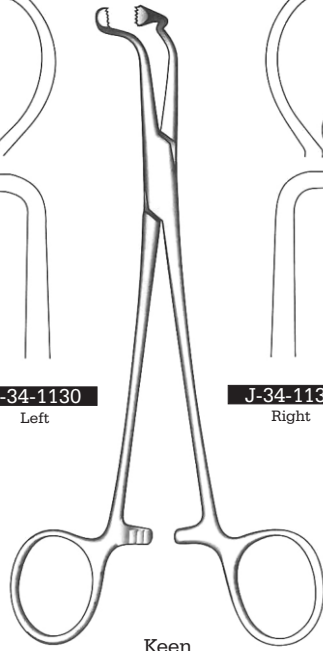

Keen
17.5 cm / 6¾"

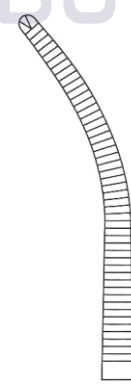

J-34-1140
19 cm / 7½"
1:2 Teeth
With chain

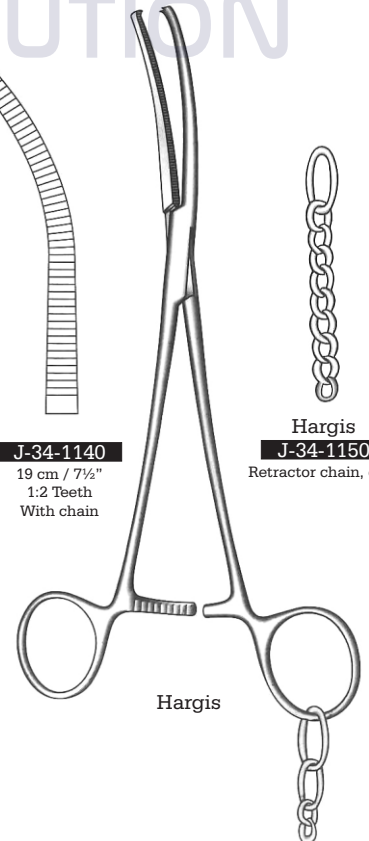

Hargis
J-34-1150
Retractor chain, only

Hargis

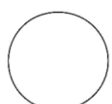

J-34-316
13 mm \varnothing
Cut
Through cut

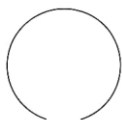

J-34-317
15 mm \varnothing
Cut
Through cut

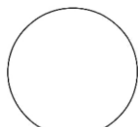

J-34-318
17 mm \varnothing
Cut
Through cut

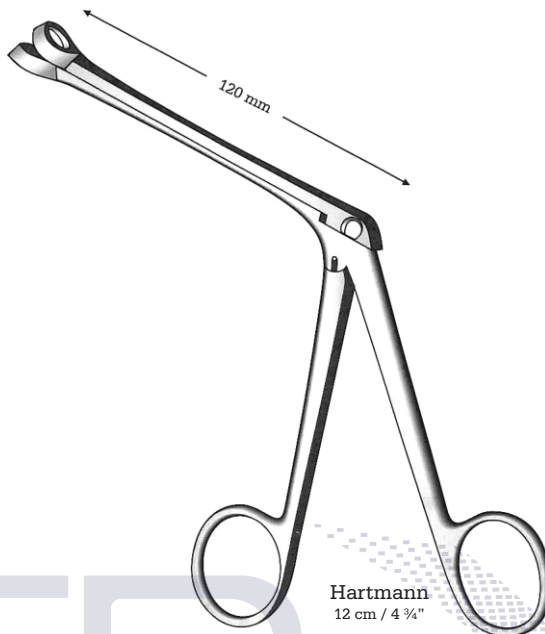

Hartmann
12 cm / 4 3/4"

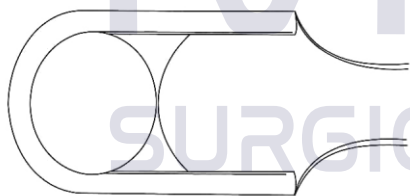

Fig. 1
J-34-319
Tip

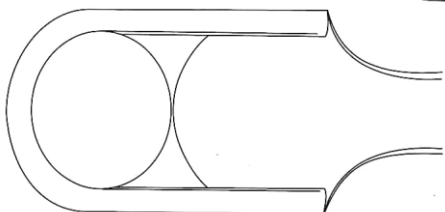

Fig. 2
J-34-320
Tip

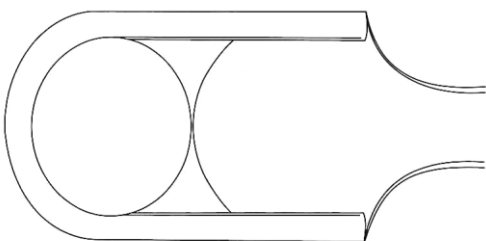
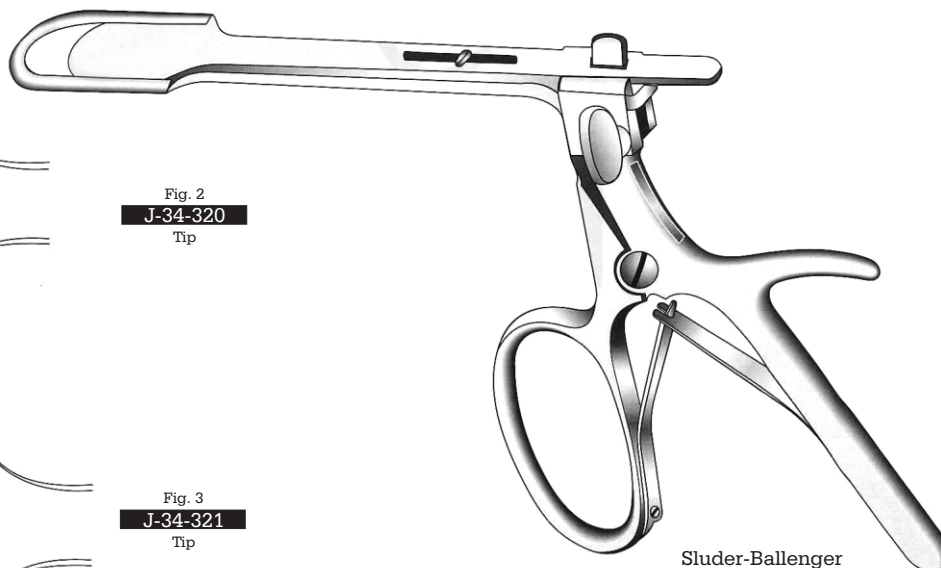
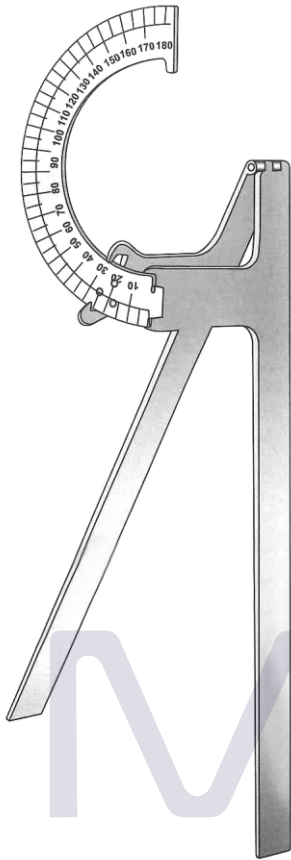

Fig. 3
J-34-321
Tip



Sluder-Ballenger
J-34-322
Complete set
with 3 tips



Möltgen
J-12-019
 24 cm / 9½"
 Fold up
 Flexometer

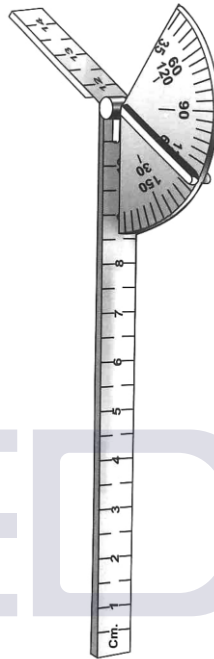

Jameson
J-12-070
 14 cm / 5½"
 Finger Goniometer

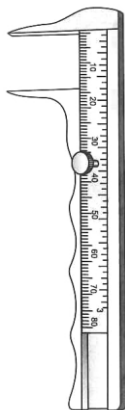

Jameson
J-12-051
 10 cm / 4"
 Calipers

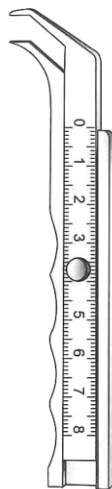

Thorpe
J-12-050
 11 cm / 4¾"



SD-2306-15 15 cm / 6"
SD-2306-20 20 cm / 8"
SD-2306-30 30 cm / 11¼"
SD-2306-50 50 cm / 19¼"
 Rulers (stainless steel)

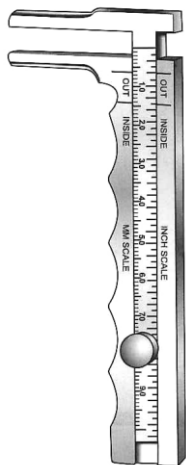

Townley
J-12-015
10 cm / 4"

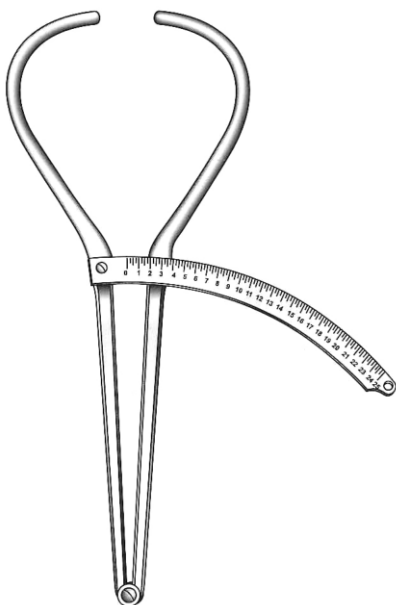

Bertillon
J-12-016

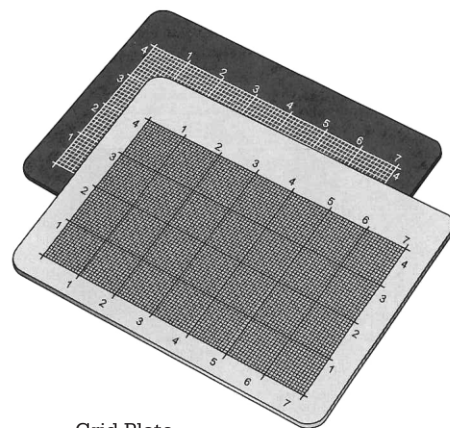

Grid Plate
J-12-101
J-12-102 Black Finish

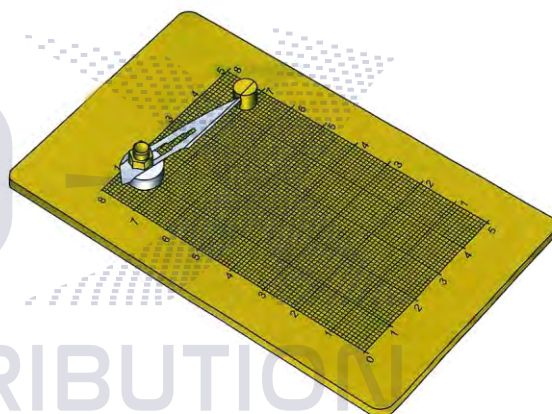

Grid Plate
J-12-103
With Blade
Gold Finish



Thole
J-12-018
34 cm / 13½"
Goniometer, Graduated in centimeter
For Internal and External measurement

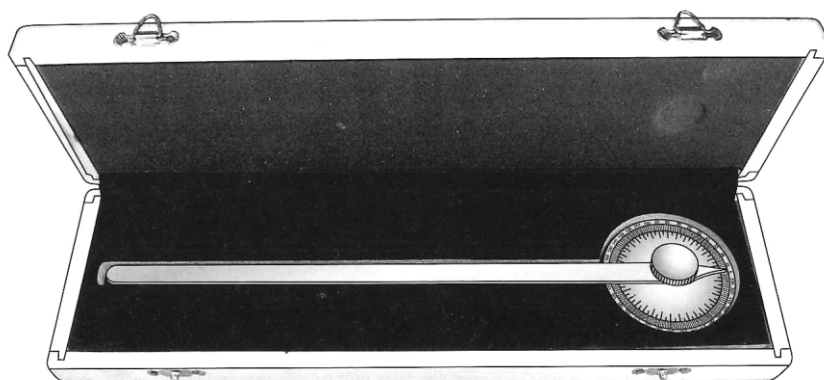

J-12-080
Goniometer

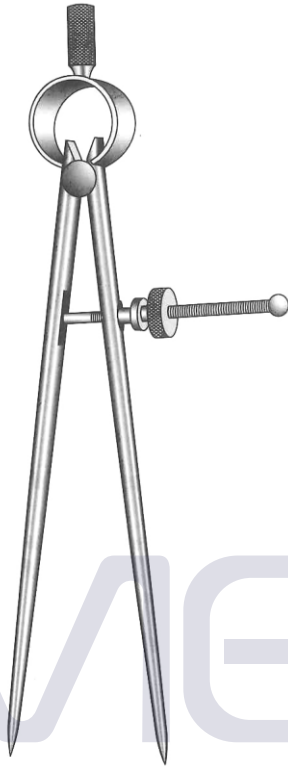

J-12-515
 19.5 cm / 7³/₄"
 Bone bow spacer

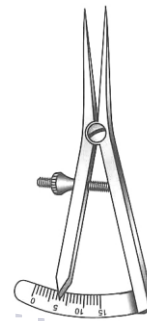

Castroviejo
J-12-017
 8 cm / 3¹/₄"
 Measuring range 15 mm

MED 
 SURGICAL DISTRIBUTION

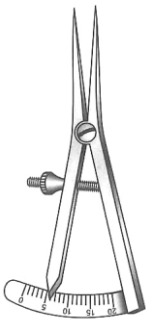

Castroviejo
J-12-060
 8 cm / 3¹/₄"
 Measuring range 20 mm

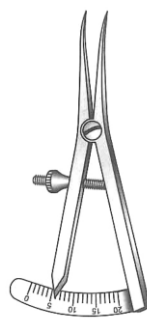

Castroviejo
J-12-061
 8 cm / 3¹/₄"
 Measuring range 20 mm
 Curved

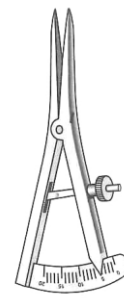

Castroviejo
J-12-520
 7 cm / 2³/₄"
 Measuring range 20 mm

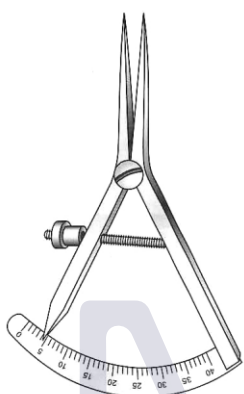

Castroviejo-Epker
J-12-062
9 cm / 3½"
Measuring range 40 mm

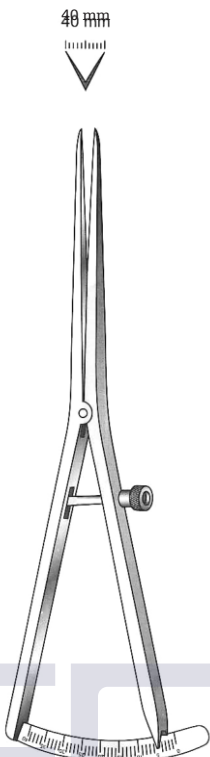

Castroviejo-Epker
J-12-063
18 cm / 7"
Measuring range 40 mm

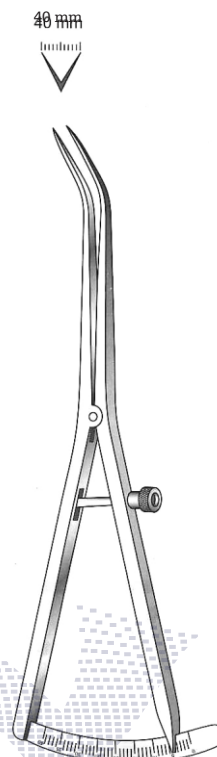

Castroviejo-Epker
J-12-069
18 cm / 7"
Measuring range 40 mm
Curved

SURGICAL DISTRIBUTION

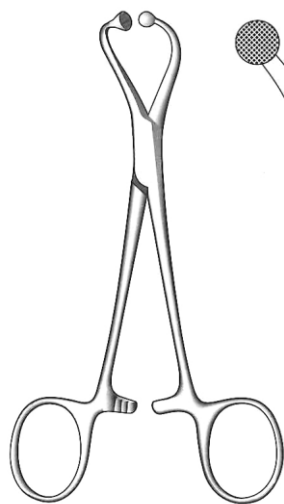

Ball-Socket

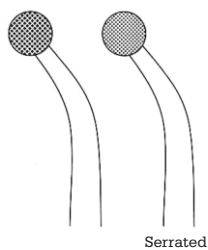

Serrated

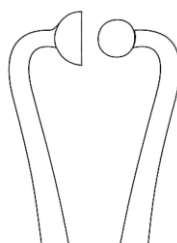

J-18-016

J-18-517

11 cm / 4½"

For paper cloths

Serrated

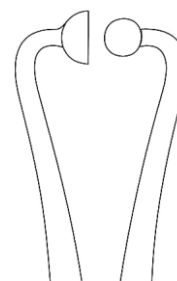

J-18-516

J-18-518

14 cm / 5½"

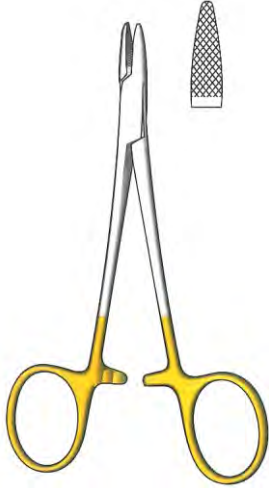

Obwegeser
JT-21-2500
 13 cm / 5 1/8"
 Wire Twister
 TC-Gold

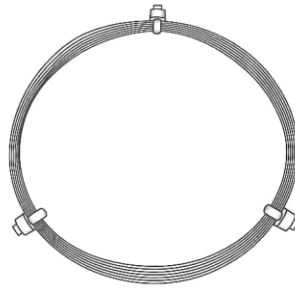

JO-21-5500
 Thickness of wire = 0.5 mm
 Bone Wire, Soft
 10 m, Roll

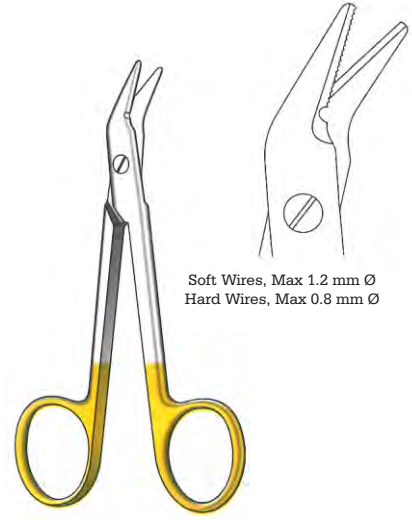

Soft Wires, Max 1.2 mm Ø
 Hard Wires, Max 0.8 mm Ø

JT-22-238
 12 cm / 4 3/4"
 Wire cutting scissors
 Serrated, Cutting Blade

MED 
 SURGICAL DISTRIBUTION

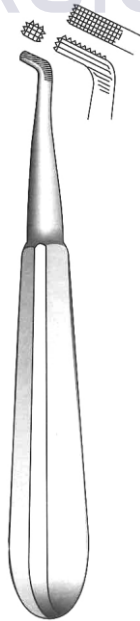

Mershon
J-32-2686
 15 cm / 6"

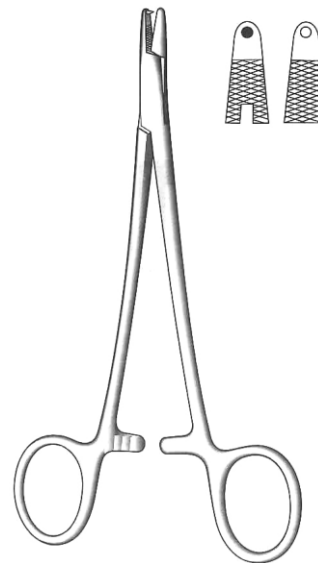

Obwegeser
JO-21-598
 15,5 cm / 6 1/4"
 Wire loop forceps

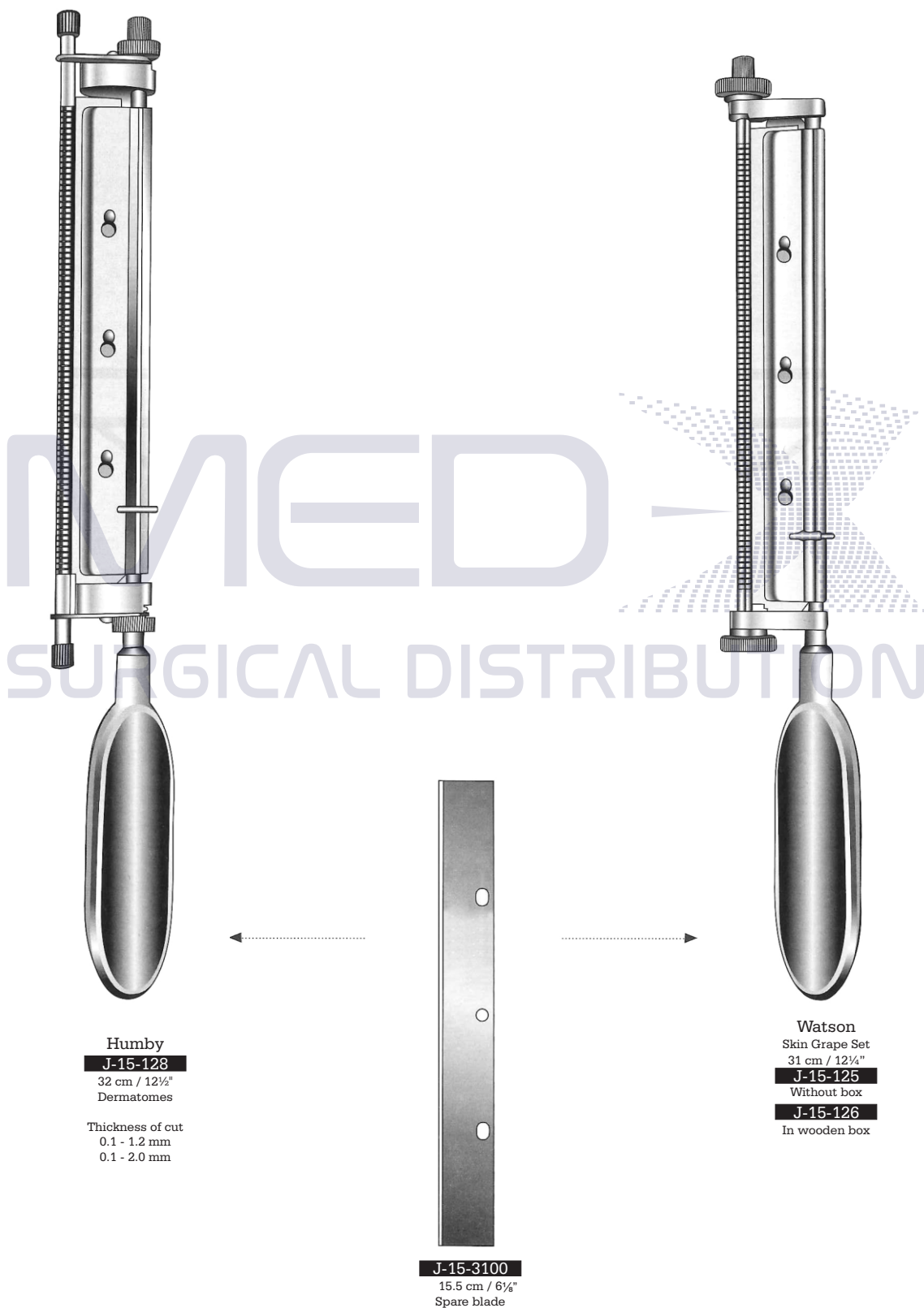

Humby
J-15-128
32 cm / 12½"
Dermatomes
Thickness of cut
0.1 - 1.2 mm
0.1 - 2.0 mm

J-15-3100
15.5 cm / 6¼"
Spare blade

Watson
Skin Grape Set
31 cm / 12¼"
J-15-125
Without box
J-15-126
In wooden box



Schink

30 cm / 12"

J-15-130

Dermatome, adjustable from 0.1 to 2.0 mm, complete with 1 interchangeable blade and 2 skin straightening blade

J-15-131

In Wooden box



Silver

19 cm / 7½"

J-15-145

J-15-146

In wooden box

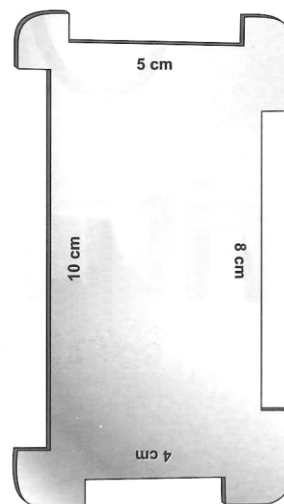

Schink

J-15-140

Skin straightening plate only



Schink

J-15-135

Spare blade only

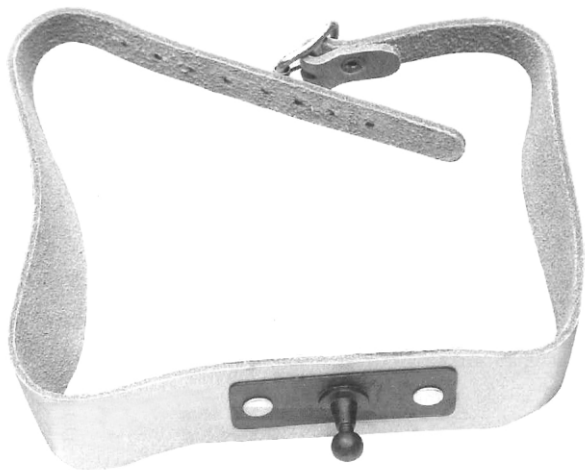

Head Band
J-12-302

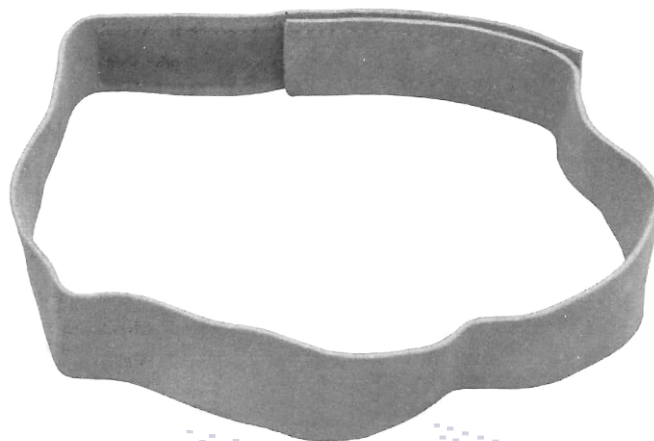

Head Band
J-12-304

MED
SURGICAL DISTRIBUTION

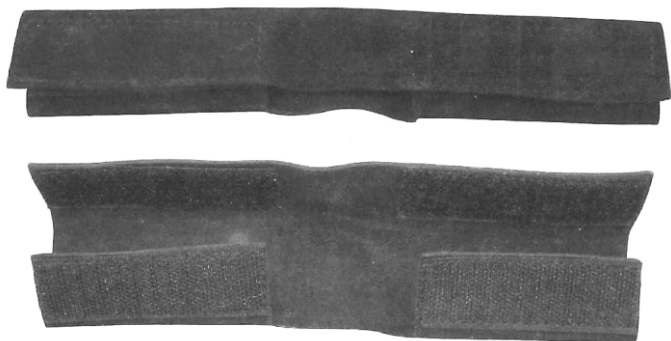

Head Band
J-12-306

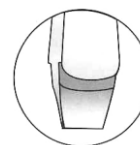

Blade holding forceps with screwdriver
Screwdriver for blade holding screw

J-15-320 11 cm / 4 1/4"
J-15-322 15.5 cm / 6"

ENT & Plastic Surgery
Instruments



Index
By Code

Index By Code

Index By Code

Item Code	Page	Item Code	Page	Item Code	Page	Item Code	Page
J-07-001	14	J-07-107	15	J-07-216	17	J-07-325	18
J-07-002	14	J-07-110	15, 45	J-07-217	17	J-07-326	18
J-07-003	14	J-07-111	15, 45	J-07-220	17	J-07-327	18
J-07-005	14	J-07-112	15, 45	J-07-221	17	J-07-330	19
J-07-006	14	J-07-115	15	J-07-222	17	J-07-331	19
J-07-007	14	J-07-116	15	J-07-225	17	J-07-332	19
J-07-010	14, 45	J-07-117	15	J-07-226	17	J-07-335	19
J-07-011	14, 45	J-07-120	16	J-07-227	17	J-07-336	19
J-07-012	14, 45	J-07-121	16	J-07-230	18	J-07-337	19
J-07-015	14	J-07-122	16	J-07-231	18	J-07-340	19
J-07-016	14	J-07-125	16	J-07-232	18	J-07-341	19
J-07-017	14	J-07-126	16	J-07-235	18	J-07-342	19
J-07-020	14, 45	J-07-127	16	J-07-236	18	J-07-345	19
J-07-021	14, 45	J-07-130	16	J-07-237	18	J-07-346	19
J-07-022	14, 45	J-07-131	16	J-07-240	18	J-07-347	19
J-07-025	14	J-07-132	16	J-07-241	18	J-07-350	19
J-07-026	14	J-07-135	16	J-07-242	18	J-07-351	19
J-07-027	14	J-07-136	16	J-07-245	18	J-07-352	19
J-07-030	14, 45	J-07-137	16	J-07-246	18	J-07-355	19
J-07-031	14, 45	J-07-140	16	J-07-247	18	J-07-356	19
J-07-032	14, 45	J-07-141	16	J-07-250	18	J-07-357	19
J-07-035	14	J-07-142	16	J-07-251	18	J-07-360	19
J-07-036	14	J-07-145	16	J-07-252	18	J-07-361	19
J-07-037	14	J-07-146	16	J-07-255	18	J-07-362	19
J-07-040	14	J-07-147	16	J-07-256	18	J-07-365	19
J-07-041	14	J-07-150	16	J-07-257	18	J-07-366	19
J-07-042	14	J-07-151	16	J-07-260	18	J-07-367	19
J-07-045	14	J-07-152	16	J-07-261	18	J-07-370	20
J-07-046	14	J-07-155	16	J-07-262	18	J-07-371	20
J-07-047	14	J-07-156	16	J-07-265	18	J-07-372	20
J-07-050	14	J-07-157	16	J-07-266	18	J-07-375	20
J-07-051	14	J-07-160	17	J-07-267	18	J-07-376	20
J-07-052	14	J-07-161	17	J-07-270	18	J-07-377	20
J-07-055	14	J-07-162	17	J-07-271	18	J-07-380	20
J-07-056	14	J-07-165	17	J-07-272	18	J-07-381	20
J-07-057	14	J-07-166	17	J-07-275	18	J-07-382	20
J-07-060	14	J-07-167	17	J-07-276	18	J-07-385	20
J-07-061	14	J-07-170	17	J-07-277	18	J-07-386	20
J-07-062	14	J-07-171	17	J-07-280	18	J-07-387	20
J-07-065	14	J-07-172	17	J-07-281	18	J-07-390	20
J-07-066	14	J-07-175	17	J-07-282	18	J-07-391	20
J-07-067	14	J-07-176	17	J-07-285	18	J-07-392	20
J-07-070	14	J-07-177	17	J-07-286	18	J-07-395	20
J-07-071	14	J-07-180	17	J-07-287	18	J-07-396	20
J-07-072	14	J-07-181	17	J-07-290	18	J-07-397	20
J-07-075	14	J-07-182	17	J-07-291	18	J-07-400	20
J-07-076	14	J-07-185	17	J-07-292	18	J-07-401	20
J-07-077	14	J-07-186	17	J-07-295	18	J-07-402	20
J-07-080	15	J-07-187	17	J-07-296	18	J-07-405	20
J-07-081	15	J-07-190	17	J-07-297	18	J-07-406	20
J-07-082	15	J-07-191	17	J-07-300	18	J-07-407	20
J-07-085	15	J-07-192	17	J-07-301	18	J-07-410	20
J-07-086	15	J-07-195	17	J-07-302	18	J-07-411	20
J-07-087	15	J-07-196	17	J-07-305	18	J-07-412	20
J-07-090	15, 45	J-07-197	17	J-07-306	18	J-07-415	20
J-07-091	15, 45	J-07-200	17	J-07-307	18	J-07-416	20
J-07-092	15, 45	J-07-201	17	J-07-310	18	J-07-417	20
J-07-095	15	J-07-202	17	J-07-311	18	J-07-420	20
J-07-096	15	J-07-205	17	J-07-312	18	J-07-421	20
J-07-097	15	J-07-206	17	J-07-315	18	J-07-422	20
J-07-100	15, 45	J-07-207	17	J-07-316	18	J-07-425	20
J-07-101	15, 45	J-07-210	17	J-07-317	18	J-07-426	20
J-07-102	15, 45	J-07-211	17	J-07-320	18	J-07-427	20
J-07-105	15	J-07-212	17	J-07-321	18	J-07-430	20
J-07-106	15	J-07-215	17	J-07-322	18	J-07-431	20

Item Code	Page	Item Code	Page	Item Code	Page	Item Code	Page
J-07-432	20	J-07-541	22	J-07-650	25	J-07-757	28
J-07-435	20	J-07-542	22	J-07-651	25	J-07-760	28
J-07-436	20	J-07-545	22	J-07-652	25	J-07-761	28
J-07-437	20	J-07-546	22	J-07-655	25	J-07-762	28
J-07-440	20	J-07-547	22	J-07-656	25	J-07-765	28
J-07-441	20	J-07-550	22	J-07-657	25	J-07-766	28
J-07-442	20	J-07-551	22	J-07-660	25	J-07-767	28
J-07-445	20	J-07-552	22	J-07-661	25	J-07-770	28
J-07-446	20	J-07-555	22	J-07-662	25	J-07-771	28
J-07-447	20	J-07-556	22	J-07-665	25	J-07-772	28
J-07-450	21	J-07-557	22	J-07-666	25	J-07-775	28
J-07-451	21	J-07-560	22	J-07-667	25	J-07-776	28
J-07-452	21	J-07-561	22	J-07-670	25	J-07-777	28
J-07-455	21	J-07-562	22	J-07-671	25	J-07-780	28
J-07-456	21	J-07-565	22	J-07-672	25	J-07-781	28
J-07-457	21	J-07-566	22	J-07-675	25	J-07-782	28
J-07-460	21	J-07-567	22	J-07-676	25	J-07-785	28
J-07-461	21	J-07-570	23	J-07-677	25	J-07-786	28
J-07-462	21	J-07-571	23	J-07-680	25	J-07-787	28
J-07-465	21	J-07-572	23	J-07-681	25	J-07-790	28
J-07-466	21	J-07-575	23	J-07-682	25	J-07-791	28
J-07-467	21	J-07-576	23	J-07-685	25	J-07-792	28
J-07-470	21	J-07-577	23	J-07-686	25	J-07-795	28
J-07-471	21	J-07-580	23	J-07-687	25	J-07-796	28
J-07-472	21	J-07-581	23	J-07-690	26	J-07-797	28
J-07-475	21	J-07-582	23	J-07-691	26	J-07-800	28
J-07-476	21	J-07-585	23	J-07-692	26	J-07-801	28
J-07-477	21	J-07-586	23	J-07-695	26	J-07-802	28
J-07-480	21	J-07-587	23	J-07-696	26	J-07-805	28
J-07-481	21	J-07-590	23	J-07-697	26	J-07-806	28
J-07-482	21	J-07-591	23	J-07-700	26	J-07-807	28
J-07-485	21	J-07-592	23	J-07-701	26	J-07-810	28
J-07-486	21	J-07-595	23	J-07-702	26	J-07-811	28
J-07-487	21	J-07-596	23	J-07-705	26	J-07-812	28
J-07-490	22	J-07-597	23	J-07-706	26	J-07-815	28
J-07-491	22	J-07-600	24	J-07-707	26	J-07-816	28
J-07-492	22	J-07-601	24	J-07-710	27	J-07-817	28
J-07-495	22	J-07-602	24	J-07-711	27	J-07-820	28
J-07-496	22	J-07-605	24	J-07-712	27	J-07-821	28
J-07-497	22	J-07-606	24	J-07-715	27	J-07-822	28
J-07-500	22	J-07-607	24	J-07-716	27	J-07-825	28
J-07-501	22	J-07-610	24	J-07-717	27	J-07-826	28
J-07-502	22	J-07-611	24	J-07-720	27	J-07-827	28
J-07-505	22	J-07-612	24	J-07-721	27	J-07-830	28
J-07-506	22	J-07-615	24	J-07-722	27	J-07-831	28
J-07-507	22	J-07-616	24	J-07-725	27	J-07-832	28
J-07-510	22	J-07-617	24	J-07-726	27	J-07-835	28
J-07-511	22	J-07-620	24	J-07-727	27	J-07-836	28
J-07-512	22	J-07-621	24	J-07-730	27	J-07-837	28
J-07-515	22	J-07-622	24	J-07-731	27	J-07-840	28
J-07-516	22	J-07-625	24	J-07-732	27	J-07-841	28
J-07-517	22	J-07-626	24	J-07-735	27	J-07-842	28
J-07-520	22	J-07-627	24	J-07-736	27	J-07-845	28
J-07-521	22	J-07-630	24	J-07-737	27	J-07-846	28
J-07-522	22	J-07-631	24	J-07-740	27	J-07-847	28
J-07-525	22	J-07-632	24	J-07-741	27	J-07-850	28
J-07-526	22	J-07-635	24	J-07-742	27	J-07-851	28
J-07-527	22	J-07-636	24	J-07-745	27	J-07-852	28
J-07-530	22	J-07-637	24	J-07-746	27	J-07-855	28
J-07-531	22	J-07-640	25	J-07-747	27	J-07-856	28
J-07-532	22	J-07-641	25	J-07-750	28	J-07-857	28
J-07-535	22	J-07-642	25	J-07-751	28	J-07-860	28
J-07-536	22	J-07-645	25	J-07-752	28	J-07-861	28
J-07-537	22	J-07-646	25	J-07-755	28	J-07-862	28
J-07-540	22	J-07-647	25	J-07-756	28	J-07-865	28

Item Code	Page	Item Code	Page	Item Code	Page	Item Code	Page
J-07-866	28	J-07-975	29	J-07-1210	32	J-07-1377	36
J-07-867	28	J-07-976	29	J-07-1211	32	J-07-1380	36
J-07-870	28	J-07-977	29	J-07-1212	32	J-07-1381	36
J-07-871	28	J-07-980	29	J-07-1220	33	J-07-1382	36
J-07-872	28	J-07-981	29	J-07-1221	33	J-07-1385	36
J-07-875	28	J-07-982	29	J-07-1222	33	J-07-1386	36
J-07-876	28	J-07-985	29	J-07-1230	33	J-07-1387	36
J-07-877	28	J-07-986	29	J-07-1231	33	J-07-1390	36
J-07-880	28	J-07-987	29	J-07-1232	33	J-07-1391	36
J-07-881	28	J-07-1000	30	J-07-1240	33	J-07-1392	36
J-07-882	28	J-07-1001	30	J-07-1241	33	J-07-1395	36
J-07-885	28	J-07-1002	30	J-07-1242	33	J-07-1396	36
J-07-886	28	J-07-1010	30	J-07-1250	33	J-07-1397	36
J-07-887	28	J-07-1011	30	J-07-1251	33	J-07-1400	37
J-07-890	29	J-07-1012	30	J-07-1252	33	J-07-1401	37
J-07-891	29	J-07-1020	30	J-07-1260	34	J-07-1402	37
J-07-892	29	J-07-1030	30	J-07-1261	34	J-07-1410	37
J-07-895	29	J-07-1040	30	J-07-1262	34	J-07-1411	37
J-07-896	29	J-07-1050	30	J-07-1265	34	J-07-1412	37
J-07-897	29	J-07-1060	30, 46	J-07-1266	34	J-07-1420	37
J-07-900	29	J-07-1070	30	J-07-1267	34	J-07-1421	37
J-07-901	29	J-07-1071	30	J-07-1270	34	J-07-1422	37
J-07-902	29	J-07-1072	30	J-07-1271	34	J-07-1430	37
J-07-905	29	J-07-1075	30	J-07-1272	34	J-07-1431	37
J-07-906	29	J-07-1076	30	J-07-1275	34	J-07-1432	37
J-07-907	29	J-07-1077	30	J-07-1276	34	J-07-1440	38
J-07-910	29	J-07-1080	31	J-07-1277	34	J-07-1441	38
J-07-911	29	J-07-1081	31	J-07-1280	35	J-07-1442	38
J-07-912	29	J-07-1082	31	J-07-1281	35	J-07-1445	38
J-07-915	29	J-07-1090	31	J-07-1282	35	J-07-1446	38
J-07-916	29	J-07-1091	31	J-07-1290	35	J-07-1447	38
J-07-917	29	J-07-1092	31	J-07-1291	35	J-07-1450	38
J-07-920	29	J-07-1100	31	J-07-1292	35	J-07-1451	38
J-07-921	29	J-07-1101	31	J-07-1300	35	J-07-1452	38
J-07-922	29	J-07-1102	31	J-07-1301	35	J-07-1455	38
J-07-925	29	J-07-1110	31	J-07-1302	35	J-07-1456	38
J-07-926	29	J-07-1111	31	J-07-1310	35	J-07-1457	38
J-07-927	29	J-07-1112	31	J-07-1311	35	J-07-1460	38
J-07-930	29	J-07-1120	31	J-07-1312	35	J-07-1461	38
J-07-931	29	J-07-1121	31	J-07-1320	35	J-07-1462	38
J-07-932	29	J-07-1122	31	J-07-1321	35	J-07-1465	38
J-07-935	29	J-07-1130	31	J-07-1322	35	J-07-1466	38
J-07-936	29	J-07-1131	31	J-07-1330	35	J-07-1467	38
J-07-937	29	J-07-1132	31	J-07-1331	35	J-07-1470	38
J-07-940	29	J-07-1140	32	J-07-1332	35	J-07-1471	38
J-07-941	29	J-07-1141	32	J-07-1340	35	J-07-1472	38
J-07-942	29	J-07-1142	32	J-07-1341	35	J-07-1475	38
J-07-945	29	J-07-1150	32	J-07-1342	35	J-07-1476	38
J-07-946	29	J-07-1151	32	J-07-1350	36	J-07-1477	38
J-07-947	29	J-07-1152	32	J-07-1351	36	J-07-1480	39
J-07-950	29	J-07-1160	32	J-07-1352	36	J-07-1481	39
J-07-951	29	J-07-1161	32	J-07-1355	36	J-07-1482	39
J-07-952	29	J-07-1162	32	J-07-1356	36	J-07-1490	39
J-07-955	29	J-07-1170	32	J-07-1357	36	J-07-1491	39
J-07-956	29	J-07-1171	32	J-07-1360	36	J-07-1492	39
J-07-957	29	J-07-1172	32	J-07-1361	36	J-07-1500	39
J-07-960	29	J-07-1180	32	J-07-1362	36	J-07-1501	39
J-07-961	29	J-07-1181	32	J-07-1365	36	J-07-1502	39
J-07-962	29	J-07-1182	32	J-07-1366	36	J-07-1510	39
J-07-965	29	J-07-1190	32	J-07-1367	36	J-07-1511	39
J-07-966	29	J-07-1191	32	J-07-1370	36	J-07-1512	39
J-07-967	29	J-07-1192	32	J-07-1371	36	J-07-1520	40
J-07-970	29	J-07-1200	32	J-07-1372	36	J-07-1521	40
J-07-971	29	J-07-1201	32	J-07-1375	36	J-07-1522	40
J-07-972	29	J-07-1202	32	J-07-1376	36	J-07-1530	40

Item Code	Page	Item Code	Page	Item Code	Page	Item Code	Page
J-07-1531	40	J-07-1785	43	J-07-2022	46	J-14-073	12
J-07-1532	40	J-07-1786	43	J-07-2030	47	J-14-074	12
J-07-1535	40	J-07-1787	43	J-07-2031	47	J-14-075	12
J-07-1536	40	J-07-1790	43	J-07-2032	47	J-14-076	12
J-07-1537	40	J-07-1791	43	J-07-2033	47	J-14-130	11
J-07-1540	40	J-07-1792	43	J-07-2034	47	J-14-131	11
J-07-1541	40	J-07-1795	43	J-07-2040	48	J-14-132	11
J-07-1542	40	J-07-1796	43	J-07-2041	48	J-14-133	11
J-07-1545	40	J-07-1797	43	J-07-2042	48	J-14-134	11
J-07-1546	40	J-07-1800	43	J-07-2050	47	J-14-135	11
J-07-1547	40	J-07-1801	43	J-07-2051	47	J-14-136	11
J-07-1550	40	J-07-1802	43	J-07-2052	47	J-14-137	11
J-07-1551	40	J-07-1805	43	J-12-015	340	J-14-138	11
J-07-1552	40	J-07-1806	43	J-12-016	340	J-14-140	11
J-07-1560	40	J-07-1807	43	J-12-017	341	J-14-141	11
J-07-1561	40	J-07-1810	43	J-12-018	340	J-14-142	11
J-07-1562	40	J-07-1811	43	J-12-019	339	J-14-143	11
J-07-1570	40	J-07-1812	43	J-12-050	339	J-14-144	11
J-07-1571	40	J-07-1815	43	J-12-051	339	J-14-145	11
J-07-1572	40	J-07-1816	43	J-12-060	341	J-14-146	11
J-07-1610	45	J-07-1817	43	J-12-061	341	J-14-147	11
J-07-1611	45	J-07-1820	43	J-12-062	342	J-14-148	11
J-07-1612	45	J-07-1821	43	J-12-063	342	J-14-150	11
J-07-1630	45	J-07-1822	43	J-12-069	342	J-14-151	11
J-07-1631	45	J-07-1830	43	J-12-070	339	J-14-152	11
J-07-1632	45	J-07-1831	43	J-12-080	340	J-14-153	11
J-07-1660	45	J-07-1832	43	J-12-101	340	J-14-160	11
J-07-1661	45	J-07-1835	43	J-12-102	340	J-14-161	11
J-07-1662	45	J-07-1836	43	J-12-103	340	J-14-162	11
J-07-1670	45	J-07-1837	43	J-12-302	346	J-14-163	11
J-07-1671	45	J-07-1840	43	J-12-304	346	J-14-164	11
J-07-1672	45	J-07-1841	43	J-12-306	346	J-14-165	11
J-07-1680	45	J-07-1842	43	J-12-515	341	J-14-170	11
J-07-1681	45	J-07-1850	44	J-12-520	341	J-14-171	11
J-07-1682	45	J-07-1851	44	J-14-041	10	J-14-172	11
J-07-1690	45	J-07-1852	44	J-14-042	10	J-14-180	11
J-07-1691	45	J-07-1955	44	J-14-043	10	J-14-185	11
J-07-1692	45	J-07-1956	44	J-14-044	10	J-14-190	11
J-07-1700	41	J-07-1957	44	J-14-045	10	J-14-250	10
J-07-1701	41	J-07-1960	44	J-14-046	10	J-14-251	10
J-07-1702	41	J-07-1961	44	J-14-047	10	J-14-252	10
J-07-1710	41, 45	J-07-1962	44	J-14-048	10	J-14-253	10
J-07-1711	41, 45	J-07-1965	44	J-14-049	10	J-14-254	10
J-07-1712	41, 45	J-07-1966	44	J-14-050	10	J-14-260	10
J-07-1720	42, 45	J-07-1967	44	J-14-051	10	J-14-315	12
J-07-1721	42, 45	J-07-1970	44	J-14-052	10	J-14-330	12
J-07-1722	42, 45	J-07-1971	44	J-14-053	10	J-14-331	12
J-07-1730	42, 45	J-07-1972	44	J-14-054	10	J-14-332	12
J-07-1731	42, 45	J-07-1975	44	J-14-055	10	J-14-333	12
J-07-1732	42, 45	J-07-1976	44	J-14-057	10	J-14-334	12
J-07-1740	42, 45	J-07-1977	44	J-14-058	10	J-15-063	2
J-07-1741	42, 45	J-07-1980	44	J-14-059	12	J-15-064	2
J-07-1742	42, 45	J-07-1981	44	J-14-060	12	J-15-065	2
J-07-1750	42, 45	J-07-1982	44	J-14-061	12	J-15-066	2
J-07-1751	42, 45	J-07-1985	44	J-14-062	12	J-15-067	3
J-07-1752	42, 45	J-07-1986	44	J-14-063	12	J-15-068	3
J-07-1760	43	J-07-1987	44	J-14-064	12	J-15-069	3
J-07-1761	43	J-07-1990	44	J-14-065	12	J-15-070	3
J-07-1762	43	J-07-1991	44	J-14-066	12	J-15-071	4
J-07-1770	43	J-07-1992	44	J-14-067	12	J-15-072	4
J-07-1771	43	J-07-2000	44	J-14-068	12	J-15-073	4
J-07-1772	43	J-07-2001	44	J-14-069	12	J-15-074	4
J-07-1780	43	J-07-2002	44	J-14-070	12	J-15-075	4
J-07-1781	43	J-07-2010	46	J-14-071	12	J-15-076	5
J-07-1782	43	J-07-2020	46	J-14-072	12	J-15-077	5

Item Code	Page	Item Code	Page	Item Code	Page	Item Code	Page
J-15-078	5	J-16-740	101	J-17-017	125	J-17-2088	126
J-15-085	6	J-16-755	102	J-17-018	125	J-18-016	342
J-15-086	6	J-16-780	103	J-17-019	125	J-18-170	206
J-15-087	6	J-16-800	104	J-17-020	125	J-18-516	342
J-15-088	6	J-16-805	104	J-17-021	125	J-18-517	342
J-15-100	3	J-16-810	104	J-17-022	125	J-18-518	342
J-15-105	4	J-16-815	104	J-17-023	125	J-19-001	143
J-15-125	344	J-16-820	104	J-17-024	125	J-19-002	143
J-15-126	344	J-16-825	104	J-17-025	125	J-19-040	144
J-15-128	344	J-16-830	104	J-17-026	125	J-19-041	144
J-15-130	345	J-16-835	104	J-17-027	125	J-19-044	144
J-15-131	345	J-16-850	105	J-17-028	125	J-19-047	144
J-15-135	345	J-16-851	105	J-17-033	125	J-19-071	138
J-15-140	345	J-16-854	105	J-17-034	125	J-19-072	138
J-15-145	345	J-16-855	105	J-17-035	125	J-19-073	138
J-15-146	345	J-16-858	105	J-17-036	125	J-19-074	138
J-15-150	6	J-16-859	105	J-17-037	125	J-19-075	138
J-15-225	8	J-16-860	105	J-17-038	125	J-19-076	138
J-15-231	8	J-16-861	105	J-17-039	125	J-19-084	137
J-15-232	8	J-16-864	105	J-17-040	125	J-19-085	137
J-15-305	7	J-16-865	105	J-17-041	125	J-19-086	153
J-15-311	7	J-16-868	105	J-17-042	125	J-19-087	153
J-15-320	346	J-16-869	105	J-17-057	126	J-19-088	153
J-15-321	7	J-16-880	105	J-17-058	126	J-19-089	153
J-15-322	346	J-16-881	105	J-17-059	126	J-19-090	153
J-15-326	8	J-16-884	105	J-17-060	126	J-19-091	153
J-15-327	8	J-16-885	105	J-17-261	334	J-19-114	146
J-15-350	8	J-16-888	105	J-17-262	334	J-19-115	147
J-15-352	8	J-16-889	105	J-17-263	334	J-19-116	147
J-15-355	8	J-16-1000	105	J-17-264	334	J-19-117	146
J-15-3100	344	J-16-1001	105	J-17-500	125	J-19-118	146
J-16-078	100	J-16-1004	105	J-17-502	125	J-19-119	147
J-16-079	100	J-16-1005	105	J-17-506	125	J-19-120	147
J-16-082	103	J-16-1008	105	J-17-508	125	J-19-121	147
J-16-083	103	J-16-1009	105	J-17-512	125	J-19-122	147
J-16-085	103	J-16-1021	106	J-17-514	125	J-19-123	147
J-16-086	102	J-16-1022	106	J-17-518	125	J-19-124	147
J-16-086A	102	J-16-1025	106	J-17-520	125	J-19-163	151
J-16-087	102	J-16-1026	106	J-17-550	126	J-19-165	151
J-16-087A	102	J-16-1030	106	J-17-551	126	J-19-167	151
J-16-088	102	J-16-1031	106	J-17-560	126	J-19-169	151
J-16-089	102	J-16-1041	106	J-17-561	126	J-19-171	151
J-16-089A	102	J-16-1042	106	J-17-562	126	J-19-234	144
J-16-089B	102	J-16-1044	106	J-17-563	126	J-19-235	144
J-16-111	103	J-16-1045	106	J-17-2000	124	J-19-236	144
J-16-113	107	J-16-1048	106	J-17-2002	124	J-19-252	160
J-16-128	101	J-16-1049	106	J-17-2004	124	J-19-253	161
J-16-128S	101	J-16-1060	106	J-17-2010	124	J-19-254	161
J-16-129	101	J-16-1061	106	J-17-2012	124	J-19-255	161
J-16-129S	101	J-16-1064	106	J-17-2014	124	J-19-256	161
J-16-130	102	J-16-1065	106	J-17-2021	124	J-19-258	161
J-16-130B	102	J-16-1068	106	J-17-2022	124	J-19-259	160
J-16-130C	102	J-16-1069	106	J-17-2030	124	J-19-260	160
J-16-187	103	J-16-1080	106	J-17-2032	124	J-19-262	160
J-16-190	103	J-16-1090	107	J-17-2036	124	J-19-263	160
J-16-192	103	J-16-1101	107	J-17-2038	124	J-19-266	161
J-16-282	103	J-16-1111	107	J-17-2040	125	J-19-267	161
J-16-329	101	J-16-1121	108	J-17-2042	125	J-19-268	162
J-16-700	100	J-16-1125	108	J-17-2060	125	J-19-270	162
J-16-705	100	J-16-1130	102	J-17-2062	125	J-19-271	162
J-16-710	100	J-16-1132	102	J-17-2070	126	J-19-272	162
J-16-720	101	J-16-1134	108	J-17-2072	126	J-19-273	162
J-16-725	101	J-16-1138	108	J-17-2080	126	J-19-277	162
J-16-730	101	J-16-1140	108	J-17-2082	126	J-19-458	161
J-16-735	101	J-16-1150	108	J-17-2086	126	J-19-468	162

Item Code	Page	Item Code	Page	Item Code	Page	Item Code	Page
J-19-470	162	J-20-1952	314	J-22-189	88	J-22-2092	51
J-19-471	162	J-20-1953	314	J-22-190	90	J-22-2100SC	50
J-19-472	162	J-20-1954	314	J-22-191	90	J-22-2112	51
J-19-473	162	J-20-1955	314	J-22-192	68	J-22-2113	51
J-19-1020	147	J-20-1956	314	J-22-193	68	J-22-2121	50
J-19-1070	134	J-20-1958	312	J-22-193B	68	J-22-2124	51
J-19-1080	134	J-20-1959	312	J-22-194	68	J-22-2126	51
J-19-1090	135	J-20-1962	313	J-22-195	68	J-22-2140	52
J-19-1100	135	J-20-1963	313	J-22-196	68	J-22-2141	52
J-19-1110	135	J-20-1964	313	J-22-197	58	J-22-2151	52
J-19-1112	135	J-20-1965	313	J-22-197A	58	J-22-2152	52
J-19-1114	135	J-20-1966	313	J-22-198	58	J-22-2153	52
J-19-1120	135	J-20-1967	313	J-22-201	57	J-22-2166	52
J-19-1122	135	J-20-1968	313	J-22-202	57	J-22-2167	52
J-19-1140	146	J-20-2760	136	J-22-207	50	J-22-2181	52
J-19-1182	138	J-20-2765	136	J-22-208	50	J-22-2182	52
J-19-1184	138	J-20-2770	136	J-22-208SC	50	J-22-2183	52
J-19-1186	138	J-20-2775	136	J-22-209	50	J-22-2184	52
J-19-1187	138	J-20-2780	136	J-22-210	50	J-22-2190	324
J-19-1188	138	J-22-0021	84	J-22-211	50	J-22-2201	324
J-19-1192	138	J-22-056	60	J-22-212	50	J-22-2210	324
J-19-1194	138	J-22-057	60	J-22-212SC	50	J-22-2300	53
J-19-1196	138	J-22-060	61	J-22-215	53	J-22-2301	53
J-19-1200	141	J-22-063	61	J-22-216	53	J-22-2310	53
J-19-1210	141	J-22-066	61	J-22-216B	53	J-22-2311	53
J-19-1220	141	J-22-067	61	J-22-217	52	J-22-2312	53
J-19-1222	141	J-22-072	61	J-22-218	52	J-22-2313	53
J-19-1224	141	J-22-073	61	J-22-223	82	J-22-2329	53
J-19-1226	141	J-22-100	71	J-22-223A	82	J-22-2331	53
J-19-1228	141	J-22-102	71	J-22-224	82	J-22-2342	53
J-19-1230	141	J-22-102SC	71	J-22-225	82	J-22-2343	53
J-19-1240	141	J-22-104	71	J-22-232	81	J-22-2344	53
J-19-1245	142	J-22-104A	71	J-22-233	81	J-22-2345	55
J-19-1250	312	J-22-106	71	J-22-233B	81	J-22-2346	55
J-19-1252	312	J-22-106B	71	J-22-350	56	J-22-2351	55
J-19-1254	312	J-22-111	71	J-22-351	56	J-22-2352	55
J-19-1260	313	J-22-113	71	J-22-355	56	J-22-2360	54
J-19-1270	313	J-22-116	71	J-22-356	56	J-22-2362	54
J-19-1280	151	J-22-118	71	J-22-360	56	J-22-2370	56
J-19-1282	151	J-22-130	67	J-22-375	56	J-22-2380	57
J-19-1291	152	J-22-132	67	J-22-376	56	J-22-2381	54
J-19-1292	152	J-22-132SC	67	J-22-377	56	J-22-2382	54
J-19-1294	152	J-22-151	69	J-22-378	56	J-22-2390	54
J-19-1296	152	J-22-153	69	J-22-575	68	J-22-2392	54
J-19-1298	152	J-22-155	63	J-22-590	53	J-22-2411	55
J-19-1310	160	J-22-156	63	J-22-591	53	J-22-2412	55
J-19-1312	160	J-22-157	63	J-22-595	52	J-22-2413	57
J-19-1320	160	J-22-158	63	J-22-595B	52	J-22-2414	57
J-19-1322	160	J-22-159	63	J-22-596	52	J-22-2420	57
J-19-1330	160	J-22-160	63	J-22-730	58	J-22-2421	57
J-19-1340	161	J-22-161	63	J-22-733	59	J-22-2422	57
J-19-1350	162	J-22-162	63	J-22-734	59	J-22-2423	57
J-19-1351	162	J-22-163	62	J-22-750	57	J-22-2426	55
J-19-1352	162	J-22-164	62	J-22-1890SC	88	J-22-2428	55
J-19-2340	145	J-22-165	62	J-22-1902	87	J-22-2440	58
J-19-2350	145	J-22-167	62	J-22-1903	87	J-22-2442	58
J-19-2360	145	J-22-168	62	J-22-2015	50	J-22-2451	58
J-19-3110	138	J-22-169	62	J-22-2020	50	J-22-2474	58
J-19-3300	160	J-22-171	70	J-22-2024	50	J-22-2480	58
J-19-4100	145	J-22-172	70	J-22-2026	50	J-22-2482	58
J-19-4110	145	J-22-173	54	J-22-2060	50	J-22-2500	59
J-19-4120	145	J-22-174	54	J-22-2066	50	J-22-2510	59
J-19-4130	145	J-22-180	86	J-22-2081	51	J-22-2530	59
J-20-1674	311	J-22-182	67	J-22-2082	51	J-22-2532	59
J-20-1951	314	J-22-186	79	J-22-2090	51	J-22-2540	59

Item Code	Page	Item Code	Page	Item Code	Page	Item Code	Page
J-22-2542	59	J-22-3040	70	J-22-3462	80	J-22-4460	93
J-22-2560	60	J-22-3060	70	J-22-3466	80	J-22-4462	93
J-22-2562	60	J-22-3080	71	J-22-3472	80	J-22-4470	93
J-22-2570	60	J-22-3120	71	J-22-3476	80	J-22-4472	93
J-22-2572	60	J-22-3122	71	J-22-3490	81	J-22-4490	94
J-22-2590	60	J-22-3130	71	J-22-3510	81	J-22-4492	94
J-22-2592	60	J-22-3132	71	J-22-3512	81	J-22-4500	94
J-22-2610	61	J-22-3160	72	J-22-3514	81	J-22-4502	94
J-22-2612	61	J-22-3162	72	J-22-3520	81	J-22-4510	94
J-22-2614	61	J-22-3164	72	J-22-3522	81	J-22-4512	94
J-22-2631	61	J-22-3170	72	J-22-3524	81	J-22-4520	94
J-22-2641	61	J-22-3172	72	J-22-3540	82	J-22-4522	94
J-22-2642	61	J-22-3174	72	J-22-3542	82	J-22-4530	94
J-22-2644	61	J-22-3190	72	J-22-3550	82	J-22-4532	94
J-22-2646	61	J-22-3192	72	J-22-3560	82	J-22-4540	95
J-22-2660	62	J-22-3194	72	J-22-3570	82	J-22-4542	95
J-22-2662	62	J-22-3200	72	J-22-3571	82	J-22-4544	95
J-22-2664	62	J-22-3202	72	J-22-3580	83	J-22-4546	95
J-22-2680	62	J-22-3204	72	J-22-3582	83	J-22-4550	95
J-22-2682	62	J-22-3220	73	J-22-3590	83	J-22-4560	95
J-22-2684	62	J-22-3224	73	J-22-3592	83	J-22-4562	95
J-22-2740	63	J-22-3230	73	J-22-3610	83	J-22-4564	95
J-22-2742	63	J-22-3234	73	J-22-3620	83	J-22-4566	95
J-22-2744	63	J-22-3240	73	J-22-3640	84	J-22-4570	95
J-22-2746	63	J-22-3241	74	J-22-3650	84	J-22-4572	95
J-22-2760	63	J-22-3242	74	J-22-3670	85	J-22-4574	95
J-22-2766	63	J-22-3244	73	J-22-3675	84	J-22-4576	95
J-22-2767	63	J-22-3250	73	J-22-3680	85	J-22-4580	96
J-22-2768	63	J-22-3251	74	J-22-4000	85	J-22-4582	96
J-22-2780	64	J-22-3252	74	J-22-4010	85	J-22-4584	96
J-22-2782	64	J-22-3254	73	J-22-4030	86	J-22-4586	96
J-22-2790	64	J-22-3270	75	J-22-4050	86	J-22-4590	96
J-22-2792	64	J-22-3272	75	J-22-4060	86	J-22-4592	96
J-22-2810	65	J-22-3274	75	J-22-4090	87	J-22-4594	96
J-22-2812	65	J-22-3280	73	J-22-4091	87	J-22-4596	96
J-22-2814	65	J-22-3281	73	J-22-4110	87	J-22-4601	96
J-22-2820	65	J-22-3282	75	J-22-4120	87	J-22-4602	96
J-22-2822	65	J-22-3284	75	J-22-4140	88	J-22-4604	96
J-22-2824	65	J-22-3286	75	J-22-4142	88	J-22-4611	96
J-22-2840	66	J-22-3290	73	J-22-4150	88	J-22-4612	96
J-22-2842	66	J-22-3300	76	J-22-4154	88	J-22-4614	96
J-22-2844	66	J-22-3310	74	J-22-4170	88	J-22-4624	98
J-22-2850	66	J-22-3312	74	J-22-4174	88	J-22-4630	98
J-22-2852	66	J-22-3320	76	J-22-4180	88	J-22-4640	98
J-22-2854	66	J-22-3321	74	J-22-4184	88	J-24-0040	110
J-22-2870	67	J-22-3322	74	J-22-4200	89	J-24-001	110
J-22-2880	67	J-22-3330	77	J-22-4205	89	J-24-002	110
J-22-2900	67	J-22-3332	77	J-22-4210	89	J-24-003	112
J-22-2920	68	J-22-3334	77	J-22-4215	89	J-24-004	110
J-22-2922	68	J-22-3340	77	J-22-4235	89	J-24-005	111
J-22-2930	68	J-22-3342	77	J-22-4245	89	J-24-006	112
J-22-2932	68	J-22-3344	77	J-22-4280	90	J-24-007	113
J-22-2934	68	J-22-3360	78	J-22-4300	91	J-24-008	110
J-22-2936	68	J-22-3362	78	J-22-4310	91	J-24-009	112
J-22-2950	68	J-22-3370	79	J-22-4320	91	J-24-010	110
J-22-2952	68	J-22-3380	79	J-22-4330	91	J-24-011	111
J-22-2962	68	J-22-3384	79	J-22-4340	91	J-24-012	111
J-22-2964	68	J-22-3400	79	J-22-4360	92	J-24-013	111
J-22-2966	68	J-22-3404	79	J-22-4370	92	J-24-014	111
J-22-2980	69	J-22-3411	79	J-22-4390	92	J-24-015	111
J-22-2981	69	J-22-3414	79	J-22-4400	92	J-24-016	111
J-22-3000	69	J-22-3432	80	J-22-4420	93	J-24-017	111
J-22-3001	69	J-22-3436	80	J-22-4422	93	J-24-018	111
J-22-3020	69	J-22-3440	80	J-22-4430	93	J-24-019	111
J-22-3022	69	J-22-3444	80	J-22-4432	93	J-24-020	111

Item Code	Page	Item Code	Page	Item Code	Page	Item Code	Page
J-24-021	111	J-24-2063	115	J-24-2223	116	J-24-2658	115
J-24-022	111	J-24-2067	115	J-24-2230	116	J-24-2669	115
J-24-023	112	J-24-2070	115	J-24-2231	116	J-24-2675	111
J-24-024	112	J-24-2072	115	J-24-2232	116	J-24-2680	112
J-24-037	113	J-24-2076	115	J-24-2233	116	J-24-2681	112
J-24-038	113	J-24-2078	115	J-24-2240	116	J-25-0016	315
J-24-039	113	J-24-2081	115	J-24-2241	116	J-25-0017	315
J-24-040	113	J-24-2083	115	J-24-2242	116	J-25-0018	315
J-24-041	113	J-24-2086	115	J-24-2243	116	J-25-0019	315
J-24-044	113	J-24-2089	115	J-24-2250	117	J-25-0026	315
J-24-045	113	J-24-2090	116	J-24-2254	117	J-25-910	134
J-24-046	113	J-24-2091	116	J-24-2260	117	J-25-912	134
J-24-047	113	J-24-2092	116	J-24-2264	117	J-25-913	134
J-24-048	112	J-24-2093	116	J-24-2270	117	J-25-915	134
J-24-204	110	J-24-2100	116	J-24-2274	117	J-26-110	136
J-24-210	113	J-24-2101	116	J-24-2280	117	J-26-110A	136
J-24-211	113	J-24-2102	116	J-24-2284	117	J-26-140	146
J-24-240	114	J-24-2103	116	J-24-2290	117	J-27-600	107
J-24-241	114	J-24-2110	116	J-24-2294	117	J-27-605	107
J-24-242	114	J-24-2111	116	J-24-2302	117	J-27-610	107
J-24-243	114	J-24-2112	116	J-24-2304	117	J-27-5950	107
J-24-244	114	J-24-2113	116	J-24-2312	117	J-30-150	134
J-24-255	114	J-24-2120	116	J-24-2314	117	J-30-160	134
J-24-256	114	J-24-2121	116	J-24-2320	117	J-30-320	140, 230
J-24-257	114	J-24-2122	116	J-24-2324	117	J-31-002	164
J-24-258	114	J-24-2123	116	J-24-2330	117	J-31-003	164
J-24-259	114	J-24-2130	116	J-24-2334	117	J-31-004	164
J-24-270	114	J-24-2131	116	J-24-2340	117	J-31-005	164
J-24-271	114	J-24-2132	116	J-24-2344	117	J-31-006	164
J-24-272	114	J-24-2133	116	J-24-2350	117	J-31-007	164
J-24-273	114	J-24-2140	116	J-24-2354	117	J-31-008	164
J-24-274	114	J-24-2141	116	J-24-2360	117	J-31-009	164
J-24-285	114	J-24-2142	116	J-24-2364	117	J-31-011	164
J-24-286	114	J-24-2143	116	J-24-2370	117	J-31-012	164
J-24-287	114	J-24-2150	116	J-24-2374	117	J-31-013	164
J-24-288	114	J-24-2151	116	J-24-2380	117	J-31-015	167
J-24-289	114	J-24-2152	116	J-24-2384	117	J-31-016	167
J-24-1145	111	J-24-2153	116	J-24-2390	117	J-31-017	167
J-24-1200	113	J-24-2160	116	J-24-2394	117	J-31-018	167
J-24-1201	113	J-24-2161	116	J-24-2401	117	J-31-021	165
J-24-1202	113	J-24-2162	116	J-24-2404	117	J-31-022	165
J-24-1203	113	J-24-2163	116	J-24-2410	118	J-31-023	165
J-24-1530	110	J-24-2170	116	J-24-2414	118	J-31-024	165
J-24-1560	113	J-24-2171	116	J-24-2418	118	J-31-025	165
J-24-2000	110	J-24-2172	116	J-24-2420	118	J-31-026	166
J-24-2010	111	J-24-2173	116	J-24-2424	118	J-31-027	166
J-24-2012	111	J-24-2180	116	J-24-2428	118	J-31-028	166
J-24-2014	111	J-24-2181	116	J-24-2430	118	J-31-031	166
J-24-2016	111	J-24-2182	116	J-24-2434	118	J-31-032	166
J-24-2020	113	J-24-2183	116	J-24-2438	118	J-31-033	166
J-24-2030	114	J-24-2190	116	J-24-2440	118	J-31-034	166
J-24-2031	114	J-24-2191	116	J-24-2444	118	J-31-035	166
J-24-2032	114	J-24-2192	116	J-24-2448	118	J-31-036	166
J-24-2033	114	J-24-2193	116	J-24-2450	118	J-31-040	167
J-24-2034	114	J-24-2200	116	J-24-2454	118	J-31-041	167
J-24-2040	114	J-24-2201	116	J-24-2458	118	J-31-042	167
J-24-2041	114	J-24-2202	116	J-24-2460	118	J-31-043	167
J-24-2042	114	J-24-2203	116	J-24-2464	118	J-31-044	167
J-24-2043	114	J-24-2210	116	J-24-2468	118	J-31-045	167
J-24-2044	114	J-24-2211	116	J-24-2470	118	J-31-060	167
J-24-2045	114	J-24-2212	116	J-24-2474	118	J-31-065	167
J-24-2050	115	J-24-2213	116	J-24-2478	118	J-31-070	167
J-24-2052	115	J-24-2220	116	J-24-2480	118	J-31-080	167
J-24-2056	115	J-24-2221	116	J-24-2484	118	J-31-081	167
J-24-2061	115	J-24-2222	116	J-24-2488	118	J-31-090	167

Item Code	Page	Item Code	Page	Item Code	Page	Item Code	Page
J-31-095	167	J-31-480	170	J-31-980	181	J-31-2120	168
J-31-100	167	J-31-490	170	J-31-981	181	J-31-2125	168
J-31-110	167	J-31-500	170	J-31-990	196	J-31-2130	168
J-31-111	167	J-31-510	170	J-31-1000	196	J-31-2135	168
J-31-120	167	J-31-520	170	J-31-1010	196	J-31-2140	168
J-31-125	167	J-31-530	177	J-31-1020	197	J-31-2145	168
J-31-130	167	J-31-540	177	J-31-1030	197	J-31-2150	168
J-31-140	167	J-31-550	177	J-31-1040	197	J-31-2160	168
J-31-141	167	J-31-560	177	J-31-1050	197	J-31-2165	168
J-31-142	168	J-31-570	177	J-31-1060	197	J-31-2170	168
J-31-143	168	J-31-580	177	J-31-1070	107, 197	J-31-2175	168
J-31-144	168	J-31-590	177	J-31-1072	107	J-31-2180	168
J-31-145	168	J-31-600	177	J-31-1080	197	J-31-2200	171
J-31-146	168	J-31-610	177	J-31-1090	197	J-31-2205	171
J-31-147	168	J-31-620	177	J-31-1095	103	J-31-2210	171
J-31-148	168	J-31-630	177	J-31-1100	103, 197	J-31-2215	171
J-31-149	168	J-31-640	177	J-31-1110	103, 197	J-31-2220	171
J-31-150	167	J-31-650	177	J-31-1120	182	J-31-2225	171
J-31-155	167	J-31-660	177	J-31-1130	182	J-31-2230	171
J-31-160	167	J-31-670	181	J-31-1140	182	J-31-2235	171
J-31-170	167	J-31-680	181	J-31-1150	182	J-31-2240	171
J-31-175	167	J-31-690	181	J-31-1160	182	J-31-2250	171
J-31-180	167	J-31-700	181	J-31-1170	182	J-31-2260	171
J-31-190	167	J-31-710	181	J-31-1180	183	J-31-2270	171
J-31-200	167	J-31-720	181	J-31-1182	183	J-31-2300	172
J-31-205	167	J-31-730	181	J-31-1190	183	J-31-2301	172
J-31-207	167	J-31-740	181	J-31-1200	183	J-31-2305	172
J-31-208	167	J-31-750	181	J-31-1210	183	J-31-2310	172
J-31-209	167	J-31-760	181	J-31-1220	183	J-31-2315	172
J-31-210	167	J-31-770	181	J-31-1230	183	J-31-2320	172
J-31-212	167	J-31-780	181	J-31-1232	183	J-31-2325	172
J-31-214	167	J-31-790	181	J-31-1240	183	J-31-2350	173
J-31-216	167	J-31-800	181	J-31-1250	183	J-31-2355	173
J-31-218	167	J-31-810	181	J-31-1260	183	J-31-2360	173
J-31-220	167	J-31-820	181	J-31-1270	183	J-31-2365	173
J-31-222	167	J-31-830	181	J-31-1280	183	J-31-2370	173
J-31-224	167	J-31-831	181	J-31-1290	183	J-31-2372	173
J-31-226	167	J-31-840	181	J-31-1291	183	J-31-2374	173
J-31-228	167	J-31-841	181	J-31-1292	183	J-31-2390	173
J-31-240	169	J-31-850	181	J-31-1300	183	J-31-2392	173
J-31-241	169	J-31-851	181	J-31-1301	183	J-31-2394	173
J-31-245	168	J-31-860	181	J-31-1302	183	J-31-2396	173
J-31-250	169	J-31-861	181	J-31-1310	183	J-31-2398	173
J-31-260	169	J-31-870	181	J-31-1311	183	J-31-2400	173
J-31-270	169	J-31-871	181	J-31-1312	183	J-31-2402	173
J-31-280	169	J-31-880	181	J-31-1320	183	J-31-2410	173
J-31-290	169	J-31-881	181	J-31-1330	183	J-31-2412	173
J-31-300	169	J-31-890	181	J-31-1340	183	J-31-2414	173
J-31-310	169	J-31-891	181	J-31-1350	183	J-31-2416	173
J-31-320	169	J-31-900	181	J-31-1360	183	J-31-2418	173
J-31-330	170	J-31-901	181	J-31-1385	188	J-31-2420	173
J-31-340	170	J-31-910	181	J-31-1386	188	J-31-2422	173
J-31-350	170	J-31-911	181	J-31-1387	188	J-31-2430	173
J-31-360	170	J-31-920	181	J-31-1388	188	J-31-2432	173
J-31-370	170	J-31-921	181	J-31-1389	188	J-31-2440	173
J-31-380	170	J-31-930	181	J-31-2000	168	J-31-2442	173
J-31-390	170	J-31-931	181	J-31-2010	168	J-31-2444	173
J-31-400	170	J-31-940	181	J-31-2015	168	J-31-2450	173
J-31-410	170	J-31-941	181	J-31-2020	168	J-31-2452	173
J-31-420	170	J-31-950	181	J-31-2025	168	J-31-2454	173
J-31-430	170	J-31-951	181	J-31-2030	168	J-31-2460	173
J-31-440	170	J-31-960	181	J-31-2035	168	J-31-2465	173
J-31-450	170	J-31-961	181	J-31-2100	168	J-31-2470	173
J-31-460	170	J-31-970	181	J-31-2110	168	J-31-2475	173
J-31-470	170	J-31-971	181	J-31-2115	168	J-31-2480	173

Item Code	Page	Item Code	Page	Item Code	Page	Item Code	Page
J-31-2485	173	J-31-2935	180	J-31-3261	186	J-32-0007	219
J-31-2500	174	J-31-2940	180	J-31-3265	186	J-32-0008	219
J-31-2505	174	J-31-3000	184	J-31-3266	186	J-32-0009	219
J-31-2510	174	J-31-3001	184	J-31-3270	186	J-32-0011	136
J-31-2515	174	J-31-3050	184	J-31-3271	186	J-32-0012	136
J-31-2520	174	J-31-3051	184	J-31-3275	186	J-32-0014	228
J-31-2525	174	J-31-3055	184	J-31-3276	186	J-32-0018	228
J-31-2530	174	J-31-3056	184	J-31-3280	186	J-32-0019	136
J-31-2535	174	J-31-3060	184	J-31-3281	186	J-32-0055	219
J-31-2540	174	J-31-3061	184	J-31-3285	186	J-32-001	191
J-31-2545	174	J-31-3065	184	J-31-3286	186	J-32-010	191
J-31-2550	174	J-31-3066	184	J-31-3300	186	J-32-020	191
J-31-2555	174	J-31-3080	184	J-31-3301	186	J-32-030	191
J-31-2560	174	J-31-3081	184	J-31-3305	186	J-32-040	191
J-31-2570	174	J-31-3090	184	J-31-3306	186	J-32-050	191
J-31-2575	174	J-31-3091	184	J-31-3310	186	J-32-051	191
J-31-2580	174	J-31-3100	185	J-31-3311	186	J-32-052	191
J-31-2585	174	J-31-3101	185	J-31-3315	186	J-32-053	192
J-31-2590	175	J-31-3105	185	J-31-3316	186	J-32-100	192
J-31-2595	175	J-31-3106	185	J-31-3320	186	J-32-110	192
J-31-2600	175	J-31-3110	185	J-31-3321	186	J-32-120	192
J-31-2605	175	J-31-3111	185	J-31-3325	186	J-32-125	192
J-31-2610	175	J-31-3115	185	J-31-3326	186	J-32-130	192
J-31-2615	175	J-31-3116	185	J-31-3330	186	J-32-131	193
J-31-2620	175	J-31-3120	185	J-31-3331	186	J-32-132	193
J-31-2630	175	J-31-3121	185	J-31-3335	186	J-32-133	193
J-31-2640	175	J-31-3125	185	J-31-3336	186	J-32-134	193
J-31-2650	175	J-31-3126	185	J-31-3370	187	J-32-135	194
J-31-2660	176	J-31-3130	185	J-31-3371	187	J-32-136	194
J-31-2670	176	J-31-3131	185	J-31-3375	187	J-32-137	194
J-31-2680	176	J-31-3135	185	J-31-3376	187	J-32-138	194
J-31-2690	176	J-31-3136	185	J-31-3400	187	J-32-139	194
J-31-2700	176	J-31-3150	185	J-31-3401	187	J-32-140	191
J-31-2710	176	J-31-3151	185	J-31-3405	187	J-32-141	191
J-31-2715	176	J-31-3155	185	J-31-3406	187	J-32-142	192
J-31-2720	176	J-31-3156	185	J-31-3410	187	J-32-143	192
J-31-2725	176	J-31-3160	185	J-31-3411	187	J-32-144	195
J-31-2730	176	J-31-3161	185	J-31-3415	187	J-32-145	195
J-31-2735	176	J-31-3165	185	J-31-3416	187	J-32-146	195
J-31-2740	176	J-31-3166	185	J-31-3420	187	J-32-147	195
J-31-2760	178	J-31-3180	185	J-31-3421	187	J-32-160	190
J-31-2770	178	J-31-3181	185	J-31-3425	187	J-32-170	190
J-31-2780	178	J-31-3185	185	J-31-3426	187	J-32-180	190
J-31-2790	178	J-31-3186	185	J-31-3430	187	J-32-190	190
J-31-2800	179	J-31-3200	186	J-31-3431	187	J-32-200	190
J-31-2805	179	J-31-3201	186	J-31-3435	187	J-32-210	190
J-31-2810	179	J-31-3205	186	J-31-3436	187	J-32-220	190
J-31-2815	179	J-31-3206	186	J-31-3450	187	J-32-230	190
J-31-2820	179	J-31-3210	186	J-31-3451	187	J-32-240	190
J-31-2825	179	J-31-3211	186	J-31-3455	187	J-32-250	190
J-31-2830	179	J-31-3215	186	J-31-3456	187	J-32-260	190
J-31-2835	179	J-31-3216	186	J-31-3460	187	J-32-270	190
J-31-2840	179	J-31-3220	186	J-31-3461	187	J-32-280	190
J-31-2860	179	J-31-3221	186	J-31-3465	187	J-32-290	196
J-31-2865	179	J-31-3225	186	J-31-3466	187	J-32-300	196
J-31-2870	179	J-31-3226	186	J-31-3470	187	J-32-310	196
J-31-2875	179	J-31-3230	186	J-31-3471	187	J-32-320	196
J-31-2880	179	J-31-3231	186	J-31-3475	187	J-32-330	196
J-31-2885	179	J-31-3235	186	J-31-3476	187	J-32-371	197
J-31-2890	179	J-31-3236	186	J-31-3480	187	J-32-372	197
J-31-2900	180	J-31-3250	186	J-31-3481	187	J-32-373	103, 197
J-31-2910	180	J-31-3251	186	J-31-3485	187	J-32-374	198
J-31-2920	180	J-31-3255	186	J-31-3486	187	J-32-375	198
J-31-2925	180	J-31-3256	186	J-31-3570	197	J-32-376	198
J-31-2930	180	J-31-3260	186	J-32-0006	219	J-32-377	198

Item Code	Page	Item Code	Page	Item Code	Page	Item Code	Page
J-32-378	198	J-32-1070	210	J-32-1487	142, 229	J-32-1710	232
J-32-379	198	J-32-1080	210	J-32-1488	137, 229	J-32-1720	232
J-32-382	199	J-32-1081	211	J-32-1489	137, 229	J-32-1730	232
J-32-383	199	J-32-1082	211	J-32-1491	137, 229	J-32-1780	233
J-32-385	199	J-32-1083	211	J-32-1492	137, 229	J-32-1790	233
J-32-386	199	J-32-1084	211	J-32-1493	137, 229	J-32-1800	233
J-32-387	199	J-32-1085	211	J-32-1494	140, 230	J-32-1810	233
J-32-388	200	J-32-1086	211	J-32-1495	140, 230	J-32-1820	233
J-32-389	200	J-32-1087	211	J-32-1496	143, 230	J-32-1830	233
J-32-391	200	J-32-1088	211	J-32-1497	143, 230	J-32-1840	233
J-32-392	200	J-32-1089	211	J-32-1498	143, 230	J-32-1850	233
J-32-393	200	J-32-1090	212	J-32-1520	238	J-32-1860	233
J-32-394	200	J-32-1091	211	J-32-1530	238	J-32-1870	233
J-32-395	200	J-32-1100	212	J-32-1535	237	J-32-1880	233
J-32-396	200	J-32-1110	212	J-32-1536	237	J-32-1882	232
J-32-397	203	J-32-1120	212	J-32-1537	237	J-32-1884	232
J-32-398	203	J-32-1130	212	J-32-1571	247	J-32-1890	234
J-32-399	203	J-32-1140	212	J-32-1572	247	J-32-1900	234
J-32-400	203	J-32-1150	212	J-32-1573	247	J-32-1910	234
J-32-403	204	J-32-1160	212	J-32-1574	259	J-32-1920	234
J-32-404	204	J-32-1170	212	J-32-1575	259	J-32-1950	232
J-32-405	204	J-32-1180	212	J-32-1576	259	J-32-1960	234
J-32-406	204	J-32-1190	212	J-32-1577	259	J-32-1970	234
J-32-407	204	J-32-1200	212	J-32-1578	259	J-32-1980	234
J-32-420	204	J-32-1210	212	J-32-1579	259	J-32-1990	234
J-32-422	204	J-32-1220	212	J-32-1581	259	J-32-2000	234
J-32-424	204	J-32-1223	213	J-32-1582	259	J-32-2001	234
J-32-426	204	J-32-1224	213	J-32-1583	259	J-32-2010	234
J-32-430	204	J-32-1230	212	J-32-1584	259	J-32-2020	234
J-32-432	204	J-32-1231	213	J-32-1585	259	J-32-2030	234
J-32-434	204	J-32-1232	213	J-32-1586	259	J-32-2040	234
J-32-436	204	J-32-1233	213	J-32-1587	260	J-32-2050	234
J-32-780	203	J-32-1240	214	J-32-1588	260	J-32-2060	234
J-32-781	203	J-32-1250	214	J-32-1589	260	J-32-2065	234
J-32-782	203	J-32-1260	214	J-32-1591	260	J-32-2100	215
J-32-810	205	J-32-1270	214	J-32-1592	260	J-32-2110	215
J-32-820	205	J-32-1280	214	J-32-1593	260	J-32-2120	215
J-32-830	205	J-32-1290	214	J-32-1594	260	J-32-2130	215
J-32-840	205	J-32-1300	214	J-32-1595	260	J-32-2140	220
J-32-850	205	J-32-1305	214	J-32-1596	139, 265	J-32-2150	220
J-32-860	205	J-32-1310	214	J-32-1597	139, 265	J-32-2160	220
J-32-870	205	J-32-1320	214	J-32-1598	148, 265	J-32-2170	220
J-32-879	205	J-32-1330	214	J-32-1599	148, 265	J-32-2180	220
J-32-880	205	J-32-1340	225	J-32-1601	139, 149, 265	J-32-2190	220
J-32-890	205	J-32-1350	225	J-32-1602	268	J-32-2200	220
J-32-900	205	J-32-1360	225	J-32-1602B	268	J-32-2210	220
J-32-910	205	J-32-1370	225	J-32-1603	268	J-32-2230	215
J-32-920	205	J-32-1380	225	J-32-1604	268	J-32-2240	215
J-32-925	205	J-32-1390	225	J-32-1604B	268	J-32-2260	221
J-32-925A	201	J-32-1400	225, 258	J-32-1605	268	J-32-2261	221
J-32-926	205	J-32-1410	225, 258	J-32-1606	266	J-32-2262	221
J-32-927	205	J-32-1420	225, 258	J-32-1607	266	J-32-2263	221
J-32-928	201	J-32-1430	225	J-32-1608	108, 266	J-32-2270	218
J-32-929	201	J-32-1440	225	J-32-1609	266	J-32-2271	218
J-32-930	208	J-32-1450	226	J-32-1611	266	J-32-2272	218
J-32-940	208	J-32-1455	226	J-32-1620	181, 232	J-32-2280	218
J-32-950	208	J-32-1460	226	J-32-1621	149	J-32-2290	218
J-32-951	208	J-32-1470	226	J-32-1630	181, 232	J-32-2291	218
J-32-953	97	J-32-1480	226	J-32-1640	181, 232	J-32-2300	218
J-32-954	207	J-32-1481	137, 229	J-32-1650	181, 232	J-32-2305	218
J-32-960	210	J-32-1482	136, 229	J-32-1660	181, 232	J-32-2310	218
J-32-970	210	J-32-1483	136, 229	J-32-1670	232	J-32-2320	217
J-32-980	210	J-32-1484	136, 229	J-32-1680	232	J-32-2321	217
J-32-990	210	J-32-1485	136, 229	J-32-1690	232	J-32-2322	217
J-32-1060	210	J-32-1486	142, 229	J-32-1700	232	J-32-2323	217

Item Code	Page	Item Code	Page	Item Code	Page	Item Code	Page
J-32-2330	217	J-32-2850	250	J-32-3151	261	J-32-3421	267
J-32-2331	217	J-32-2851	250	J-32-3152	261	J-32-3425	267
J-32-2332	217	J-32-2852	250	J-32-3153	261	J-32-3426	267
J-32-2340	217	J-32-2860	250	J-32-3160	261	J-32-3440	251
J-32-2350	222	J-32-2861	250	J-32-3161	261	J-32-3445	251
J-32-2351	222	J-32-2870	250	J-32-3162	261	J-32-3500	227
J-32-2360	222	J-32-2871	250	J-32-3170	254, 261	J-32-3505	227
J-32-2361	222	J-32-2872	250	J-32-3171	254, 261	J-32-3510	221
J-32-2362	222	J-32-2880	250	J-32-3172	254, 261	J-32-3511	221
J-32-2410	227	J-32-2881	250	J-32-3173	254, 261	J-32-3512	221
J-32-2420	227	J-32-2890	250	J-32-3174	254, 261	J-32-3513	221
J-32-2430	231	J-32-2891	250	J-32-3175	254	J-32-3520	253
J-32-2440	231	J-32-2900	251	J-32-3176	254	J-32-3525	253
J-32-2450	222	J-32-2910	251	J-32-3190	261	J-32-3530	253
J-32-2451	222	J-32-2920	251	J-32-3192	262	J-32-3550	193
J-32-2460	223	J-32-2921	251	J-32-3193	262	J-32-3551	193
J-32-2470	223	J-32-2922	251	J-32-3194	262	J-32-3552	193
J-32-2520	223	J-32-2923	251	J-32-3195	262	J-32-3553	193
J-32-2530	223	J-32-2924	251	J-32-3196	262	J-32-3554	193
J-32-2540	223	J-32-2930	251	J-32-3197	262	J-32-3555	193
J-32-2550	223	J-32-2940	251	J-32-3200	264	J-32-3560	194
J-32-2560	223	J-32-2950	251	J-32-3201	264	J-32-3561	194
J-32-2570	224	J-32-2960	251	J-32-3202	264	J-32-3562	194
J-32-2580	224	J-32-2970	255	J-32-3203	264	J-32-3563	194
J-32-2590	224	J-32-2980	253	J-32-3210	269	J-32-3564	194
J-32-2600	224	J-32-2981	253	J-32-3211	269	J-32-3575	103
J-32-2605	224	J-32-2982	253	J-32-3212	264	J-32-3580	197, 103
J-32-2620	224	J-32-2983	253	J-32-3213	264	J-32-3595	199
J-32-2630	225	J-32-2984	253	J-32-3214	264	J-32-3597	199
J-32-2640	225, 258	J-32-2990	253	J-32-3220	269	J-32-3599	199
J-32-2650	227	J-32-2991	253	J-32-3221	269	J-32-3603	204
J-32-2660	227	J-32-3000	253	J-32-3230	269	J-32-3604	204
J-32-2670	140, 230	J-32-3001	253	J-32-3231	269	J-32-3605	204
J-32-2671	140, 230	J-32-3002	253	J-32-3235	264	J-32-3606	204
J-32-2680	231	J-32-3010	255	J-32-3237	264	J-32-3607	204
J-32-2685	231	J-32-3020	255	J-32-3240	270	J-32-3620	204
J-32-2686	231, 343	J-32-3030	255	J-32-3241	270	J-32-3622	204
J-32-2700	235	J-32-3040	255	J-32-3250	270	J-32-3624	204
J-32-2710	235	J-32-3041	255	J-32-3251	270	J-32-3626	204
J-32-2711	235	J-32-3050	256	J-32-3260	270	J-32-3630	211
J-32-2712	235	J-32-3051	256	J-32-3300	209	J-32-3635	211
J-32-2713	235	J-32-3052	256	J-32-3305	209	J-32-3640	211
J-32-2714	235	J-32-3053	256	J-32-3310	209	J-32-3650	211
J-32-2720	235	J-32-3054	256	J-32-3315	209	J-32-3655	211
J-32-2721	235	J-32-3055	256	J-32-3320	209	J-32-3670	260
J-32-2730	235	J-32-3056	256	J-32-3325	209	J-32-3675	260
J-32-2731	235	J-32-3057	256	J-32-3350	214	J-32-3680	260
J-32-2740	236	J-32-3058	256	J-32-3351	214	J-32-3685	260
J-32-2741	236	J-32-3059	256	J-32-3360	215	J-32-3690	260
J-32-2742	236	J-32-3070	256	J-32-3365	217	J-32-3695	260
J-32-2743	236	J-32-3080	256	J-32-3370	217	J-32-3710	147
J-32-2744	236	J-32-3090	256	J-32-3375	217	J-32-3711	147
J-32-2800	258	J-32-3110	256	J-32-3390	217	J-32-3712	147
J-32-2810	249	J-32-3111	256	J-32-3391	217	J-32-3713	147
J-32-2811	249	J-32-3130	260	J-32-3392	217	J-32-3714	147
J-32-2820	249	J-32-3131	260	J-32-3393	217	J-32-3715	147
J-32-2821	249	J-32-3132	260	J-32-3400	139, 265	J-32-3716	147
J-32-2830	249	J-32-3133	260	J-32-3401	139, 265	J-32-3717	147
J-32-2840	249	J-32-3134	260	J-32-3402	139, 265	J-32-5004	128
J-32-2841	249	J-32-3135	260	J-32-3403	139, 265	J-32-5005	128
J-32-2842	249	J-32-3136	260	J-32-3410	139, 265	J-32-5010	128
J-32-2843	249	J-32-3137	260	J-32-3411	139, 265	J-32-5021	128
J-32-2844	249	J-32-3138	260	J-32-3412	139, 265	J-32-5031	128
J-32-2845	249	J-32-3139	260	J-32-3413	139, 265	J-32-5032	128
J-32-2846	249	J-32-3150	261	J-32-3420	267	J-32-5041	128

Item Code	Page	Item Code	Page	Item Code	Page	Item Code	Page
J-32-5042	128	J-32-5245	132	J-32-5582	205	J-32-5942	252
J-32-5043	128	J-32-5251	132	J-32-5584	205	J-32-5944	252
J-32-5051	129	J-32-5252	132	J-32-5590	206	J-32-5950	252
J-32-5052	129	J-32-5253	132	J-32-5640	268	J-32-5952	252
J-32-5061	129	J-32-5254	132	J-32-5642	268	J-32-5954	252
J-32-5062	129	J-32-5255	132	J-32-5644	268	J-32-5960	252
J-32-5071	129	J-32-5262	132	J-32-5646	268	J-32-5962	252
J-32-5072	129	J-32-5263	132	J-32-5648	268	J-32-5964	252
J-32-5073	129	J-32-5264	132	J-32-5650	268	J-32-5970	252
J-32-5081	129	J-32-5265	132	J-32-5665	206	J-32-5972	252
J-32-5082	129	J-32-5272	132	J-32-5680	213	J-32-5980	252
J-32-5083	129	J-32-5273	132	J-32-5685	213	J-32-5982	252
J-32-5084	129	J-32-5274	132	J-32-5690	213	J-32-5984	252
J-32-5094	129	J-32-5275	132	J-32-5695	213	J-32-5990	254
J-32-5095	129	J-32-5301	140	J-32-5700	214	J-32-5992	254
J-32-5096	129	J-32-5360	195	J-32-5701	214	J-32-5994	254
J-32-5097	129	J-32-5361	195	J-32-5710	227	J-32-5996	254
J-32-5098	129	J-32-5362	195	J-32-5720	213	J-32-6000	254
J-32-5101	130	J-32-5363	195	J-32-5725	228	J-32-6002	254
J-32-5111	130	J-32-5364	195	J-32-5730	228	J-32-6004	254
J-32-5122	130	J-32-5365	195	J-32-5740	228	J-32-6010	257
J-32-5123	130	J-32-5370	192	J-32-5745	228	J-32-6020	257
J-32-5124	130	J-32-5380	192	J-32-5755	223	J-32-6022	257
J-32-5125	130	J-32-5392	239	J-32-5775	219	J-32-6024	257
J-32-5126	130	J-32-5394	239	J-32-5780	219	J-32-6030	257
J-32-5127	130	J-32-5400	239	J-32-5790	222	J-32-6032	257
J-32-5128	130	J-32-5421	244	J-32-5792	222	J-32-6034	257
J-32-5133	130	J-32-5423	244	J-32-5795	228	J-32-6040	255
J-32-5143	130	J-32-5426	244	J-32-5800	221	J-32-6045	257
J-32-5152	131	J-32-5428	244	J-32-5810	216	J-32-6050	262
J-32-5153	131	J-32-5431	244	J-32-5815	216	J-32-6052	262
J-32-5154	131	J-32-5432	244	J-32-5820	216	J-32-6054	262
J-32-5155	131	J-32-5440	242	J-32-5825	224	J-32-6066	254
J-32-5156	131	J-32-5442	242	J-32-5830	215	J-32-6080	271
J-32-5157	131	J-32-5444	242	J-32-5835	215	J-32-6082	271
J-32-5158	131	J-32-5446	242	J-32-5840	219	J-32-6090	271
J-32-5164	131	J-32-5448	242	J-32-5842	258	J-32-6092	271
J-32-5166	131	J-32-5450	242	J-32-5844	258	J-32-6100	271
J-32-5167	131	J-32-5455	242	J-32-5850	247	J-32-6105	271
J-32-5168	131	J-32-5460	244	J-32-5851	247	J-32-6110	272
J-32-5170	131	J-32-5461	242	J-32-5854	247	J-32-6120	272
J-32-5172	131	J-32-5462	242	J-32-5855	247	J-32-6130	272
J-32-5182	131	J-32-5464	242	J-32-5858	247	J-32-6140	273
J-32-5183	131	J-32-5465	244	J-32-5859	247	J-32-6150	273
J-32-5184	131	J-32-5466	242	J-32-5860	247	J-32-6152	273
J-32-5185	131	J-32-5468	242	J-32-5862	247	J-32-6160	273
J-32-5186	131	J-32-5470	244	J-32-5864	247	J-32-6162	273
J-32-5187	131	J-32-5475	143	J-32-5870	247	J-32-7001	194
J-32-5188	131	J-32-5480	142	J-32-5872	247	J-32-7002	194
J-32-5203	131	J-32-5485	142	J-32-5874	247	J-32-7003	194
J-32-5204	131	J-32-5490	140	J-32-5880	247	J-32-7005	194
J-32-5205	131	J-32-5495	146	J-32-5882	247	J-32-7006	194
J-32-5206	131	J-32-5510	148	J-32-5884	247	J-32-7007	194
J-32-5207	131	J-32-5512	148	J-32-5890	248	J-32-7009	194
J-32-5208	131	J-32-5530	149	J-32-5892	248	J-32-7010	194
J-32-5210	131	J-32-5535	149	J-32-5894	248	J-32-7011	194
J-32-5212	131	J-32-5540	150	J-32-5900	248	J-32-7013	194
J-32-5222	131	J-32-5550	198	J-32-5902	248	J-32-7014	194
J-32-5224	131	J-32-5555	200	J-32-5904	248	J-32-7015	194
J-32-5232	132	J-32-5556	200	J-32-5910	248	J-32-7017	194
J-32-5235	132	J-32-5560	199	J-32-5912	248	J-32-7018	194
J-32-5241	132	J-32-5570	205	J-32-5914	248	J-32-7019	194
J-32-5242	132	J-32-5571	205	J-32-5920	248	J-32-7021	194
J-32-5243	132	J-32-5572	205	J-32-5930	248	J-32-7022	194
J-32-5244	132	J-32-5580	205	J-32-5940	252	J-32-7023	194

Item Code	Page	Item Code	Page	Item Code	Page	Item Code	Page
J-32-7025	194	J-32-7235	193	J-33-186	278, 281, 283	J-33-540	292
J-32-7026	194	J-32-7240	193	J-33-187	278, 281, 283	J-33-550	292
J-32-7027	194	J-32-7241	193	J-33-188	278, 281, 283	J-33-560	292
J-32-7029	194	J-32-7244	193	J-33-189	278	J-33-600	289
J-32-7030	194	J-32-7245	193	J-33-190	278	J-33-610	274, 289
J-32-7031	194	J-32-7250	193	J-33-191	278	J-33-620	289
J-32-7033	194	J-32-7251	193	J-33-195	279	J-33-630	290
J-32-7034	194	J-32-7254	193	J-33-196	279	J-33-640	290
J-32-7035	194	J-32-7255	193	J-33-197	279	J-33-641	290
J-32-7037	194	J-32-7300	194	J-33-198	279	J-33-642	290
J-32-7038	194	J-32-7301	194	J-33-199	279	J-33-643	290
J-32-7039	194	J-32-7304	194	J-33-200	285	J-33-650	150, 290
J-32-7140	193	J-32-7305	194	J-33-201	280, 285	J-33-670	290
J-32-7141	193	J-32-7320	194	J-33-202	280, 285	J-33-680	290
J-32-7143	193	J-32-7321	194	J-33-203	280, 285	J-33-681	290
J-32-7145	193	J-32-7324	194	J-33-205	285	J-33-682	290
J-32-7146	193	J-32-7325	194	J-33-220	286	J-33-683	290
J-32-7147	193	J-32-7330	194	J-33-230	286	J-33-684	290
J-32-7149	193	J-32-7331	194	J-33-240	286	J-33-700	159, 293
J-32-7150	193	J-32-7334	194	J-33-250	286	J-33-800	148, 265
J-32-7151	193	J-32-7335	194	J-33-260	286	J-33-801	148, 265
J-32-7153	193	J-32-7340	194	J-33-270	286	J-33-807	148
J-32-7154	193	J-32-7341	194	J-33-280	286	J-33-810	293
J-32-7155	193	J-32-7344	194	J-33-290	286	J-33-820	293
J-32-7157	193	J-32-7345	194	J-33-300	286	J-33-821	293
J-32-7158	193	J-32-7350	194	J-33-310	286	J-33-830	159, 293
J-32-7159	193	J-32-7351	194	J-33-320	286	J-33-831	159, 293
J-32-7161	193	J-32-7354	194	J-33-330	286	J-33-840	293
J-32-7162	193	J-32-7355	194	J-33-340	286	J-33-850	293
J-32-7163	193	J-32-7400	202	J-33-345	287	J-33-860	294
J-32-7164	193	J-32-7401	202	J-33-346	287	J-33-870	294
J-32-7165	193	J-32-7402	202	J-33-347	287	J-33-872	294
J-32-7166	193	J-32-8790	205	J-33-348	287	J-33-874	294
J-32-7167	193	J-32-9201	201	J-33-349	287	J-33-880	294
J-32-7168	193	J-32-9202	201	J-33-350	288	J-33-890	295
J-32-7169	193	J-32-9203	201	J-33-360	288	J-33-892	295
J-32-7170	193	J-33-0040	316	J-33-370	288	J-33-894	295
J-32-7171	193	J-33-0042	316	J-33-380	288	J-33-900	295
J-32-7173	193	J-33-001	276	J-33-390	288	J-33-902	295
J-32-7174	193	J-33-010	276	J-33-400	288	J-33-904	295
J-32-7175	193	J-33-020	276	J-33-410	288	J-33-910	295
J-32-7177	193	J-33-030	276	J-33-420	288	J-33-911	295
J-32-7178	193	J-33-040	276	J-33-430	288	J-33-912	295
J-32-7179	193	J-33-041	277	J-33-440	288	J-33-920	296
J-32-7181	193	J-33-042	277	J-33-442	288	J-33-921	296
J-32-7182	193	J-33-045	277	J-33-444	288	J-33-922	296
J-32-7183	193	J-33-050	276	J-33-446	288	J-33-923	296
J-32-7185	193	J-33-060	276	J-33-450	291	J-33-924	296
J-32-7186	193	J-33-070	276	J-33-460	291	J-33-925	296
J-32-7187	193	J-33-080	276	J-33-462	291	J-33-926	296
J-32-7200	193	J-33-090	276	J-33-464	291	J-33-930	157, 297
J-32-7201	193	J-33-100	276	J-33-470	291	J-33-940	297
J-32-7204	193	J-33-110	276	J-33-480	291	J-33-942	297
J-32-7205	193	J-33-120	276	J-33-490	291	J-33-944	297
J-32-7210	193	J-33-130	277	J-33-491	289	J-33-950	296
J-32-7211	193	J-33-140	277	J-33-492	289	J-33-951	296
J-32-7214	193	J-33-150	277	J-33-493	289	J-33-952	296
J-32-7215	193	J-33-159	278, 281, 282	J-33-494	289	J-33-953	296
J-32-7220	193	J-33-159S	280, 283, 284	J-33-495	274	J-33-954	296
J-32-7221	193	J-33-160	278	J-33-498	274	J-33-955	296
J-32-7224	193	J-33-170	278	J-33-500	292	J-33-956	296
J-32-7225	193	J-33-180	278	J-33-509	292	J-33-960	298
J-32-7230	193	J-33-181	278	J-33-510	292	J-33-970	298
J-32-7231	193	J-33-181S	280, 284	J-33-520	292	J-33-980	154, 299
J-32-7234	193	J-33-185	278	J-33-530	292	J-33-990	154, 299

Item Code	Page	Item Code	Page	Item Code	Page	Item Code	Page
J-33-1000	300	J-33-1850	283	J-33-7172	319	J-34-1140	337
J-33-1002	300	J-33-1851	281	J-33-7173	319	J-34-1150	337
J-33-1010	157, 300	J-33-1880	283	J-33-10810	322	JO-21-156	246
J-33-1020	153, 301	J-33-1881	283	J-33-10820	322	JO-21-157	245
J-33-1022	153, 301	J-33-1900	282, 284	J-33-10830	322	JO-21-163	245
J-33-1024	153, 301	J-33-1910	282, 284	J-33-10860	322	JO-21-164	245
J-33-1030	301	J-33-2001	312	J-33-10870	322	JO-21-168	246
J-33-1032	301	J-33-2002	312	J-33-10880	322	JO-21-170	246
J-33-1040	302	J-33-2004	158	J-33-10890	323	JO-21-171	246
J-33-1050	302	J-33-2005	274	J-33-10900	323	JO-21-172	246
J-33-1052	302	J-33-2007	158	J-33-10901	323	JO-21-189	238
J-33-1060	302	J-33-2010	274	J-34-001	330	JO-21-191	237
J-33-1070	302	J-33-2011	294	J-34-005	330	JO-21-192	237
J-33-1080	302	J-33-2015	312	J-34-020	330	JO-21-193	238
J-33-1081	322	J-33-2017	294	J-34-030	330	JO-21-194	238
J-33-1082	322	J-33-2018	294	J-34-040	330	JO-21-195	237
J-33-1083	322	J-33-2021	315	J-34-050	330	JO-21-196	237
J-33-1086	322	J-33-2022	315	J-34-060	331	JO-21-197	237
J-33-1087	322	J-33-2024	315	J-34-070	331	JO-21-198	240
J-33-1088	322	J-33-2025	295	J-34-080	331	JO-21-199	240
J-33-1089	323	J-33-2026	315	J-34-090	331	JO-21-200	240
J-33-1090	303	J-33-2031	315	J-34-100	331	JO-21-201	240
J-33-1092	303	J-33-2035	315	J-34-110	331	JO-21-202	241
J-33-1100	303	J-33-2040	315	J-34-120	331	JO-21-203	241
J-33-1102	303	J-33-2060	317	J-34-130	331	JO-21-204	241
J-33-1110	304	J-33-2070	318	J-34-140	332	JO-21-205	241
J-33-1120	305	J-33-2110	320	J-34-150	332	JO-21-206	241
J-33-1130	305	J-33-2130	320	J-34-151	332	JO-21-207	241
J-33-1140	305	J-33-2140	321	J-34-152	332	JO-21-277	219
J-33-1150	305	J-33-2150	321	J-34-153	332	JO-21-278	219
J-33-1160	305	J-33-2170	323	J-34-154	333	JO-21-279	219
J-33-1170	306	J-33-2180	323	J-34-156	333	JO-21-598	343
J-33-1180	307	J-33-2220	325	J-34-160	333	JO-21-670	227
J-33-1190	307	J-33-2230	325	J-34-161	333	JO-21-686	326
J-33-1200	308	J-33-2240	326	J-34-165	333	JO-21-687	326
J-33-1210	308	J-33-2250	326	J-34-180	335	JO-21-688	326
J-33-1220	308	J-33-2260	327	J-34-182	335	JO-21-689	326
J-33-1230	309	J-33-2262	327	J-34-190	334	JO-21-691	218
J-33-1240	309	J-33-2270	327	J-34-200	335	JO-21-1380	263
J-33-1250	307	J-33-2272	327	J-34-210	334	JO-21-1381	263
J-33-1260	307	J-33-2280	328	J-34-220	334	JO-21-1382	263
J-33-1270	310	J-33-2282	328	J-34-230	334	JO-21-1383	263
J-33-1280	310	J-33-2290	328	J-34-240	334	JO-21-1384	263
J-33-1290	311	J-33-2292	328	J-34-250	334	JO-21-1385	263
J-33-1292	311	J-33-2300	328	J-34-280	335	JO-21-1386	263
J-33-1294	311	J-33-2302	328	J-34-290	335	JO-21-1387	263
J-33-1296	311	J-33-2304	328	J-34-300	335	JO-21-1390	263
J-33-1300	311	J-33-2306	328	J-34-310	335	JO-21-1391	263
J-33-1302	311	J-33-2310	155	J-34-311	336	JO-21-1392	263
J-33-1380	289	J-33-2311	155	J-34-312	336	JO-21-1393	263
J-33-1381	289	J-33-2312	155	J-34-313	336	JO-21-1400	262
J-33-1390	139, 265	J-33-2313	155	J-34-314	336	JO-21-1401	262
J-33-1400	306	J-33-2314	155	J-34-315	336	JO-21-1402	262
J-33-1405	306	J-33-2315	155	J-34-316	338	JO-21-1410	262
J-33-1420	304	J-33-2316	155	J-34-317	338	JO-21-1411	262
J-33-1430	304	J-33-2320	156	J-34-318	338	JO-21-1412	262
J-33-1434	304	J-33-2321	156	J-34-319	338	JO-21-1413	262
J-33-1435	304	J-33-2322	156	J-34-320	338	JO-21-1520	246
J-33-1440	304	J-33-2323	156	J-34-321	338	JO-21-1521	246
J-33-1445	304	J-33-2324	156	J-34-322	338	JO-21-1525	246
J-33-1446	304	J-33-2325	156	J-34-1100	337	JO-21-1541	238
J-33-1600	282	J-33-2326	156	J-34-1110	337	JO-21-1991	218
J-33-1700	282	J-33-5002	321	J-34-1120	337	JO-21-1992	218
J-33-1800	282, 284	J-33-7169	319	J-34-1130	337	JO-21-1993	218
J-33-1810	282	J-33-7171	319	J-34-1132	337	JO-21-2075	227

Item Code	Page	Item Code	Page	Item Code	Page	Item Code	Page
JO-21-2230	246	JT-22-668	62	JT-22-1210	60	JT-22-1540	87
JO-21-2609A	257	JT-22-669	62	JT-22-1212	60	JT-22-1542	87
JO-21-3424	98	JT-22-671	62	JT-22-1220	64	JT-22-1550	87
JO-21-3424A	98	JT-22-672	62	JT-22-1222	64	JT-22-1560	88
JO-21-3590	263	JT-22-673	62	JT-22-1230	65	JT-22-1562	88
JO-21-3591	263	JT-22-674	62	JT-22-1232	65	JT-22-1564	88
JO-21-3592	263	JT-22-693	50	JT-22-1234	65	JT-22-1570	88
JO-21-3593	263	JT-22-694	50	JT-22-1240	66	JT-22-1574	88
JO-21-4800	245	JT-22-697	81	JT-22-1242	66	JT-22-1580	89
JO-21-4802	245	JT-22-698	81	JT-22-1244	66	JT-22-1585	89
JO-21-4804	245	JT-22-699	57	JT-22-1250	68	JT-22-1590	91
JO-21-4820	245	JT-22-700	67	JT-22-1252	68	JT-22-1592	89
JO-21-4830	257	JT-22-701	67	JT-22-1254	68	JT-22-1600	92
JO-21-4840	257	JT-22-702	79	JT-22-1256	68	JT-22-1610	92
JO-21-4842	257	JT-22-731	58	JT-22-1260	68	JT-22-1620	93
JO-21-5500	343	JT-22-732	58	JT-22-1262	68	JT-22-1622	93
JO-21-5550	237	JT-22-830	90	JT-22-1264	68	JT-22-1630	93
JO-21-5570	261	JT-22-835	90	JT-22-1266	68	JT-22-1632	93
JO-21-5572	261	JT-22-896	67	JT-22-1280	70	JT-22-1910SC	90
JO-21-5580	219	JT-22-1030	50	JT-22-1290	70	JT-22-2040	50
JO-21-5581	219	JT-22-1032	50	JT-22-1300	72	JT-22-2042	50
JO-21-5582	219	JT-22-1036	50	JT-22-1302	72	JT-22-2044	50
JO-21-7170	320	JT-22-1040	50	JT-22-1304	72	JT-22-2046	50
JO-21-7174	320	JT-22-1042	50	JT-22-1310	72	JT-22-2070	50
JO-21-9851	264	JT-22-1046	50	JT-22-1312	72	JT-22-2072	50
JT-16-621	100	JT-22-1050	51	JT-22-1314	72	JT-22-2074	50
JT-16-622	100	JT-22-1052	51	JT-22-1320	73	JT-22-2076	50
JT-16-623	100	JT-22-1060	51	JT-22-1322	73	JT-22-2102	51
JT-16-624	100	JT-22-1062	51	JT-22-1324	73	JT-22-2105	51
JT-16-800	100	JT-22-1070	52	JT-22-1326	73	JT-22-2130	51
JT-16-805	101	JT-22-1071	52	JT-22-1330	73	JT-22-2132	51
JT-16-810	101	JT-22-1072	52	JT-22-1340	74	JT-22-2160	52
JT-21-2500	343	JT-22-1073	52	JT-22-1342	74	JT-22-2161	52
JT-21-9851	264	JT-22-1080	52	JT-22-1350	74	JT-22-2162	52
JT-22-173	54	JT-22-1081	52	JT-22-1352	74	JT-22-2163	52
JT-22-174	54	JT-22-1082	52	JT-22-1360	75	JT-22-2290	52
JT-22-238	343	JT-22-1083	52	JT-22-1362	75	JT-22-2291	52
JT-22-618	71	JT-22-1090	53	JT-22-1364	75	JT-22-2292	52
JT-22-619	71	JT-22-1091	53	JT-22-1370	76	JT-22-2293	52
JT-22-621	71	JT-22-1092	53	JT-22-1380	77	JT-22-2320	53
JT-22-622	71	JT-22-1093	53	JT-22-1382	77	JT-22-2321	53
JT-22-624	71	JT-22-1100	53	JT-22-1384	77	JT-22-2322	53
JT-22-625	71	JT-22-1101	53	JT-22-1390	78	JT-22-2323	53
JT-22-626	71	JT-22-1102	53	JT-22-1392	78	JT-22-2350	53
JT-22-627	71	JT-22-1103	53	JT-22-1400	79	JT-22-2351	53
JT-22-628	69	JT-22-1120	54	JT-22-1410	79	JT-22-2352	53
JT-22-630	69	JT-22-1122	54	JT-22-1415	79	JT-22-2353	53
JT-22-632	69	JT-22-1130	55	JT-22-1420	80	JT-22-2360	55
JT-22-633	69	JT-22-1132	55	JT-22-1424	80	JT-22-2362	55
JT-22-638	61	JT-22-1140	57	JT-22-1430	80	JT-22-2370	54
JT-22-639	61	JT-22-1141	55	JT-22-1434	80	JT-22-2372	54
JT-22-640	61	JT-22-1142	55	JT-22-1440	81	JT-22-2400	57
JT-22-645	61	JT-22-1150	57	JT-22-1442	81	JT-22-2401	54
JT-22-646	61	JT-22-1152	57	JT-22-1444	81	JT-22-2402	54
JT-22-647	61	JT-22-1154	57	JT-22-1450	82	JT-22-2430	55
JT-22-652	63	JT-22-1156	57	JT-22-1451	82	JT-22-2431	55
JT-22-653	63	JT-22-1160	58	JT-22-1465	83	JT-22-2432	57
JT-22-654	63	JT-22-1170	58	JT-22-1467	83	JT-22-2433	57
JT-22-655	63	JT-22-1172	58	JT-22-1470	83	JT-22-2434	57
JT-22-659	63	JT-22-1180	59	JT-22-1480	84	JT-22-2436	57
JT-22-660	63	JT-22-1182	59	JT-22-1490	84	JT-22-2462	58
JT-22-661	63	JT-22-1190	59	JT-22-1500	85	JT-22-2490	58
JT-22-662	63	JT-22-1192	59	JT-22-1510	85	JT-22-2492	58
JT-22-666	62	JT-22-1200	60	JT-22-1520	86	JT-22-2520	59
JT-22-667	62	JT-22-1202	60	JT-22-1530	86	JT-22-2522	59

Item Code	Page	Item Code	Page	Item Code	Page	Item Code	Page
JT-22-2550	59	JT-22-3214	72	JT-24-605	121	JT-32-442	243
JT-22-2552	59	JT-22-3230	74	JT-24-606	119	JT-32-444	243
JT-22-2580	60	JT-22-3232	74	JT-24-607	119	JT-32-446	243
JT-22-2582	60	JT-22-3260	73	JT-24-608	119	JT-32-448	243
JT-22-2600	60	JT-22-3261	74	JT-24-609	119	JT-32-449	243
JT-22-2602	60	JT-22-3262	74	JT-24-610	119	JT-32-550	343
JT-22-2620	61	JT-22-3264	73	JT-24-611	119	JT-32-552	343
JT-22-2622	61	JT-22-3270	73	JT-24-612	120	JT-32-554	343
JT-22-2624	61	JT-22-3274	73	JT-24-613	120	JT-32-556	343
JT-22-2651	61	JT-22-3290	75	JT-24-614	120	JT-32-558	343
JT-22-2652	61	JT-22-3292	75	JT-24-615	120	JT-32-559	243
JT-22-2654	61	JT-22-3294	75	JT-24-616	120	JT-32-953	97, 207
JT-22-2656	61	JT-22-3300	73	JT-24-617	120	JT-32-954	207
JT-22-2670	62	JT-22-3320	76	JT-24-618	120	JT-32-5390	239
JT-22-2672	62	JT-22-3350	77	JT-24-619	120	JT-32-5410	239
JT-22-2674	62	JT-22-3352	77	JT-24-620	120	SD-2306-15	339
JT-22-2690	62	JT-22-3354	77	JT-24-621	120	SD-2306-20	339
JT-22-2692	62	JT-22-3390	79	JT-24-622	120	SD-2306-30	339
JT-22-2694	62	JT-22-3394	79	JT-24-623	120	SD-2306-50	339
JT-22-2750	63	JT-22-3420	79	JT-24-624	120		
JT-22-2752	63	JT-22-3424	79	JT-24-625	120		
JT-22-2754	63	JT-22-3450	80	JT-24-626	120		
JT-22-2756	63	JT-22-3451	81	JT-24-627	120		
JT-22-2770	63	JT-22-3452	81	JT-24-646	122		
JT-22-2772	63	JT-22-3454	80	JT-24-663	122		
JT-22-2774	63	JT-22-3482	80	JT-24-664	122		
JT-22-2776	63	JT-22-3486	80	JT-24-665	122		
JT-22-2800	64	JT-22-3530	81	JT-24-666	122		
JT-22-2802	64	JT-22-3532	81	JT-24-667	123		
JT-22-2830	65	JT-22-3534	81	JT-24-668	123		
JT-22-2832	65	JT-22-3560	83	JT-24-669	123		
JT-22-2834	65	JT-22-3562	83	JT-24-670	123		
JT-22-2860	66	JT-22-3630	83	JT-24-671	123		
JT-22-2862	66	JT-22-3660	84	JT-24-672	123		
JT-22-2864	66	JT-22-3690	84	JT-24-715	120		
JT-22-2890	67	JT-22-3900	85	JT-24-716	120		
JT-22-2910	67	JT-22-4020	85	JT-24-717	120		
JT-22-2912	67	JT-22-4040	86	JT-24-760	120		
JT-22-2940	68	JT-22-4070	86	JT-24-790	122		
JT-22-2942	68	JT-22-4100	87	JT-24-1220	119		
JT-22-2944	68	JT-22-4102	87	JT-24-1221	119		
JT-22-2946	68	JT-22-4130	87	JT-24-1350	121		
JT-22-2970	68	JT-22-4160	88	JT-24-1360	121		
JT-22-2972	68	JT-22-4162	88	JT-24-1370	121		
JT-22-2974	68	JT-22-4164	88	JT-24-1380	121		
JT-22-2976	68	JT-22-4190	88	JT-24-1382	121		
JT-22-3010	69	JT-22-4194	88	JT-24-1390	122		
JT-22-3011	69	JT-22-4220	89	JT-24-1392	122		
JT-22-3030	69	JT-22-4225	89	JT-24-1396	122		
JT-22-3032	69	JT-22-4255	89	JT-24-1398	122		
JT-22-3050	70	JT-22-4270	90	JT-24-1400	122		
JT-22-3070	70	JT-22-4290	90	JT-24-1402	122		
JT-22-3100	71	JT-22-4350	91	JT-24-1404	122		
JT-22-3104	71	JT-22-4380	92	JT-24-1410	122		
JT-22-3110	71	JT-22-4410	92	JT-24-1412	122		
JT-22-3114	71	JT-22-4450	93	JT-24-1420	123		
JT-22-3140	71	JT-22-4452	93	JT-31-3350	186		
JT-22-3142	71	JT-22-4480	93	JT-31-3351	186		
JT-22-3150	71	JT-22-4482	93	JT-31-3355	186		
JT-22-3152	71	JT-22-6449	61	JT-31-3356	186		
JT-22-3180	72	JT-24-600	119	JT-31-3360	186		
JT-22-3182	72	JT-24-601	119	JT-31-3361	186		
JT-22-3184	72	JT-24-602	119	JT-32-354	208		
JT-22-3210	72	JT-24-603	119	JT-32-370	97		
JT-22-3212	72	JT-24-604	119	JT-32-440	243		

ENT & Plastic Surgery
Instruments



Index Alphabetical

**Index
Alphabetical**

A

Abdominal Rake Retractor	141
Abdominal Rake Retractor, Coronal Brow Lift	141
Abdominal Rake Retractor, Freeman	141
Abdominal Rake Retractor, Freeman-Mini	141
Abdominal Rake Retractor, Gorney	141
Abdominal Rake Retractor, Yancoskie	141
Abdominal Retractor for Lipoabdominoplasty	317
Abdominal Retractor, Saldanha-Solz	317
Abraham, Tonsil Knives	331
Abscess Forceps, Ballenger	334
Abscess Forceps, Colver	334
Abscess Forceps, Museux	334
Abscess Forceps, White	334
Adaptor for Cannulas, Liposuction	30
Adaptors for Cannulas	30, 31
Adenoid Curetes, Beckmann	233
Adenoid Curetes, Coakley	232
Adenoid Curetes, Faulkner	232
Adenoid Curetes, Myles	232
Adenoid Curetes, St. Clair-Thomson	234
Adenoid Curetes, Tessier	232
Adson, Delicate Forceps	100,101
Adson, Delicate Retractors	134
Adson, Dressing & Tissue Forceps	100,101
Adson, Needle Holders	112
Adson, Suction tubes	10
Adson-Brown, Delicate Forceps	102
Adson-Graefe, Delicate Forceps	102
Agris Dingman Transauxillary Breast Dissectors	312
Agris Dingman, Breast Retractors	312,313
Aiach, Columella Suturing Forceps	266
Aiach, Septum Forceps	206
Air Bags, Politzer	172
Alar Hooklet, Lange	290
Alar Hooklets, Anderson	265
Alar Hooklets, Becker	265
Alar Hooklets, Cottle	230,265
Alar Hooklets, Cottle-Neiert	230
Alar Hooklets, Fomon	230
Alar Hooklets, Neivert	265
Alligator, Micro Cup-Shaped-Forceps	186
Alligator, Micro Ear Forceps	186
Alm, Self-retaining Retractors	161
Anderson, Alar Hooklets, Nasal Retractors	265
Anderson, Retractors	139
Anthelix Cartilage file for Auricular Plastics	327
Anthelix Cartilage file, Dingman	327
Antrum Cannula, Siebenmann	290
Antrum Curette, Halle	219
Antrum Punches Forceps, Ferris-Smith-Cushing	211
Arch Bar, Dingmann	231
Arch Bar, Gillies	231
Areola Marker	315
Areola Marker	315
Areola Marker, Solz	315
Arnhem, LeFort I Retractors	303
Arnhem, Sinus Lift Retractors	303
Asch, Rhinoplastic Instruments	268
Aufricht, Nasal Rasps/ Bone Files	237
Aufricht, Nasal Retractors	148,149,265
Aufricht, Retractors	139
Aufricht, Rhinoplasty Scissors	86
Aufricht-Walter, Nasal Retractors	149
Austin, Mico Dissectors/ Micro Ear Hooks	174

B

Baby-Metzenbaum, Delicate Dissecting Scissors	60
Ballenger	225
Ballenger, Abscess Forceps	334
Ballenger, Rhinoplastic & Nasal nives	212
Ballenger, Rhinoplastic Chisels & Oteotomes	258
Ballenger, Swivel Knives	225
Ballenger-Hajek, Septum Elevators	223
Ball-Socket	342
Barbara, Micro Ear Hooks/ Needles	173
Barker, Curetes & Scoop	177
Baron, Suction tubes	11
Barraquer, Micro Needle Holders	116,117
Barsky, Skin Hooks	135
Bauer, Osteotomes	249
Bayonet shape, Knives	328
Becker, Alar Hooklets / Nasal Retractors	265
Becker, Retractors	139
Beckman, Nasal Specula	192
Beckmann, Adenoid Curetes	233
Bellucci, Micro Ear Scissors	187
Benicke, Skin Hooks	135
Bergmann, Fistula hook	136
Bertillon, Marking & Measuring Instruments	340
Beyer, Mastoid Rongeurs	188
Billeau, Curetes & Scoop	177
Bishop, Lip & Cheek Retractors	289
Blade Holder, Scalpels	8
Blade Holding Forceps	346
Blocksmas, Hooks	271
Blohmke, Tonsil Seizing Forceps	335
Blume, Osteotomes	257
Boies, Periosteal Elevators	228
Bone Awl, Hand & Foot Surgery	132
Bone Bow Spacer	341
Bone Contouring Forceps, Marchac	209
Bone Contouring Forceps, Obwegeser	209
Bone Contouring Forceps, Tessier	209
Bone Curetes, Beckmann	233
Bone Curetes, Hand & Foot Surgery	132
Bone File, Hand & Foot Surgery	131
Bone Files, Aufricht	237
Bone Files, Gallaher	237
Bone Files, Lewis Rasp	237
Bone Holding Forceps, Hargis	337
Bone Holding Forceps, Keen	337
Bone Holding Forceps, Sakamoto	337
Bone Holding Forceps, Salyer	337
Bone Holding Forceps, Wolford	337
Bone Hook, Hand & Foot Surgery	128
Bone Instruments	264
Bone Level Elevator, Hand & Foot Surgery	130
Bosworth, Tongue Depressors	291
Boucheron, Ear Specula Storage Rack	168
Boyles, Mouth Gags	284
Bozemann, Needle Holders	122
Breast Dissectors	312
Breast Dissectors, Agris Dingman Transauxillary	312
Breast Dissectors, Solz	312
Breast Dissectors, Spatula	312
Breast Elevator	315
Breast Reduction Marker	315
Breast Retractors	313,316
Breast Retractors, Agris Dingman	312, 313
Breast Retractors, Converse	150

Breast Retractors, MacCollum	313
Breast Retractors, MacCollum Dingman	313
Breast Retractors, Marx	316
Breast Retractors, Reynolds	313
Bruce-Clarke, Needle Holders	112
Bruenings, Septum Forceps	200
Bruenings, Tongue Depressors & Spatula	288
Bruenings, Tonsil Snares	336
Buchwald, Tongue Depressors & Spatula	288
Buck, Ear Curetes	181
Buck, Extra Extra Fine Ear Curetes	181
Buck, Foreign Body Forceps	182
Buxton, Mouth Gags	277

C

Calipers, Castroviejo	341
Calipers, Castroviejo-Epker	342
Calipers, Jameson	339
Calipers, Thorpe	339
Calipers, Townley	340
Canfield, Tonsil Knives	331
Cannulas, Adaptor & Handles	30,31
Cannulas, Eicken-Killian	234
Cannulas, Hartmann	234
Cannulas, Killian	234
Cannulas, Liposuction	14-29, 32-44
Cannulas, Marchac	234
Caplan, Rhinoplasty Scissors	97
Caplan, Septum Scissors	207
Carpenter, Tonsil Knives	332
Cartila e & Bone Instruments	264
Cartila e Abraders, Dingman	327
Cartila e Crushers, Cottle	264
Cartila e Crushers, Gubisch	264
Cartila ge Cutting Block	264
Castroviejo, Calipers	341
Castroviejo, Micro Needle Holders	114,115
Castroviejo-Epker, Calipers	342
Cheek & Nasal Retractors, Converse	290
Chisel, Hand & Foot Surgery	131
Cinelli, Osteotomes	260
Cinelli, Rhinoplasty Scissors	85
Circular Cut Knives, Rosen	176
Citelli, Mastoid Rongeurs	188
Cleft alate Dissector, Salyer	220
Cleft alate Elevator, Salyer	220
Cleft alate Hooklets, Salyer	220
Cleft alate Instruments	220
Cleft alate Periosteal Elevator, Jaboma	220
Coakley, Adenoid Curetes	232
Cohen, Harvesting of Cottal Cartil es	213
Collier, Needle Holders	112
Collin, Hammer	245
Collin, Scalpel Handles	5
Collin, Tongue Depressors & Spatula	288
Collin, Tongue Holding Forceps	292
Columella Forceps, Cottle	266
Columella Suturing Forceps, Aiach	266
Colver, Abscess Forceps	334
Colver, Tonsil Knives	331
Combination Mall t, Hammer	246
Converse, Breast Retractors	150
Converse, Cheek & Nasal Retractors	290
Converse, Nasal Rasps	244
Converse, Nasal Retractors	229
Converse, Needle Holders	121

Converse, Periosteal Elevators	221
Converse, Retractors	142
Converse, Rhinoplastic & Nasal nives	213
Converse, Rhinoplasty Scissors	84
Cope-Walter, Delicate Retractors	146
Coronal Brow Lift etractor	141
Cottle (Millad), Retractors	140
Cottle Rasp, Nasal Rasps, Bone Files	237
Cottle, Alar Hookl ts, Nasal Retractors	265
Cottle, Cartil e Crushers	264
Cottle, Columella orceps	266
Cottle, Hammer	245
Cottle, Nasal Hoo s	229
Cottle, Nasal Rasps	239
Cottle, Nasal etractors	143,148
Cottle, Nasal Specula	192,194
Cottle, Oteotomes & Maxillary Mobilizer	255
Cottle, Oteotomes, Gougges, Cartil e Crusher	261
Cottle, eriosteal Elevators	228
Cottle, etractors	139,230
Cottle, Rhinoplastic & Nasalnives	212,213
Cottle, Rhinoplastic Chisels & teotomes	259
Cottle, Rhinoplaty Scissors	84,90,98
Cottle, Septum El vators/ Periosteal Elevators	223,224
Cottle, Septum orceps	266
Cottle, Tissue Gasping Forceps	108
Cottle, racheal hooks	136
Cottle- Fomon, Disimpactionorceps	268
Cottle-Gubisch, Rhinoplastic Chisels & teotomes	252
Cottle-Masin , Needle Holders	122
Cottle-Masin , Rhinoplasty Scissors	83
Cottle-Nei ert, Retractors	140,230
Cottle- Walsham, Disimpactionorceps	268
Craig-Domnick, Ethmoid Bone Forceps	199
Crano Maxilla-Facial Surgery	296-311
Craword Minnesota, Retractors	274
Crile, Delicate Retractors	134
Crile, Hemostatic orceps	126
Crile-Murray, Needle Holders	110
Crile-wood, Needle Holders	111,120
Crushing Plier, Mod.	264
Curette, Williger-Walter	219
Curetes & Scoop, Barker	177
Curetes & Scoop, Billeau	177
Curetes & Scoop, Gross	177
Cushing Retractor, Hand & Foot Surgery	129

D

Dautrey Munro, Osteotomes	249
Davis Boyle, Mouth Gags	278, 282
Day, Ear Hooklets	179
Day, Tonsil Knives	331
De Bakey, Needle Holders	120
Dean, Gum Scissors	79,80
Deaver, Nasal Retractors	144,145
DeBakey, Tissue Grasping Forceps	107
Delabarre, Mouth Gags	277
Delicate Dissecting Scissos	54-62
Delicate Dissecting Scissos, Baby-Metzenbaum	60
Delicate Dissecting Scissos, Greenberg PAR	57
Delicate Dissecting Scissos, Iris	56
Delicate Dissecting Scissos, Joseph	58
Delicate Dissecting Scissos, Knapp	54,55,56
Delicate Dissecting Scissos, Lexer-Baby	54
Delicate Dissecting Scissos, Metzenbaum-Fino	62
Delicate Dissecting Scisso s, Mini- Metzenbaum	60

Ear Specula, Politzer	167
Ear Specula, Pritchard	167
Ear Specula, Toynbee	167
Ear Specula, Troeltsch	167
Eicken-Killian, Cannulas	234
Eiselsberg, Needle Holders	112
Elevator, Nagata	326
Elevators	321-324
Elevators, Breast	315
Elevators, Dingman	215
Elevators, Obwegeser-Freer	215
Elevators, Terry	215
Emmet, Tracheal hooks	136
Entner, Ligature Needles	325
Entner, Liposuction Cannulas	24-27, 42
Enucleator	332
Epker Bauer, Osteotomes	249
Epker, Osteotomes	250
Erhardt, Ear Specula	167
Esophagoscopy	189-274
Ethmoid Bone Forceps, Craig-Domnick	199
Eves, Tonsil Snares	336

F

Fanous, Dissecting Scissors	73
Fanous, Osteotomes	257
Fanous, Rhinoplasty Scissors	91
Fanous-Gubisch, Osteotomes	257
Farabeuf, Nasal Retractors	143
Farabeuf-Baby, Nasal Retractors	143
Farrior, Ear Specula Storage Rack	168
Faulkner, Adenoid Curettes	232
Fergusson, Mouth Gags	276
Ferris -Smith- Cushing, Antrum Punches Forceps	211
Ferris - Smith- Cushing, Rongeur Forceps	211
Ferrozell Handle Dissectors	320
Finger Goniometer, Jameson	339
Finger Protector, Langen beck	286
Finsen, Self-retaining Retractors	160
Fisch, Micro Dissectors	174
Fisch, Micro Ear Hooks	174
Fisher, Tonsil Knives	331
Fistula hook	136
Fistula hook, Cottle	136
Fistula hook, Jackson	136
Fistula hook, News	136
Flap Knife, Plester	176
Flexometer, Moltgen	339
Fomon, Nasal Rasps	238,242,243
Fomon, Osteotomes	260
Fomon, Retractors	140,230
Fomon, Rhinoplastic & Nasal nives	213
Fomon, Rhinoplasty Scissors	85,87,90,91
Foot Surgery	128-132
Forceps	100-108
Forceps, Cottle	108
Forceps, DeBaKey	107
Forceps, Dressing & Tissue	103
Forceps, Duehrssen	103
Forceps, Fox	108
Forceps, Gillies	103
Forceps, Gruenwald	103
Forceps, Gruenwald - Jansen	103
Forceps, Hemostatic	124-126
Forceps, McIndoe	103
Forceps, Nelson	107

Forceps, Suturing	106
Forceps, Tissue Grasping	107,108
Forceps, Troeltsch (Wilde)	107
Forceps, Waugh	103
Forehead Retractors	322,323
Foreign Body Forceps, Buck	182
Foreign Body Forceps, Hartmann	182
Foreign Body Forceps, Litauer	182
Foreign Body Forceps, Tilley	182
Foreign Body Lever, Moldenhauer	178
Foreign Body Lever, Quire	182
Foreign Body Lever, Zaufal	178
Fox, Tissue Grasping Forceps	108
Frazier, Suction tubes	10, 11
Freeman Rake Retractor	141
Freeman-Mini Rake Retractor	141
Freer	225
Freer, Delicate Retractors	137
Freer, Nasal Hooks/ Nasal Retractors	229
Freer, Raspatories	214, 219
Freer, Rhinoplastic & Nasal nives	212
Freer, Rhinoplastic Chisels & Osteotomes	258
Freer, Septum Knives/ Septum Elevators	214
Freer, Spetum Chisels/ Spetum Gouge	225
Freer, Swivel Knives / Nasal Saws	225
French, Tuning Forks	165
Frental Sinus Graffe Forceps, Nasal Cuttin orceps	201
Frenzel, Tongue Depressors & Spatula	288
Fuller, Micro Ear Forceps	185
Furuncle Knife, Politzer	175

G

Gallaher, Bone Files	237
Gasparotti, Liposuction Cannulas with Thumb te	47,48
Gauze Packers, Luniatschek	333
Gillies, Arch Bar	231
Gillies, Delicate Retractors	134
Gillies, Dressing & Tissue Forceps	103
Gillies, Needle Holders	113,122
Giunta, Rhinoplasty Scissors	92
Glegg, Polypus Snares	196
Goldman, Periosteal Elevators	228
Goldman-Fox, Ligature Scissors	81
Gorrey-Freeman, Dissecting Scissors	76, 77
Gorney Rake Retractor	141
Gorney, Dissecting Scissors	75
Gorney, Rhinoplasty Scissors	98
Gouge, Hand & Foot Surgery	131
Gouges, Walter	261
Graft acker	215
Graft acker, Terry	215
Graig, Septum Forceps	199
Greenberg PAR, Delicate Dissecting Scissors	57
Greven, Wire Closure Forceps	188
Grid Plate, Marking & Measuring Instruments	340
Gross, Curettes & Scoop	177
Gruber, Ear Specula	167
Gruenwald (Jansen), Dressing & Tissue Forceps	103
Gruenwald (Jansen), Nasal Tampon Forceps	197
Gruenwald, Dressing & Tissue Forceps	103
Gubisch Cartila e Crusher	264
Gubisch, Needle Holders	121
Gubisch, Osteotomes	257
Gubisch, Suction Rasp tories	216
Gubisch-Aufricht, Nasal Retracto rs	148
Gubisch-Kilner, Retractors	142

Gum Scissors	79,80
Gum Scissors, Dean	79,80
Guthrie, Delicate Retractors	137
Guy, Tongue Holding Forceps	292

H

Hajek, Nasal Cutting orceps	205
Hajek, Sphenoid Bone Punches	210
Hajek-Kofler, Sphenoid Bone Punches	210
Halle, Antrum Curete	219
Halle, Septum Elevators	223
Halsey, Needle Holders	110, 119
Halsted-Micro, Hemostatic orceps	124
Halsted-Mosquito, Hemostatic Forceps	125
Hammer, Collin	245
Hammer, Combination Mallet Hammer,	246
Hammer Cottle	245
Hammer, Doyen	245
Hammer, Mallet Lightweight	246
Hammer, Partsch	246
Hand & Foot Surgery	128-132
Hand & Foot Surgery, Bone Awl	132
Hand & Foot Surgery, Bone Curetes	132
Hand & Foot Surgery, Bone File	131
Hand & Foot Surgery, Bone Hook	128
Hand & Foot Surgery, Bone Level Elevator	130
Hand & Foot Surgery, Chisel	131
Hand & Foot Surgery, Cushing Retractor	129
Hand & Foot Surgery, Gouge	131
Hand & Foot Surgery, Hohmann Retractor	129
Hand & Foot Surgery, Joseph Hook	128
Hand & Foot Surgery, Langenbeck Retractor	129
Hand & Foot Surgery, Meyerding Retractor	129
Hand & Foot Surgery, Miller Colburn Curetes	132
Hand & Foot Surgery, Osteotomes	131
Hand & Foot Surgery, Periosteal Elevator	130
Hand & Foot Surgery, Scalpel Handle	130
Hand & Foot Surgery, Senn Muller Hook	128
Handle for Cannulas	30
Handles for Cannulas	30,31
Hargis, Bone Holding Forceps	337
Hargis, Lip & Cheek Retractors	293
Hargis, Mobilizing Retractors	305
Hargis, Periosteal Elevators	221
Hargis, Rhinoplastic Chisels & Osteotomes	251
Hargis, Rim & Ramus Retractors	302
Hartmann Hoffmann, Ear Polypus Forceps	183
Hartmann Noyes, Ear Polypus Forceps	183
Hartmann Weingartner, Ear Polypus Forceps	183
Hartmann Wullstein, Ear Polypus Forceps	183
Hartmann, Cannulas	234
Hartmann, Ear Hooklet	178
Hartmann, Ear- Polypus Forceps	183
Hartmann, Ear Specula	167
Hartmann, Foreign Body Forceps	182
Hartmann, Nasal Cutting orceps	205
Hartmann, Nasal Polypus Forceps	198
Hartmann, Nasal Specula	191
Hartmann, Septum Compression Forceps	198
Hartmann, Syringes-Eustachian Catheters	170
Hartmann, Tongue Depressors	291
Hartmann, Tonsil	338
Hartmann, Tuning Forks	164,165
Hartmann, Halle, Nasal Specula	191
Harvesting of Cottle Cartilage, Cohen	213
Head Band, Diagnostics	346

Heaney, Nasal Retractors	144,145
Hegar-Baumgartner, Needle Holders	110, 119
Heister, Mouth Gag	277
Hemostatic orceps	124, 126
Hemostatic orceps, Providence-Hospital	125
Hemostatic orceps, Crile	126
Hemostatic orceps, Diethrich	124
Hemostatic orceps, Halsted-Mosquito	125
Hemostatic orceps, Jacobson-Mosquito	125
Hemostatic orceps, Kelly	126
Hemostatic orceps, Leriche	126
Hemostatic orceps, Micro-Halsted	124
Hemostatic orceps, Micro-Jacobson	125
Hemostatic orceps, Mosquito	124
Henckel, Nasal Cutting orceps	203
Henke	332
Heymann, Rhinoplasty & Nasal Knives	212
Heymann, Rhinoplasty Scissors	88, 89
Heymann, Septum Forceps	199
Heymann-Knight, Nasal Polypus Forceps	198
Heymann-Knight, Septum Compression Forceps	198
Hill, Septum Knives/ Septum Elevators	214
Hohmann Retractor, Hand & Foot Surgery	129
Holding Device for Cannulas, Liposuction	30
Hook, Blocksma	271
House Gelfoam Press	304
House Suction	11
House, Micro Curetes	175
House, Micro Measuring Rod	174
House-Dieter, Micro Ear Forceps	185
Howarth, Septum Knives / Septum Elevators	214
Hudson-Ewald, Delicate Forceps	100
Humby, Delicate Retractors	134
Humby, Dermatomes	344
Hurd, Packer Retractors	332
Hurd, Throat Retractors & Dissectors	333
Hurd, Tonsil Needle	330

I

Iliac Crest Retractors	311
Infiltration of theumescense	46
Instruments for Auricular Plastic	326
Instruments for Auricular Plastic, Do en	326
Intra Oral Retractors	307, 310
Intra Oral Retractors, Shea	309
Iris, Delicate Dissecting Scissors	56
Iris-Fine, Delicate Scissors	50
Iris-Kilner, Delicate Scissors	51
Iris-Micro, Delicate Scissors	51
Irrigating Tubes, Suctionubes	11

J

Jaboma, Cleft alate Periosteal Elevator	220
Jackson, -Delicate Retractors, Double-Ended	146
Jackson, Fistula hook	136
Jacobson, Micro Scissors	95
Jacobson - Micro, Hemostatic orceps	125
Jacobson-Mosquito, Hemostatic orceps	125
Jaeger, Lid Plate	289
Jameso Calipers	339
Jameson, Finger Goniometer	339
Jansen Guenwald, Dressing & Tissue Forceps	103
Jansen, Micro Curetes	175
Jansen, Nasal Tampon Forceps	197
Jansen-Struycken, Septum Scissors	208

Jenning, Mouth Gags	286
Joseph	225
Joseph Hook, Hand & Foot Surgery	128
Joseph, Delicate Dissecting Scissors	58
Joseph, Delicate Retractors	137
Joseph, Nasal Hooks	229
Joseph, Nasal Rasps	238
Joseph, Nasal Retractors/ Alar Hooklets	229
Joseph, Nasal Saws	226
Joseph, Rhinoplastic & Nasal nives	212
Joseph, Septum Cartila e Knife	213
Joseph, Septum Elevators	223
Joseph, Swivel Knives	225,226,229
Joseph-Masing, Septum Elevators/ Periosteal Elevators	224

K

Kahre, Knife	271
Kaye, Dissecting Scissors	73, 74
Keen, Bone Holding Forceps	337
Kelly, Dissecting Scissors	67
Kelly, Hemostatic orceps	126
Kelly, Stich Scissors	82
Kerrison, Sphenoid Bone Punches	210
Killian, Cannulas	234
Killian, Nasal Polypus Forceps	198
Killian, Nasal Specula	193,195
Killian, Rhinoplastic Chisels & Oteotomes	258
Killian, Rhinoplasty Scissors	97
Killian, Septum Compression Forceps	198
Killian, Septum Elevators	223
Killian, Septum Gouges/ Chisels	225
Killian, Septum Scissors	207
Killian-Claus, Rhinoplastic Chisels & Oteotomes	258
Killian-Claus, Septum Gouges/ Chisels	225
Kilner Doughty, Mouth Gags	278,281,283
Kilner, Nasal Retractors	229
Kilner, Needle Holders	113, 121
Kilner, Retractors	142
Kleinert-Kutz, Skin Hooks	135
Knapp, Delicate Dissecting Scissors	54- 56
Knife, Kahre	271
Knife, McIndoe	271
Knight, Septum Forceps	199
Knives	328
Knives, Bayonet shape	328
Knives, Rhinoplastic & Nasal	213
Koberg, Mod, Retractors	140,230
Kocher, Retractors	151
Konig, Tuning Forks	166
Kotzur, Liposuction Cannulas	23
Krause, Polypus Snares	196
Krause-Voss, Polypus Snares	196
Kressner, Septum Forceps	266
Krieg, Rhinoplastic & Nasal nives	212

L

Lack, Tongue Depressors	291
Landolt, Scalpels	8
Lane Periosteal Elevator	217
Lange, Alar Hooklet	290
Langenbeck Retractor, Hand & Foot Surgery	129
Langenbeck, Finger Protector	286
Langenbeck, Micro Curetes	175
Langenbeck, Periosteal Elevators	227
Langenbeck, Retractors	151

Lange-Wilde, Polypus Snares	196
La Roe Tissue Spreaders	267
LeFort I Retractors, Arnhem	303
Lempert, Ear Periosteal Elevators	180
Lempert, Ear Scoops	180
Lempert, Raspatories	219
Leriche, Hemostatic orceps	126
Lewis, Nasal Rasps/ Bone Files	237, 239
Lexer, Dissecting Scissors	69
Lexer-Baby, Delicate Dissecting Scissors	54
Lexer-Fino, Dissecting Scissors	70
Lid Plate , Jaeger	289
Ligature Needles	325
Ligature Needles, Entner	325
Ligature Scissors	81
Ligature Scissors, Goldman-Fox	81
Lip & Cheek Retractors, Bishop	289
Lip & Cheek Retractors, Hargis	293
Lip & Cheek Retractors, Obwegeser	289
Lip & Cheek Retractors, Oringer	287
Lip & Cheek Retractors, Simplex	289
Lip & Cheek Retractors, Sternberg	289
Liposuction	14-48
Liposuction Cannulas	14-29, 32-44
Liposuction Cannulas with Thumb Pl te	47,48
Liposuction Cannulas with Thumb Pl te, Gasparrotti	47,48
Liposuction Cannulas, E tner	24-27, 42
Liposuction Cannulas, otzur	23
Liposuction Cannulas, Mercedes	28 , 43
Liposuction Cannulas, oledo	29,44
Liposuction, Adapor for Cannulas	30
Liposuction, Holding Device	30
Liposuction, Sop (Lock)	30
Liposuction, ransfer Adaptor for Cannulas	30,31
Litauer, Foreign Body Forceps	182
Litauer, Nasal Polypus Forceps	198
Litauer, Septum Compression Forceps	198
Litauerr, Stch Scissors	82
Little, Rhinoplasty Scissors	83
Local Anaesthesia Solution	46
Lubet-Barbon, Septum Forceps	199
Luc, Septum Forceps	200
Lucae, Ear Hooklets	179
Lucae, Nasal Tampon Forceps	197
Lucae, Syringes-Eustachian Catheters	170
Lucae , Tuning Forks	166
Lucae, Tympanum Needles	177
Luc-Brunings (Heymann), Septum Forceps	200
Luniatschek, Dissectors, Retractors, Gauze Packers	333
Lynch, Tonsil Knives	331

M

MacCollum Dingman, Breast Retractors	313
MacCollum, Breast Retractors	313
Mallet Lightweight, Hammer	246
Mallets	245,246
Maltz, Nasal Rasps	238
Mandibular Retractors, Obwegesser	301
Mandibular Retractors, Steinhauer	301
Marchac, Bone Contouring Forceps	209
Marchac, Cannulas	234
Marchac, Disimpaction orceps	270
Marchac, Periosteal Elevators	222
Marchac, Ramus Osteotomes, Chisels	253
Marchas, Rhinoplastic Chisels & Oteotomes	248
Marker, Areola	315

Marking & Measuring Instruments, Bertillon	340	Micro Ear Hooks, Fisch	174
Marking & Measuring Instruments, Castroviejo	341	Micro Ear Hooks, McGee	173
Marking & Measuring Instruments, Castroviejo-Epker	342	Micro Ear Hooks, Rosen	173,174
Marking & Measuring Instruments, Grid Plate	340	Micro Ear Hooks, Shambaugh	174
Marking & Measuring Instruments, Jameson	339	Micro Ear Hooks, Shea	174
Marking & Measuring Instruments, Mbltgen	339	Micro Ear Knives, Schuknecht	176
Marking & Measuring Instruments, Ruler	339	Micro Ear Needles, Barbara	173
Marking & Measuring Instruments, Thole	340	Micro Ear Needles, McGee	173
Marking & Measuring Instruments, Townley	340	Micro Ear Needles, Rosen	173
Marking Instruments	339,342	Micro Ear Scissors, Bellucci	187
Marx, Breast Retractors	316	Micro Ear Scissors, Wullstein	187
Masing, Delicate Retractors, Double-Ended	146	Micro Forceps	104-106
Masing, Nasal Rasps	244	Micro Measuring Rod, House	174
Masing, Septum Elevators/ Periosteal Elevators	224	Micro Needle Holders	114, 118
Mason, Mouth Gags	276	Micro Needle Holders, Barraquer	116,117
Mastoid Ear Searcher, Ear Hooklets	179	Micro Needle Holders, Castroviejo	114
Mastoid Rongeurs, Beyer	188	Micro Needle Holders, Castroviejo - Micro	115
Mastoid Rongeurs, Citelli	188	Micro Scissors	94-96
Mathieu, Needle Holders	123	Micro Scissors, Jacobson	95
Mathieu, Tongue Holding Forceps	292	Micro Scissors, Standard	95, 96
Maxio Facial Surgery	189-274	Micro-Adson, Delicate Forceps	101
Mayo, Dissecting Scissors	71	Micro-Halsted, Hemostatic forceps	124
Mayo, Tongue Depressors & Spatula	288	Micro-Iris, Delicate Scissors	51
Mayo-Hegar, Needle Holders	111,120	Micro-Jacobson, Hemostatic forceps	125
Mayo-Lexer, Dissecting Scissors	69	Middleton-Jansen, Septum Forceps	208
Mayo-Stillé, Dissecting Scissors	71	Middleton-Jansen, Septum Scissors	208
McGee, Micro Ear Hooks	173	Millard (Cottle), Retractors	140
McGee, Micro Ear Needles	173	Miller Colburn Curettes, Hand & Foot Surgery	132
McGee, Micro Wire Biting Forceps	185	Miller-Colburn, Nasal Rasps	240,241
McGee-Mini, Micro Ear Forceps	184	Miller-Colburn, Osteotomes	241
McKenty, Periosteal Elevators	222	Mini Gillies, Needle Holders	113, 122
McKenty, Septum Elevators	223	Mini- Metzenbaum, Delicate Dissecting Scissors	60
McIndoe, Dressing & Tissue Forceps	103	Moberg, Ramus Osteotomes, Chisels	254
McIndoe, Knife	271	Mobilizing Retractors, Dingmann Wilk	305
McIndoe, Ramus Osteotomes, Chisels	254	Mobilizing Retractors, Hargis	305
McIndoe, Rhinoplasty Scissors	86	Mod. Crushing Plier	264
McIovr, Mouth Gags	279	Mod. Nasal Specula, Nasal Specula	191
McWhorter-Lothrop, Tonsil Seizing Forceps	335	Moldenhauer, Foreign Body Lever	178
Measuring Instruments	339-342	Molt/ Doyen, Mouth Gags	276
Measuring Instruments, Thorpe	339	Moltgen, Flexometer	339
Mercedes, Liposuction Cannulas	28,43	Mosquito, Hemostatic forceps	124
Mershon, Wire Instruments	343	Mouth Gags, Boyles	284
Mershon, Wire Pushers	231	Mouth Gags, Buxton	277
Metz, Progency Retractors	298	Mouth Gags, Davis Boyle	278,282
Metzenbaum - Freeman, Dissecting Scissors	72	Mouth Gags, Delabarre	277
Metzenbaum, Dissecting Scissors	61, 72	Mouth Gags, Denhart	276
Metzenbaum, Needle Holders	112	Mouth Gags, Dingmann	280,285
Metzenbaum-Fino, Delicate Dissecting Scissors	62	Mouth Gags, Fergusson	276
Metzenbaum-Fino, Dissecting Scissors	63,64	Mouth Gags, Heister	277
Meyerding Retractor, Hand & Foot Surgery	129	Mouth Gags, Jenning	286
Meyerding, Delicate Retractors	147	Mouth Gags, Kilner Doughty	278,281,283
Micro Cup-Shaped-Forceps, Alligator	186	Mouth Gags, Mason	276
Micro Curettes, House	175	Mouth Gags, McIovr	279
Micro Curettes, Jansen	175	Mouth Gags, Molt/ Doyen	276
Micro Curettes, Langenbeck	175	Mouth Gags, Roser-Konig	276
Micro Curettes, Shapleigh	175	Mouth Gags, Terrier	277
Micro Dissectors, Austin	174	Mouth Gags, Whitehead	286
Micro Dissectors, Fisch	174	Mucoperiost Retractor	272
Micro Dissectors, Rosen	174	Mucosa Knife, Tabb	176
Micro Dissectors, Shambaugh	174	Mucotome	346
Micro Dissectors, Shea	174	Museum, Abscess Forceps	334
Micro Ear Forceps, Alligator	186	Museum, Tonsil Seizing Forceps	335
Micro Ear Forceps, Fuller	185	Myles, Adenoid Curettes	232
Micro Ear Forceps, House-Dieter	185	Myles, Ear Curettes	181
Micro Ear Forceps, McGee-Mini	184	Myles, Nasal Cutting forceps	205
Micro Ear Hooks, Austin	174		
Micro Ear Hooks, Barbara	173		

Obwegeser, Lip & Cheek Retractors	289
Obwegeser, Nasal Rasps	244
Obwegeser, Osteotomes	262
Obwegeser, Osteotomes & Maxillary Mobilizer	255
Obwegeser, Periosteal Elevators	217, 218, 221
Obwegeser, Ramus Osteotomes, Chisels	253
Obwegeser, Retractors	153-159
Obwegeser, Rhinoplastic Chisels & Osteotomes	251
Obwegeser, Rhinoplasty Scissors	98
Obwegeser, Rib Raspatories	222
Obwegeser, Rim & Ramus Retractors	302
Obwegeser, Septum Forceps	206
Obwegeser, Soft Tissue Retractors	296,297
Obwegeser, Wire Instruments	343
Obwegeser, Wire Loop Forceps	343
Obwegeser-Freer, Elevators	215
Obwegesser, Mandibular Retractors	301
Obwegesser, Nasal Spine Retractors	299,300
Obwegesser, Ramus Retractors	299,300
Ogura, Skin Grasping Forceps	266
Olsen-Hegar, Needle Holders	113
Oral Instruments	275-328
Oral Maxillo Facial Surgery	215,235,236, 295-299
Oringer, Lip & Cheek Retractors	287
Osteotomes	262,263
Osteotomes & Maxillary Mobilizer, Cottle	255
Osteotomes & Maxillary Mobilizer, Obwegeser	255
Osteotomes & Maxillary Mobilizer, Steinhauser	255
Osteotomes & Maxillary Mobilizer, Wolford	255
Osteotomes, Bauer	249
Osteotomes, Blume	257
Osteotomes, Cinelli,	260
Osteotomes, Dautrey Munro	249
Osteotomes, Dunn Dautrey	250
Osteotomes, Epker	250
Osteotomes, Epker Bauer	249
Osteotomes, Fanous	257
Osteotomes, Fanous-Gubisch	257
Osteotomes, Fomon	260
Osteotomes, Gouges, Cartila e Crusherr, Cottle	261
Osteotomes, Gubisch	257
Osteotomes, Hand & Foot Surgery	131
Osteotomes, Miller-Colburn	241
Osteotomes, Neivert-Anderson	260
Osteotomes, Obwegeser	262
Osteotomes, Rubin	261
Osteotomes, Schrom	257
Osteotomes, Sheehan	260
Osteotomes, Steinhauser	261
Osteotomes, Tessier	256
Osteotomes, Tessier	262,263
Osteotomes, Walter	261
Otology	163-188

P

Packer Retractors	332
Packer Retractors, Hurd	332
Palatal Expander, Tessier	305
Palatal Expander, Turvey	304
Parkes, Rhinoplastic Chisels & Osteotomes	258
Partsch, Hammer	246
Passway Dissector	314
Peck-Joseph, Delicate Dissecting Scissors	59
Pennington, Septum Elevators/ Periosteal Elevators	224
Periosteal Elevator, Hand & Foot Surgery	130
Periosteal Elevators, Boies	228

Periosteal Elevators, Converse	221
Periosteal Elevators, Cottle	224,228
Periosteal Elevators, Goldman	228
Periosteal Elevators, Hargis	221
Periosteal Elevators, Joseph-Masing	224
Periosteal Elevators, Lane	217
Periosteal Elevators, Langenbeck	227
Periosteal Elevators, Marchac	222
Periosteal Elevators, Masing	224
Periosteal Elevators, McKenty	222
Periosteal Elevators, Obwegeser	217,218,221
Periosteal Elevators, Pennington	224
Periosteal Elevators, Roger	224
Periosteal Elevators, Steinhauser	217,218
Periosteal Elevators, Tessier	227
Periosteal Elevators, Williger	218
Periosteal Elevators, Yankauer	228
Pimeroy, Syringes-Eustachian Catheters	169
Plester, Flap Knife	176
Politzer, Air Bags	172
Politzer, Ear Specula	167
Politzer, Furuncle Knife	175
Politzer, Tympanum Needles	177
Polako fRasp, Nasal Rasp	241
Polypus Snares, Glegg	196
Polypus Snares, Krause	196
Polypus Snares, Krause-Voss	196
Polypus Snares, Lange-Wilde	196
Pritchard, Ear Specula	167
Progency Retractors, Metz	298
Progency Retractors, Schuchardt	298
Providence- Hospital, Hemostatic Forceps	125

Q

Quire, Foreign Body Lever	182
---------------------------	-----

R

Ragnell (Kilner), Delicate Dissecting Scissors	57
Ragnell-Davis, Delicate Retractors, Double-Ended	146
Ramus Osteotomes & Chisels	254
Ramus Osteotomes , Chisels, Marchac	253
Ramus Osteotomes , Chisels, Mcindoe	254
Ramus Osteotomes , Chisels, Moberg	254
Ramus Osteotomes , Chisels, Obwegeser	253
Ramus Osteotomes , Chisels, Steinhauser	253
Ramus Osteotomes, Chisels, Walter	253
Ramus Pusher, Terry	302
Ramus Retractors, Obwegesser	299,300,302
Raspatories	218, 219, 271, 273, 319
Raspatories with Novotex Handle	319
Raspatories, Durham	214
Raspatories, Freer	214
Raspatories, Freer	219
Raspatories, Hill	214
Raspatories, Howarth	214
Raspatories, Lempert	219
Raspatories, Walter	219
Raspatories, Wang	273
Redon, Suction Tubes	12
Retractor for Lipoabdominoplasty	317
Retractor, Coronal Brow Lift	141
Retractor, Freeman	141
Retractor, Freeman-Mini	141
Retractor, Gorney Rake Retractor	141
Retractor, Yancoskie	141

Scissors, Converse	84	Septum Elevators, Killian	223
Scissors, Cottle	84, 90,98	Septum Elevators, Masing	224
Scissors, Cottle-Masing	83	Septum Elevators, McKenty	223
Scissors, Fanous	91	Septum Elevators, Pennington	224
Scissors, Fomon	85,87	Septum Elevators, Roger	224
Scissors, Giunta	92	Septum Forceps, Aiach	206
Scissors, Goldman-Fox	81	Septum Forceps, Bruenings	200
Scissors, Gorney	75,98	Septum Forceps, Graig	199
Scissors, Greenberg PAR	57	Septum Forceps, Heymann	199
Scissors, Gum	79,80	Septum Forceps, Jansen-Struycken	208
Scissors, Iris	56	Septum Forceps, Knight	199
Scissors, Iris-Kilner	51	Septum Forceps, Kressner	266
Scissors, Iris-Micro	51	Septum Forceps, Lubet-Barbon	199
Scissors, Jacobson	95	Septum Forceps, Luc	200
Scissors, Joseph	58	Septum Forceps, Luc-Brunings (Heymann)	200
Scissors, Kelly	67,82	Septum Forceps, Middleton-Jansen	208
Scissors, Killian	97	Septum Forceps, Obwegeser	206
Scissors, Knapp	54,56	Septum Forceps, Rubin	208
Scissors, Lexer	69	Septum Forceps, Septum Straightening Forceps,	266
Scissors, Lexer-Baby	54	Skin Grasping Forceps, Cottle	
Scissors, Ligature	81	Septum Forceps, TC-Rubin	208
Scissors, Litauer	82	Septum Gouges / Chisels, Killian	225
Scissors, Littler	83	Septum Gouges/ Chisels, Killian-Claus	225
Scissors, Mayo	71	Septum Knives/Septum Elevators, Durham	214
Scissors, Mayo-Lexer	69	Septum Knives/Septum Elevators, Freer	214
Scissors, Mayo-Stille	71	Septum Knives/Septum Elevators, Hill	214
Scissors, McIndoe	86	Septum Knives/Septum Elevators, Howarth	214
Scissors, Metzenbaum	61, 72	Septum Scissors, Caplan	207
Scissors, Metzenbaum - Freeman	72	Septum Scissors, Jansen-Struycken	208
Scissors, Micro, Standard	95,96	Septum Scissors, Killian	207
Scissors, Mini- Metzenbaum	60	Septum Scissors, Middleton-Jansen	208
Scissors, O'Brien	82	Sets, Liposution Cannulas	45
Scissors, Obwegeser	98	Shambaugh, Micro Dissectors	174
Scissors, Peck-Joseph	59	Shambaugh, Micro Ear Hooks	174
Scissors, Ragnell (Kilner)	57	Shapleigh, Micro Curetes	175
Scissors, Reynolds (Jameson)	68	Shea, Intra Oral Retractors	309
Scissors, Rhinoplasty	83, 93, 97,98	Shea, Micro Dissectors	174
Scissors, Siegert	58	Shea, Micro Ear Hooks	174
Scissors, Spencer	82	Sheehan, Osteotomes	260
Scissors, Stevens	52, 53	Sheehy Fascia Press	304
Scissors, Stevens-Gradle	56	Sickle Knives, Schuknecht	176
Scissors, Stich	82	Sickle Knives, Wullstein	176
Scissors, Toennis-Adson	67	Siebenmann, Antrum Cannula	290
Scissors, Utility	56	Siegert, Delicate Dissecting Scissors	58
Scissors, Walter	87	Siegle, Syringes-Eustachian Catheters	169
Scissors, Walter-Cottle	92	Silver Chisel Osteotome	252
Scissors, Zouor	78	Silver Chisel Osteotome, Rhinoplastic Chisels & Oteotomes	247
Scissors, Zouor Modified	78	Silver, Dermatomes	345
Self-Retaining Retractors	160-162	Silver, Rhinoplastic Chisels & Oteotomes	247
Self-Retaining Retractors, Weitlaner	161,162	Simplex, Lip & Cheek Retractors	289
Semken, Delicate Forceps	102, 103	Sinus Forceps, Nasal Cutting orceps	202
Semken, Dressing & Tissue Forceps	102,103	Sinus Lift Cueees	235,236
Senn Muller Hook, Hand & Foot Surgery	128	Sinus Lift etractors, Arnhem	303
Senn-Green, Delicate Retractors	147	Sinus Stammberger, Nasal Cutting orceps	201
Senning, Needle Holders	113, 122	Skin Grasping Forceps, Ogura	266
Senn-Miller, Delicate Retractors, Double-Ended	146	Skin Hooks	135
Septum Cartila e Knife, Joseph	213	Skin Hooks, Barsky	135
Septum Compression Forceps, Hartmann	198	Skin Hooks, Benicke	135
Septum Compression Forceps, Heymann-Knight	198	Skin Hooks, Kleinert-Kutz	135
Septum Compression Forceps, Killian	198	Sluder-Ballenger, Tonsil	338
Septum Compression Forceps, Litauer	198	Smith, Retractors	306
Septum Compression Forceps, Westmacott	198	Soft Tissue etractors	155,156
Septum Elevators, Ballenger-Hajek	223	Soft Tissue etractors, Obwegeser	296,297
Septum Elevators, Cottle	223,224	Soft Tissue etractors, Tessier	294,295
Septum Elevators, Halle	223	Solz, Areola Marker	315
Septum Elevators, Joseph	223	Solz, Breast Dissectors	312
Septum Elevators, Joseph-Masing	224	Solz, Navel Marker	318

Spare Blade For Dermatomes	344,345	Tebbetts,	
Spatula Dissector	314	Terrier, Mouth Gags	277
Spatula, Breast Dissectors	312	Terry, Chin, Channel & Ramus Retractors	293
Specula, Siegle	169	Terry, Elevators	215
Spencer, Stich Scissors	82	Terry, Graft acker	215
Spetum Chisels, Freer	225	Terry, Ramus Pusher	302
Spetum Gouge, Freer	225	Terry, Rhinoplastic Chisels & Oteotomes	251
Sphenoid Bone Punches, Hajek	210	Tessier, Adenoid Curetes	232
Sphenoid Bone Punches, Hajek-Kofler	210	Tessier, Bone Contouring Forceps	209
Sphenoid Bone Punches, Kerrison	210	Tessier, Disimpaction orceps	270
Spreading Forceps, Tessier	304	Tessier, Nasal Specula	195
St. Clair Thomson, Nasal Specula	190	Tessier, Osteotomes	256,262,263
St. Clair-Thomson, Adenoid Curetes	234	Tessier, Palatal Expander	305
Stammerberger, Nasal Cutting orceps	201,205	Tessier, Periosteal Elevators	227
Standard, Micro Scissors	95,96	Tessier, Soft Tissue etractors	294,295
Standard, Scalpel Handles	2, 3	Tessier, Spreading Forceps	304
Steinhauser, Extra Long Channel Retractors	306	Tessier, T horacic Retractors	311
Steinhauser, Mandibular Retractors	301	T hilenius, Tonsil Seizing Forceps	335
Steinhauser, Osteotomes	261	T hole, Marking & Measuring Instruments	340
Steinhauser, Osteotomes & Maxillary Mobilizer	255	T horacic Retractors	311
Steinhauser, Periosteal Elevators	217,218	T horacic Retractors, Tessier	311
Steinhauser, Ramus Osteotomes, Chisels	253	Thorpe, Calipers	339
Steinhauser, Raspatories	219	T hroat Retractors, Hurd	333
Sternberg, Lip & Cheek Retractors	289	T ieck-Halle, Nasal Specula	191
Sternberg, Retractors	274	Tilley, Foreign Body Forceps	182
Stevens, Delicate Scissors	52,53	T issue Grasping Forceps	107,108
Stevens-Gradle, Delicate Dissecting Scissors	56	T issue Grasping Forceps , DeBakey	107
Stich Scissors	82	T issue Grasping Forceps, Cottle	108
Stich Scissors, Kelly	82	T issue Grasping Forceps, Fox	108
Stich Scissors, Liauer	82	T issue Grasping Forceps, Nelson	107
Stich Scissors, O'Brien	82	T issue Grasping Forceps, Troeltsch (Wilde)	107
Stich Scissors, Spencer	82	T issue Grasping Forceps, Walter	107,108
Stop (Lock) for Cannulas, Liposuction	30	T ivnen-Tyding, Tonsil Seizing Forceps	335
Struempel, Ear Polypus Forceps	183	Tobold, Tongue Depressors & Spatula	288,291
Struycken, Nasal Cutting orceps	203	Toennis-Adson, Dissecting Scissors	67
Suction Adaperr, Suctionubes	12	Toledo, Liposuction Cannulas	29,44
Suction House	11	Tongue Depressors & Spatula, Bruenings	288
Suction Rasp oratories	216	Tongue Depressors & Spatula, Buchwald	288
Suction Rasp oratories, Gubisch	216	Tongue Depressors & Spatula, Collin	288
Suction ubes	10-12	Tongue Depressors & Spatula, Doyen	288
Suction ubes, Adson	10	Tongue Depressors & Spatula, Frenzel	288
Suction ubes, Baron	11	Tongue Depressors & Spatula, Mayo	288
Suction ubes, Frazier	10, 11	Tongue Depressors & Spatula, Tobold	288
Suction ubes, Irrigaatingubes	11	Tongue Depressors, Bosworth	291
Suction ubes, Redon	12	Tongue Depressors, Hartmann	291
Suction Tubes, Suction Adaer	12	Tongue Depressors, Lack	291
Suction Tubes, Suction House	11	Tongue Depressors, Tobold	291
Suction Tubes, Unit Audite	11	Tongue Depressors, Wieder	291
Suction ubes, Yasargil	10	Tongue Holding Forceps, Collin	292
Super, Scalpel Handles	5	Tongue Holding Forceps, Guy	292
Suturing Forceps	106	Tongue Holding Forceps, Mathieu	292
Swallowtail Raspatories	218	Tongue Holding Forceps, Young	292
Swivel Knives, Ballenger	225	Tonsil	329-338
Swivel Knives, Freer	225	Tonsil Haemostatic, Schnidt	334
Swivel Knives, Joseph	225,226	Tonsil Knives, Abraham	331
Syringes-Eustachian Catheters, Hartmann	170	Tonsil Knives, Canfield	331
Syringes-Eustachian Catheters, Lucae	170	Tonsil Knives, Carpenter	332
Syringes-Eustachian Catheters, Pimeroy	169	Tonsil Knives, Colver	331
Syringes-Eustachian Catheters, Siegle	169	Tonsil Knives, Day	331
Syringes-Eustachian Catheters, Troeltsch	170	Tonsil Knives, Douglas	331
Syringes-Eustachian Catheters, Woakes	170	Tonsil Knives, Fisher	331
T		Tonsil Knives, Lynch	331
Tabb, Mucosa Knife	176	Tonsil Knives, Tyding	331
Takahashi, Nasal Cutting orceps	203	Tonsil Needle, Dupuy-Weiss	330
TC-Rubin, Septum Forceps	208	Tonsil Needle, Durham	330
		Tonsil Needle, Hurd	330
		Tonsil Seizing Forceps, Blohmke	335

Tonsil Seizing Forceps, Denis-Browne	335	Weil-Blakesley, Nasal Cutting Forceps	204
Tonsil Seizing Forceps, McWhorter-Lothrop	335	Weitlaner, Self-Retaining Retractors	161,162
Tonsil Seizing Forceps, Museum	335	Westmacott, Nasal Olypus Forceps	198
Tonsil Seizing Forceps, Thilenius	335	Westmacott, Septum Compression Forceps	198
Tonsil Seizing Forceps, Tivnen-Tyding	335	White, Abscess Forceps	334
Tonsil Snare, Bruenings	336	Whitehead, Mouth Gags	286
Tonsil Snare, Eves	336	Wieder, Tongue Depressors	291
Tonsil Snare, Tyding	336	Wiener, Nasal Rasps	238
Tonsil, Hartmann	338	Williger, Periosteal Elevators	218
Tonsil, Sluder-Ballenger	338	Williger-Walter, Curete	219
Townley, Calipers	340	Wire Bening Forceps, Micro, McGee	185
Toynbee, Ear Specula	167	Wire Closure Forceps, Greven	188
Tracheal hooks	136	Wire Cutting Scissors	343
Tracheal hooks, Bergmann	136	Wire Instruments, Mershon	343
Tracheal hooks, Emmet	136	Wire Instruments, Obwegeser	343
Tracheal hooks, Jackson	136	Wire Loop Forceps, Obwegeser	343
Tracheal hooks, News	136	Wire Pushers, Dingmann	231
Transfer Adaptor for Cannulas, Liposuction	30,31	Wire Pushers, Mershon	231
Troeltsch (Wilde), Ear Forceps	197	Wire Pushers, Rowe	231
Troeltsch (Wilde), Tissue Grasping Forceps	107	Wires & Wire Instruments	343
Troeltsch, Ear Forceps	197	Woakes, Syringes-Eustachian Catheters	170
Troeltsch, Ear Specula	167	Wolford, Bone Holding Forceps	337
Troeltsch, Syringes-Eustachian Catheters	170	Wolford, Osteotomes & Maxillary Mobilizer	255
Troeltsch, Tympanum Needles	177	Wright (Derf), Needle Holders	110
Tuning Forks, French	165	Wullstein, Micro Ear Scissors	187
Tuning Forks, Hartmann	164,165	Wullstein, Sickle Knives	176
Tuning Forks, Konig	166		
Tuning Forks, Lucae	166	Y	
Tuning Forks, Rydel-Seiffert	166	Yancoskie Abdominoplasty Retractor	141
Turvey, Palatal Expander	304	Yankauer, Nasal Specula	190
Tyding, Tonsil Knives	331	Yankauer, Periosteal Elevators	228
Tyding, Tonsil Snare	336	Yasargil, Suction Tubes	10
Tympanum Needles, Lucae	177	Young, Tongue Holding Forceps	292
Tympanum Needles, Politzer	177		
Tympanum Needles, Troeltsch	177	Z	
		Zaufal, Foreign Body Lever	178
U		Zollner, Ear Specula Storage Rack	168
Unit Auditive, Suctiontubes	11	Zouor Modified, Dissecting Scissors	78
Utilit, Delicatte Dissecting Scissors	56	Zouor, Dissecting Scissors	78
V			
Vacher, Nasal Specula	190		
Vestbulum Retractor	274		
Vienna, Nasal Specula	192		
Voltolini, Nasal Specula	190		
W			
Wagener, Ear Hooklets	179		
Walsham (Universal), Disimpaction Forceps	268		
Walter, Gouges	261		
Walter, Osteotomes	261		
Walter, Ramus Osteotomes, Chisels	254		
Walter, Raspatories	219		
Walter, Retractors	142		
Walter, Rhinoplasty Scissors	87		
Walter, Tissue Grasping Forceps	107,108		
Walter-Cottle, Rhinoplasty Scissors	92		
Wang, Raspatories	273		
Watson, Dermatomes	344		
Watson-Williams, Nasal Cutting Forceps	203		
Waugh, Dressing & Tissue Forceps	103		
Weber-Loch, Ear Loop	178		
Webster, Needle Holders	111,119		
Weighted Nasal Hook, Retractors	140		



Contact us:

530 Commerce Avenue Suite D, Palmdale, CA, 93551

Customer Service 1-877-785-7770

**Info@medxdistribution.com
www.medxdistribution.com**